

SCU Series FSoE Master and Slaves



**Read and observe installation manual before initial
commissioning/initial startup/ integration of the module!**

Observe safety instructions!

Keep for future use!

Installation manual for SCU series devices

Status: 03/2024

INFORMATION

The German version is the original Version of the installation manual.

- ➔ Contact the manufacturer immediately if the instructions are missing!
- ➔ Always keep the manual at hand!
- ➔ Make sure that the manual is complete!
- ➔ Obtain this document only through the original publisher!

Subject to technical changes!

The content of this documentation has been compiled with the utmost carefulness, and corresponds to our current state of information. Nevertheless, we point out that the technical update of this documentation cannot always be carried out simultaneously with the technical evolution of our products.

Information and specifications can always be changed. For the current version, please refer to www.bbh-products.de.

Manufaturer BBH Products

BBH Products GmbH
Böttgerstraße 40
92637 Weiden
GERMANY

1. Inventories

1.1. Table of contents

1. Inventories	3
1.1. Table of contents	3
1.2. Table of illustrations	8
1.3. List of tables	10
2. Basic information	11
2.1. Identification	11
2.2. Important information for use	11
2.3. Warranty claims	12
2.4. Liability exclusion	12
2.5. Copyright	12
2.6. Brands	12
2.7. Supplied documents	13
2.8. Symbols and signal words	14
2.8.1. Safety information	14
3. Safety	15
3.1. General safety information	15
3.2. Target group	16
3.3. Terms	18
3.4. Relevant standards and directives	19
3.5. Intended use	20
3.6. Storage and transport	21
3.7. Placement	22
3.8. Electrical connection	23
3.9. Behaviour in case of emergencies	24
3.10. Safe status	24
3.11. Scope of delivery SCU	25
3.12. Labelling / rating plate SCU	26
3.12.1. Rating plate SSB-x-x-x	27
4. Use.....	28
4.1. Device description	28
4.1.1. Function	28
4.1.2. Embedding into the EtherCAT network and into FSoE	29
4.1.2.1. FSoE data transfer	29
4.1.2.2. EtherCAT network	29

4.1.2.3.	EtherCAT data transfer	30
4.1.2.4.	FSoE and EtherCAT	30
4.1.3.	The principle of safe monitoring with SCU	32
4.2.	Operation and service	32
5.	General structure of the series.....	33
5.1.	FSoE Master (SCU)	33
5.2.	FSoE-Slaves (SDU, SIO, SSB)	34
5.2.1.	SDU-x	34
5.2.2.	SIO-x	36
5.2.3.	SSB-x-x-x	37
5.3.	Encoder specifications	38
6.	Technical specifications of the SCU series.....	40
6.1.	SCU Master	40
6.1.1.	SCU-0-EC/x	40
6.1.2.	SCU-1-EC/x	40
6.1.3.	SCU-2-EC/x	40
6.2.	SCU Slaves	40
6.2.1.	SDU-11	40
6.2.2.	SDU-11/NM	40
6.2.3.	SDU-11-PXV	40
6.2.4.	SDU-12	40
6.2.5.	SDU-21	40
6.2.6.	SDU-21A	41
6.2.7.	SDU-21-PXV (in preparation)	41
6.2.8.	SDU-22	41
6.2.9.	SDU-22A	41
6.2.10.	SIO-1	41
6.2.11.	SIO-2	41
6.2.12.	SSB-x-x-x	41
6.3.	Additional information	42
6.3.1.	Cable lengths	42
6.3.2.	Derating outputs	42
7.	Connection and installation.....	43
7.1.	General notes on installation	43
7.2.	Installation / mounting	45
7.2.1.	Mounting	45
7.3.	Wiring	46
7.4.	Terminal schemes	47
7.4.1.	SCU Master	47
7.4.2.	SCU Slaves	47
7.5.	External DC 24 V – voltage supply	48
7.6.	Connection of the external encoder supply	50

7.6.1.	Incremental, HTL, SIN/COS, SSI	50
7.6.2.	Resolver	51
7.7.	Connection of digital inputs	52
7.8.	Connection of analog inputs	53
7.9.	Connection of position and speed sensors	54
7.9.1.	General information	54
7.9.2.	Assignment of encoder interface	56
7.9.2.1.	ENC 1.1 / ENC 2.1 ¹⁾	56
7.9.2.2.	ENC 1.2 / ENC 2.2 ²⁾	56
7.9.3.	Connection variants	57
7.9.3.1.	Connection of an absolute encoder as master	57
7.9.3.2.	Connection of an absolute encoder as slave	58
7.9.3.3.	Connecting an incremental encoder with TTL-Signal level	59
7.9.3.4.	Connection of a SIN/COS encoder	60
7.9.3.5.	Connection of a resolver as master	61
7.9.3.6.	Connection of a resolvers as slave	62
7.9.3.7.	Connection of proximity switch SDU-1x/-2x	63
7.9.3.8.	Connection of HTL/proximity switch SDU12/SDU22x	64
7.9.3.9.	HTL-encoder with A+/A- or B+/B- signal	64
7.9.3.10.	HTL-encoder with A+ or B+- signal	65
7.10.	Configuration of measuring distances	66
7.10.1.	Genreal description of encoder configuration	66
8.	Sensor type diagnoses	67
8.1.	Absolute encoder:	67
8.2.	Incremental encoder:	69
8.3.	SinusCosinus encoder – Standard mode	69
8.4.	SinusCosinus encoder – High resolution mode:	70
8.5.	Proxi – Switch	70
8.6.	Extended monitoring Proximity switch / proximity switch	71
8.7.	HTL – Sensor	72
8.8.	Resolver	73
9.	Reaction time	74
9.1.	Response time at standstill:	74
9.2.	Response time of FSoE in Fastchannel operation:	78
9.3.	Response times for error distance monitoring	78
10.	Safety-related characteristics	81
10.1.	Internal architecture	81
10.2.	Safety related characteristic data and wiring for the connected sensors	83
10.2.1.	Digital sensors	83
10.2.1.1.	Charakteristics of sensors / input elements	83

10.2.1.2.	DC of digital sensors / inputs	84
10.2.1.3.	Classification of digital inputs	89
10.2.1.4.	Exemplary connections of digital sensors	91
10.2.1.5.	Overview of achievable PL for digital safety inputs	96
10.2.2.	Sensors for speed and/or position detection	98
10.2.2.1.	General safety related structure of sensor interface for position and/or speed	98
10.2.2.2.	General diagnostic measures for encoder interface	99
10.2.2.3.	Encodertypen und deren Kombination, Diagnosekenndaten	100
10.2.2.4.	Specific diagnostic measures with regard to the encoder type used	103
10.2.2.5.	Safety-related switch-off threshold encoder systems for position and speed detection	104
10.2.2.6.	Safety-related evaluation of encoder systems, resolvers or their combination	107
10.2.3.	Analog sensors	109
10.2.3.1.	Exemplary connection of analog sensors	110
10.3.	Safety related characteristic data and wiring of the outputs	112
10.3.1.	Characteristic of output elements	112
10.3.2.	Diagnoses in the cut-off circuit	114
10.3.2.1.	Diagnostic functions	114
10.3.2.2.	Overview DC with respect to the chosen diagnostic functions	115
10.3.3.	Permissible capacitive and inductive load at safe outputs	116
10.3.4.	Digital outputs	117
10.3.4.1.	Characteristic data of the basic outputs	117
10.3.4.2.	Wiring examples basic outputs	119
10.3.4.3.	Wiring of a auxiliary output	126
10.3.5.	Digital outputs I/Os (IQx)	127
10.3.5.1.	Classification of the I/Os (IQx) when used as output	127
10.3.5.2.	Wiring examples for safe digital outputs I/O 's (IQx)	128
10.3.5.3.	Overview of achievable PL for digital safety outputs	133
11.	Switch types	136
12.	Commissioning and start	142
12.1.	Switch-on sequence	142
12.2.	Reset behaviour	143
12.2.1.	Types of Reset and triggering events	143
12.2.2.	Timing of Reset	144
12.2.3.	Reset functions	145
12.3.	LED displays	147
12.4.	Parametrization	148
12.5.	Regular function test	148
12.6.	Validation	148
12.6.1.	Process	149
12.6.2.	Configuration report	150
12.6.2.1.	Structure of the configuration report	150

12.6.2.2.	Creating a configuration report	150
12.6.2.3.	Filling in the configuration report	150
13.	Safety inspection	152
14.	Maintenance	153
15.	Failure and troubleshooting.....	153
16.	Replacing an assembly	153
17.	Decommissioning / disassembly / disposal.....	154
18.	Setting as EtherCAT Slave with TwinCAT3	155
18.1.	Installing the program	155
18.2.	Creating a new project / Creating a new EtherCAT network	155
18.3.	EoE settings in TwinCAT (EtherCAT settings)	164
19.	Information for design, programming, validation and test ..	166
19.1.	Risk analysis	166
19.2.	Necessary technical documents	169
19.3.	Necessary steps – design, realization and test	170
19.3.1.	Specification of the safety requirements	172
19.3.2.	Specification of the safety system	174
19.3.2.1.	Definition of the safety functions	174
19.3.3.	Software specification	176
19.3.4.	Hardware specification	176
19.3.4.1.	Selection of the SRP/CS and selection of the equipment	176
19.3.4.2.	Consideration of systematic failures	177
19.3.4.3.	Fault exclusions	178
19.3.5.	Hardware design and software design	179
19.3.5.1.	Testing of the hardware design	179
19.3.5.2.	Analysis of the circuit diagram	179
19.3.5.3.	Iterative test of the achieved safety level	180
19.3.5.4.	Verification of the software and parameters	180
19.3.5.5.	Execution of system tests / FIT (Fault Injection Test)	180
20.	List of abbreviaions	181
21.	Appendix	183
21.1.	Appendix A – EC declaration	183

1.2. Table of illustrations

Fig. 1: Rating plate SCU-2-EC/NM.....	26
Fig. 2: Network EtherCAT; standard data transfer	30
Fig. 3: Example FSoE network; safe and standard /non-safe data transfer	31
Fig. 4: structure of SCU-1-EC	33
Fig. 5: structure of SCU-2-EC/NM	33
Fig. 6: structure of SDU-11-PXV	34
Fig. 7: structure of SDU-22A	35
Fig. 8: structure of SIO-2	36
Fig. 9: structure of SSB-6-x*	37
Fig. 10: mounting of the top-hat rail	45
Fig. 11: 2-channel architecture.....	81
Fig. 12: total architecture	81
Fig. 13: Digital sensor 2-channel parallel	83
Fig. 14: Digital sensor 2-channel serial.....	83
Fig. 15: digital sensor one-channel	84
Fig. 16: Single-Channel sensor, without cross-shortening test	91
Fig. 17: Single-channel sensor with cross-shortening test	91
Fig. 18: dual-channel sensor homogenous without cycling, with positive disconnection....	93
Fig. 19: dual-channel input element heterogeneous, without cycling	93
Fig. 20 dual-channel sensor homogenous with clock.....	95
Fig. 21: dual-channel sensor system with separate signal processing	98
Fig. 22: Sensor system with single-/dual-channel partial system	98
Fig. 23 Course of fault in V-detection	104
Fig. 24: Single-channel switching P-output.....	119
Fig. 25: Single-channel switching relay output.....	119
Fig. 26: Single-channel relay output with testing	120
Fig. 27: Single-channel switching output QX00_PP with dual-channel external circuit and monitoring at output 13 as group feedback.....	121
Fig. 28: Single-channel switching output QX00_PP with dual-channel external circuit as combination of electro-mechanical element and hydraulic/pneumatic valve and monitoring at two inputs.....	122
Fig. 29: Two-channel switching relay output with external monitoring – group feedback.	123
Fig. 30: Dual-channel output with relay output and semi-conductor output – external control circuit with monitoring	124
Fig. 31: Dual-channel output with relay output – external control circuit in PL e	125
Fig. 32: Dual-channel output with semi-conductor output and external control circuit in PL e.....	125
Fig. 33 wiring of a notification output	126
Fig. 34: Two-channel output with single-channel wiring without testing	128
Fig. 35: Two-channel output with single-channel wiring with testing.....	129
Fig. 36: two-channel output in connection with a device with examined disconnection....	130
Fig. 37: two-channel output in connection with two-channel cut-off circuit with testing ..	130
Fig. 38: Redundant two-channel outputs in the same group in connection with two-channel cut-off circuit	131
Fig. 39: Redundant two-channel outputs in different groups in connection with two-channel switching-off circuit.....	132
Fig. 40: Timing of Reset	144
Fig. 41: Reset function 1	145
Fig. 42: Reset function 2	145
Fig. 43: Reset function 3	146
Fig. 44: starting TwinCAT	156
Fig. 45: TwinCAT – Geräte einfügen [TwinCAT - insert devices]	156
Fig. 46: TwinCAT - Master einfügen [TwinCAT – insert Master]	157
Fig. 47: TwinCAT – SCU einfügen [TwinCAT - insert SCU]	157
Fig. 48: TwinCAT – IO devices.....	158
Fig. 49: TwinCAT – IO devices.....	159

Fig. 50: TwinCAT – setting Slaves	159
Fig. 51: TwinCAT - linking	160
Fig. 52: TwinCAT – insert SDC.....	161
Fig. 53: TwinCAT - Task	161
Fig .54: TwinCAT connection	162
Fig. 55: TwinCAT – time parameters	163
Fig. 56: TwinCAT – RUN	163
Fig 57: TwinCAT – EoE settings	164
Fig 58: TwinCAT – IP ports	164
Fig 59: TwinCAT – pinging of the Slaves	165
Fig 60: TwinCAT + SafePLC2.....	165
Fig 61: risk analysis	166
Fig 62: risk graph according to EN 13849-1	167
Fig. 63: technical documents according to the Machine Directive	169
Fig. 64: V model.....	170
Fig. 65: safety requirements	174
Fig. 66: decision path acc. to SISTEMA.....	175
Fig. 67: Systematic failurese	177

1.3. List of tables

Table 1: reaction time	76
Table 2: calculation of response time without Overspeed	80
Table 3: calculation of response time with Overspeed.....	80
Table 4: switch types	136
Table 4: 7-segment display	143
Table 5: types of Reset.....	144
Table 6: Reset functions	145
Table 7: LED displays	147
Table 8: Phases of the V model	171
Table 9: Abbreviations.....	182

2. Basic information

2.1. Identification

Units of SCU series: **SCU-x-EC/x, SDU-x, SIO-x and SSB-x-x-x**

Firmware Version: The firmware version is indicated on the device rating plate.

Hardware Version: The hardware version is indicated on the device rating plate.



BBH Products GmbH
Böttgerstraße 40
92637 Weiden

Germany

phone: +49 961 / 4 82 44 0
fax: +49 961 / 4 82 44 33
e-Mail: info@bbh.net

2.2. Important information for use

The documentation is part of the product and contains important information on the integration of the module into devices as well as on their operation and service. The programming and parameterization of the devices are described in the programming manual. Their exact knowledge and understanding is a mandatory prerequisite for installation or modification of the device function or device parameters.

The documentation is intended for all persons involved in integration and installation planning and who perform assembly, installation, commissioning and service work on the product.

The documentation must be made available to this group of persons in a legible condition.

Make sure that the persons responsible for planning and integration, plant and operation, as well as persons who work with the modules under their own responsibility, have read and understood the documentation in full.

In case of ambiguities or further information requirements, please contact BBH Products GmbH.

2.3. Warranty claims

Compliance with the following documentation is a prerequisite for trouble-free operation and the fulfillment of any warranty claims. Therefore, read the documentation first before you start planning the integration and/or work with the connected devices from BBH Products GmbH!

Make sure that the documentation is made available in a legible condition to integration and installation planners, employees and persons who carry out assembly, installation, commissioning and service work on the product, to persons responsible for the system and its operation, and to persons who work on the devices under their own responsibility.

2.4. Liability exclusion

Observance of this documentation and the documentation on the connected devices from BBH Products GmbH is a basic prerequisite for safe operation and for achieving the specified product properties and performance characteristics. BBH Products GmbH assumes no liability for personal injury, property damage or financial loss resulting from non-observance of the documentation. Liability for material defects is excluded in such cases.

2.5. Copyright

© 2022 - BBH Products GmbH. All rights reserved.

This document is subject to German copyright law. Copying, editing, distribution, and every kind of processing outside the limits require the written consent of the respective author, or rather, of the respective creator.

2.6. Brands

The product names mentioned in this documentation are brands or registered trademarks of the respective titleholders.



EtherCAT is a technological standard for fieldbus systems.

EtherCAT® is a registered trademark and a patented technology, licensed by Beckhoff Automation GmbH, Germany, Deutschland.

2.7. Supplied documents

The following documents must be read carefully and must be considered during installation.

- Programming manual SafePLC²:
 - ➔ *HB-37480-820-01-xxF-DE programming Manual SafePLC²*
- Programming manual SCU:
 - ➔ *HB-37500-820-10-xxF-EN SCU programming manual*
 - ➔ *HB-37500-820-10-xxF-EN SCU programming manual-SARC*
- Error list SCU series:
 - ➔ *HB-37500-813-02-xxF-EN error list SCU*
 - Error list SDU devices:
 - ➔ *HB-37500-813-03-xxF-EN error list SCU- SDU-modules*
- Validation report (validation according to SafePLC² print):
 - ➔ *Print of programming software*
- Inspection report (TÜV inspection report for type release of the assemblies SCU, etc.):
 - ➔ *Inspection report SCU series.*
- Manufacturer documentation of the components integrated via the bus, and of the directly integrated components.
 - ➔ *External Documents*

xx = Placeholder for the currently valid version





Always use the latest version of the documentation and software.

In case of ambiguities or further information requirements, contact the publisher directly.

If required, you can also request the documentation in printed form from
BBH Products GmbH

2.8. Symbols and signal words

The following symbols and signal words are used in this documentation. The combination of a pictogram and a signal word classifies the respective safety note. The symbol may vary depending on the type of hazard.

	Symbol	Signal word	Description
Death		DANGER	Draws your attention to a dangerous situation that will cause <u>death or severe injury</u> if it is not avoided.
Injury + property damage		WARNING	Draws your attention to a dangerous situation that can cause death or <u>severe injury</u> if it is not avoided.
		CAUTION	Draws your attention to a dangerous situation that can cause <u>minor to moderate injury</u> , if it is not avoided.
Material damage		ATTENTION	Draws your attention to possible <u>malfunctions and material damage</u> .
No damage		NOTICE	Draws your attention to useful hints and tips that can facilitate handling and operation.
		SAFETY NOTE	Draws your attention to the use and the effects of safety information.

2.8.1. Safety information

The safety information applies not only to one specific action, but to several actions within a topic. The pictograms used indicate either a general or specific hazard.

Structure of a safety notice:

SIGNALWORD



Description of the hazard source

Type and danger of the source.

Possible consequences in case of disregard.

3. Safety

The following general safety instructions are intended to prevent personal injury and damage to property. The operator must ensure that the basic safety instructions are observed and complied with.

Make sure that the persons responsible for planning and integration, the persons responsible for the plant and its operation, as well as persons who work on the device under their own responsibility have read and understood the operating instructions completely.

In case of ambiguities or further information requirements, please contact BBH Products.

3.1. General safety information

- ➔ Never install, commission or start damaged products. Please complain immediately to transport company about any damage.
- ➔ Never open the device housing and / or never carry out modifications arbitrarily. Mortal danger due to the loss of safety functions.
- ➔ In case of improper use, incorrect installation or operation, there is a risk of serious personal injury or property damage.
- ➔ Further information can be found in the documentation.

DANGER



Working on the wiring or on the electric system can cause electric shock.

Electric shock can cause death or severe injuries due to electric current.

Therefore, work on the electric system may only be carried out by qualified persons in accordance with TRBS 1203.

(For qualified persons, knowledge of valid regulations and standards as well as of the valid accident prevention rules is presumed).

NOTICE

Work may only be carried out after the Installation manual has been read carefully and if the installation manual is strictly observed.

The device data (technical data) must be considered.

NOTICE

The content of this Installation manual is restricted to the basic function of the devices. Programming and parametrizing of the devices is described in the Programming manual. Exact knowledge and understanding of programming and parametrization is the prerequisite for the installation and the modification of both, the device function and the device parameters.

NOTICE

The devices may only be started (i. e. the start of an appropriate operation) is only permitted in compliance with the specifications of the EMC Directive.

The underlying regulations are the EMC test regulations EN 55011 and EN 61000-5-2.

NOTICE

The valid VDE regulations and other special safety regulations must be observed.

NOTICE

The configured monitoring functions, as well as their parameters and their links must be proved by a validation report.

WARNING

Inputs and outputs for standard functions, as well as digital data and analogue data transmitted by communication units must not be used for safety-related applications. Data errors can cause failures that can also provoke unexpected start-up of the whole plant.

3.2. Target group

The persons involved in the planning for the integration of the assembly in devices as well as for their use in applications must have sufficient qualifications. This usually consists of a university or technical education for electrical / electronic systems in combination with special knowledge of the laws, regulations, standards and guidelines for the protection of persons and property when dealing with machines and plants.

All installation, commissioning, troubleshooting and maintenance work must be carried out **by a qualified electrician** (IEC 60364 or CENELEC HD 384 or DIN VDE 0100 and IEC 60664 or DIN VDE 0110 and observe national accident prevention regulations).

Qualified electricians in the sense of these basic safety instructions are persons who are acquainted They must also be conversant with the applicable safety regulations and laws, in particular the requirements of EN ISO 13849-1 and the other standards, directives and laws mentioned in this documentation.

The aforementioned persons must have the authorization explicitly granted by the company to commission, program, parameterize, label and ground devices, systems and circuits in accordance with the standards of safety technology.

All work in the other areas of transport, storage, operation and disposal must be carried out by persons who have been suitably instructed.

The following table explains the competencies of the target groups in detail:

Target group	Requirement and knowledge
project developer	<p>Basic technical education (technical college, engineering education or equivalent work experience).</p> <p>Knowledge of:</p> <ul style="list-style-type: none"> ▪ the operation of a PLC, ▪ safety regulations, ▪ the application, ▪ Project planning and validation of safety controls, ▪ Project planning of EMC-compliant system structures
Electrician	<p>Specialized electrical training (in accordance with industry training guidelines).</p> <p>Knowledge of:</p> <ul style="list-style-type: none"> ▪ Safety regulations, ▪ wiring guidelines, ▪ circuit diagrams, ▪ professional making of electrical connections
Commissioning engineer	<p>Basic technical education (university of applied sciences, engineering education or corresponding professional experience).</p> <p>knowledge of:</p> <ul style="list-style-type: none"> ▪ safety regulations, ▪ the operation of the machine or system, ▪ basic functions of the application, ▪ system analysis and troubleshooting, ▪ the adjustment possibilities on the operating devices. ▪ Validation of safety controls
Service technician	<p>Basic technical education (university of applied sciences, engineering education or corresponding professional experience).</p> <p>Knowledge of:</p> <ul style="list-style-type: none"> ▪ the operation of a PLC, ▪ safety regulations, ▪ the operation of the machine or plant, ▪ diagnostic possibilities, ▪ systematic error analysis and elimination

3.3. Terms

The SCU assemblies manufactured by BBH Products GmbH serve to implement safety-relevant functions by safe communication via FSoE and non-safe communication by means of EtherCAT. These are always having a two-channel design: system A and system B.

- The term "**safe**" is used in accordance with the following standards: DIN EN ISO 13849-1, DIN EN 61508-1:2011-02 (cf, the chapter "Relevant standards").
- The term "**Safe function for applications up to PL e or SIL 3**" indicates functions in line with the above standards with appropriate integrity (reliability).
- The term "**non-safe**" refers to functions and data interfaces that do not or not completely fulfill the requirements according to the aforementioned standards. The system software "**SafePLC²**" serves for programming and configuration of the SCU-assemblies manufactured by BBHProducts GmbH.
- In this document, the abbreviation "**SCU**" refers to the FSoE Master assemblies SCU-0-EC/x, SCU-1- EC/x and SCU-2-EC/x.
- The abbreviations **SDU**, **SIO** and **SSB** refer to the FSoE slave assemblies of the SCU series.
- The **-S variants** of the assemblies are identical to the standard devices

3.4. Relevant standards and directives

The following standards have been considered for development and implementation of the product. The development and implementation of the product takes into account:

- DIN EN ISO 13849-1:2015 Sicherheit von Maschinen – Sicherheitsbezogene Teile von Steuerungen
- IEC 61508-1:2011-02 Funktionale Sicherheit sicherheitsbezogener elektrischer / elektronischer/programmierbarer elektronischer Systeme
- DIN EN ISO 13850:2016-05 Sicherheit von Maschinen - Not-Halt - Gestaltungsleitsätze
- DIN EN 60529:2014-09 – Schutzarten durch Gehäuse
- DIN EN 62061:2016-05 – Sicherheit von Maschinen - Funktionale Sicherheit sicherheitsbezogener elektrischer, elektronischer und programmierbarer elektronischer Steuerungssysteme
- DIN EN 60204-1:2014-10 – Sicherheit von Maschinen - Elektrische Ausrüstung von Maschinen - Teil 1: Allgemeine Anforderungen
- DIN EN 60204-32:2009-03 – Sicherheit von Maschinen - Elektrische Ausrüstung von Maschinen - Teil 32: Anforderungen für Hebezeuge
- DIN EN 61800-5-2:2014-06 – Elektrische Leistungsantriebssysteme mit einstellbarer Drehzahl - Teil 5-2: Anforderungen an die Sicherheit - Funktionale Sicherheit
- DIN EN 574:2008-12 – Sicherheit von Maschinen - Zweihandschaltungen - Funktionelle Aspekte – Gestaltungsleitsätze
- DIN EN 55011:2014-11 – Industrielle, wissenschaftliche und medizinische Geräte - Funkstörungen - Grenzwerte und Messverfahren
- DIN EN 61000-6-2:2016-05 – Elektromagnetische Verträglichkeit (EMV) - Teil 6-2: Fachgrundnormen - Störfestigkeit für Industriebereiche
- DIN EN 60068-2-6:2008-10 – Umgebungseinflüsse - Teil 2-6: Prüfverfahren - Prüfung Fc: Schwingen (sinusförmig)
- DIN EN 60068-5-2:2000-08 – Umweltprüfungen - Teil 5: Leitfaden für das Festlegen von Prüfverfahren
- DIN EN ISO 12100:2013-08 – Sicherheit von Maschinen – Allgemeine Gestaltungsleitsätze – Risikobeurteilung und Risikominderung
- DIN ISO/TR 14121-2 – Sicherheit von Maschinen – Risikobeurteilung – Teil 2: Praktischer Leitfaden und Verfahrensbeispiele

The following directives have been considered for development and implementation of the product:

- 2006/42/EG (Machinery Directive)
- 2014/35/EU (Low-Voltage Directive)
- 2014/30/EU (EMC Directive)
- 2011/65/EU (RoHS Directive)

3.5. Intended use

The modules of the **SCU series** are programmable safety controllers for the production of safety functions, safe monitoring and switch-off of drives. The devices are intended for decentralized use in a network:

- in Emergency Stop devices,
- as safety related components according to Machine Directive 2006/42/EG,
- as PES for zur risk reduction according to IEC 61508,
- in safety circuits EN 60204-1 u. EN 60204-32,
- as PES for functional safety according to IEC 62061,
- as SRP/CS according to EN ISO 13849,
- as device for the manufacturing of security devices according to EN 61800-5-2,
- as logic units for signal conversion and for signal processing in two hand controls according to EN 574.

- ➔ The **SCU series** may only be used for the applications specified in the technical description and in compliance with the described general technical conditions.
- ➔ The **SCU series** may only be operated in conjunction with recommended or approved third-party devices.
- ➔ The **SCU series** has been developed, manufactured, tested and documented in compliance with the relevant directives and standards. Therefore, if the described instructions and safety-related notes are observed, the product does not normally present any hazards with regard to damage to property or to the health of persons.



The SCU assemblies are safety-related components in accordance with appendix IV of the EU directive 2006/42/EG (Machine Directive). They have been developed, engineered and manufactured in accordance with the above directive and the EC directive 2014/30/EU (EMC Directive) – cf. EC Declaration of Conformity in the appendix.

NOTICE

SCU modules without an UL approval / a CSA approval can be used in the USA and Canada if the following conditions are observed:

- ➔ The switch voltage of the output relays must be limited to max. 24 V.
- ➔ For power supply of the SCU assemblies and of their inputs and their outputs, a power pack must be used. The power pack used must comply with the CLASS 2 requirements according to UL 1310.

Under these conditions, an UL approval / a CSA approval are not necessary, and the SCU assembly can in be used in switching systems according to UL 508A

WARNING**Proper use of the devices**

The use of the above devices contrary to regulations and conditions indicated here can cause death or injury of persons as well as damage to connected devices and connected machinery.

CAUTION**Machinery Directive**

The Machinery Directive 2006/42/EC and the EMC Directive 2014/30/EU must be observed during integration and operation!

NOTICE**Warranty**

The use of the above devices also results in the loss of any type of warranty claim and of any type of damage claims.

The technical data and the information on connection conditions can be found on the rating plate and in this documentation and must be observed.

3.6. Storage and transport

The assemblies are stored and dispatched in protected boxes. The boxes protect the assemblies against falling and impact.

The information concerning transport, storage and appropriate handling must be observed.

The climatic conditions indicated in the chapter "Technical specifications of the SCU series" must be observed.

NOTICE

For storage and transport, the conditions according to EN 60068-2-6 must be observed with respect to the values indicated under "Technical specifications of the SCU series".

3.7. Placement

The placement and cooling of the equipment must be selected to ensure ambient and operating conditions in accordance with the following limits and data.

The devices must be protected against any impermissible stress. In particular, no components may be bent and/or insulation distances changed during transport and handling. Touching electronic components and contacts must be avoided.

The safety controllers contain electrostatically sensitive components that can easily be damaged by improper handling. Electrical components must not be mechanically damaged or destroyed (health hazard under certain circumstances!).

WARNING**Intended use**

➔ The following areas of application are expressly excluded for the control module:

- Use in areas subject to explosion or fire hazards
- Use in mining
- Use outdoors
- Use in damp rooms or rooms with splash water hazard
- use in environments with highly polluted air
- use in environments with harmful oils, acids, gases, vapors, dusts, radiation, etc.
- the use in non-stationary applications as far as the mechanical limit values can be exceeded.

Other products must be used for these applications!

➔ The EN ISO 13849-1 standard and other functional safety standards have been taken into account in the engineering of the SCU series assemblies.

CAUTION**Destruction of the assembly or the control system in case of improper handling!**

The assemblies may only be installed and removed with the supply voltage switched off. Otherwise, the assemblies may be destroyed or undefined signal states may cause damage to the control system.

NOTICE

It is requested that all potentially dangerous incidents related to BBH safety technology be reported immediately to BBH. Furthermore, it is requested that safe products that have failed due to a defect and are considered beyond repair be sent to BBH for analysis.

Liability and warranty of the manufacturer are excluded, if the damages are due to one or more of these causes:

- Improper use of the unit
- Non-observance of standards and guidelines
- Improper starting, operation, maintenance, servicing, and mounting of the unit and of their connections.
- Disregard of the safety information given in this manual
- Unauthorized modifications, design changes or arbitrary technical changes
- Use of unauthorized spare parts and accessory components
- Catastrophes due to external impact and higher force.

3.8. Electrical connection

The applicable national accident prevention regulations (e.g. BGV A3) must be observed when working on live equipment.

The electrical installation must be carried out in accordance with the relevant regulations (e.g. cable cross-sections, fuses, protective conductor connection). Further instructions are contained in the documentation.

Instructions for EMC-compliant installation - such as shielding, grounding, arrangement of filters and routing of cables - can be found in the documentation of the safety module. Compliance with the limit values required by EMC legislation is the responsibility of the manufacturer of the system or machine.

Protective measures and protective devices must comply with the valid regulations (e.g. EN 60204-1).

WARNING**Danger to persons due to electric shock!**

- Supply the device exclusively from voltage sources which have protective extra-low voltage (e.g. SELV or PELV according to EN 61131-2).
- If a SELV voltage source is used, it can become PELV due to the design of the module and the connections (earth fault!).
- Protective extra-low voltage circuits must always be safely isolated from circuits with dangerous voltage.

CAUTION**Fire hazard in case of component failure**

Provide adequate fuse protection for the 24 V DC power supply of the control system in the end application! (Information on this can be found in the Power supply section).

3.9. Behaviour in case of emergencies

The SCU units have been developed and built to be able to autonomously recognize failures by means of diagnostics and to autonomously change into the safe status (cf. chapter "Safe status").

CAUTION

To eliminate wiring errors, the affected block must be de-energized, because short circuits or incorrect tensions can cause failures in the block

DANGER

Working on the wiring or on the electric system can cause electric shock. Electric shock can cause death or severe injuries due to electric current. Therefore, work on the electric system may only be carried out by persons who are qualified persons according to TRBS 1203.

3.10. Safe status

The safe status of the SCU unit is:

- All outputs of the group are safely switched off, and the unit is in the error status. The error status remains until its cause has been eliminated and the current error status has been confirmed.
- The status of the unit is permanently shown on the 7-segment display, if the 7-segment display is supplied with voltage.
- Errors are sequentially displayed by a letter and 4 numbers (cf. Troubleshooting).

3.11. Scope of delivery SCU

The assemblies of the SCU series are delivered with the input connectors, the output connectors and the power supply connectors.

The assemblies are enclosed in the product information of the SCU series. Among others, the product information includes the link to download the complete documentation.

INFORMATION The documentation (installation manual, programming manual) are free available via online download.

INFORMATION Programming software, dongle (Hard Lock), programming cable, etc. must ordered separately.

3.12. Labelling / rating plate SCU

The rating plate is mounted on the left sidewall of the assembly, and contains the following information:

- Type = Type designation
- Product No.: = Product number
- Serial No.: = Serial number
- HW-Release: = Hardware Release marking
- SW-Release: = Software Release marking
- NORM: = Safety category
- Power = Properties of the voltage supply
- Input: = Properties of the inputs
- Output: = Properties of the outputs
- Date: = Manufacture date (week number / year)



Fig. 1: Rating plate SCU-2-EC/NM

3.12.1. Rating plate SSB-x-x-x

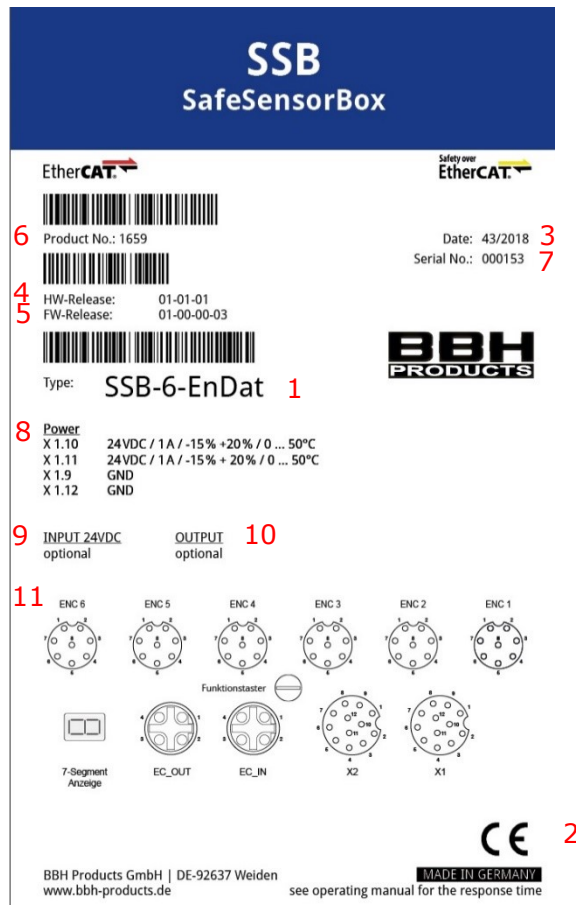

The rating plate SSB-x-x-x contains the following information:

- (1) Type : Type designation
- (2) CE Mark of conformity
- (3) Date: Manufacture date (week number / year)
- (4) HW-Release: Hardware Version
- (5) FW-Release: Firmware Version
- (6) Product No.: Product number decimal with barcode
- (7) Serial No.: Serial number decimal
- (8) Power: Properties of power supply
- (9) INPUT: Properties of the inputs
- (10) OUTPUT: Properties of the outputs
- (11) Pin assignment

4. Use

4.1. Device description

4.1.1. Function

SCU-x-EC (in short: SCU) are master units for FSoE communication. SCU-1-EC and SCU-2-EC serve to read encoder data and switching states from FSoE Slave units (e. g. SSB, SIO, SDU) and from external FSoE devices to implement safety functions.

To implement safety functions, the SCU (FSoE Master) can send, receive and process safe data via FSoE and non-safe data via EtherCAT for this purpose. In the transfer layer of the EtherCAT network, the SCU only functions as Slave and sends data to or receives data from the EtherCAT Master. The FSoE Slaves (e. g. SSB, SIO, SDU) send and receive the data of the axles to be monitored and of the axles' digital inputs and digital outputs in the same way to / from the EtherCAT Master. During the sending process and during the receiving process, the FSoE data (safe) are transmitted in closed data containers. The EtherCAT Master summarizes the FSoE data received by the Slaves, and transfers them to the SCU (FSoE Master). In the opposite data direction, the EtherCAT Master receives the overall data framework of the FSoE data containers from the SCU, and distributes the FSoE data containers to the different Slaves.

The -S variants of the assemblies are identical to the standard devices.

NOTICE The EtherCAT Master transfers the FSoE data containers unmodified from the FSoE-Slaves to the FSoE-Master and vice versa. Thus, the EtherCAT-Master is only responsible for the correct data transfer. For data transfer, the EtherCAT Master needs all connection information necessary to establish this cross-communication. The information necessary to establish this cross-communication must be provided by the configuration tool of the EtherCAT Master.

The following safety functions are available in the SCU:

- Safe processing of input signals and of output signals
- Speed monitoring
- Rpm monitoring
- Standstill monitoring
- Direction monitoring
- Safe increment
- Emergency stop monitoring
- Position monitoring
- Position range monitoring
- Multiaxes Position Monitoring
- Monitoring of the history area
- Target Position Monitoring
- Safe Arithmetic Calculation

4.1.2. Embedding into the EtherCAT network and into FSoE

4.1.2.1. FSoE data transfer

FSoE (Fail Safe over EtherCAT) is the safe data transfer via the EtherCAT network. The application data are bundled into data packages and are additionally supplemented with unique identifications and unique checksums. Additionally, FSoE is monitored via timer (Watchdog). For each participant, these timers are checked in the network. Thus, an interruption of FSoE can be safely recognized. The checksum is calculated by means of a CRC16 (16-bit-Cycle-Redundancy-Check) and permits to recognize errors with a residual error probability of $< 10^{-9}$. Thus, FSoE permits safe data transfer up to PL e or SIL 3.

Data package and CRC are transferred together (as one package) via the non-safe EtherCAT network. – Due to the additional calculation effort, the transfer of data package and CRC takes place every 1ms.

4.1.2.2. EtherCAT network

The EtherCAT network consists of one Master and of a determined number of Slaves. Data transfer takes place via Ethernet connections between the EtherCAT Master and every participant. As a rule, these Ethernet connections are serial connections from participant to participant. Via these Ethernet connections, Ethernet Frames are sent. First, every network participant must read the received data. Then, it must filter out the data addressed to it and insert the output data into the Frame. After the Frame has passed all Slaves, it is sent back to the EtherCAT Master.

As thus every participant has influence on the transfer of a message, the network must be exactly defined, or rather, it must be specified. This specification takes place via the ESI data. The ESI data determine the participants and their properties.

Data transfer is always initiated by the Master. – Data transfer takes place in the EtherCAT network with an optimum transfer time of some μs .

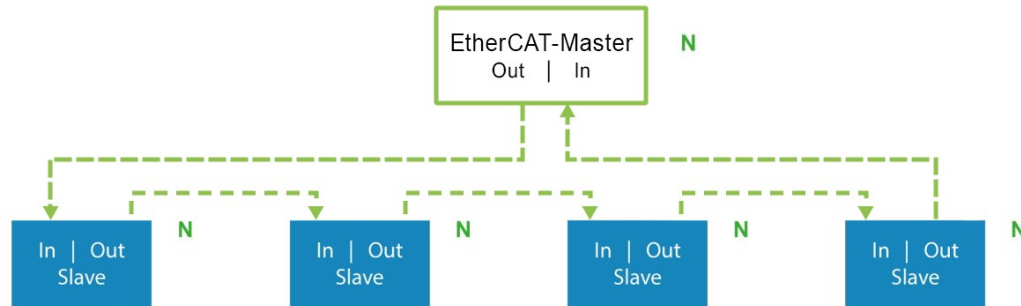

N= non-safe (Data Transfer) = EtherCAT

Fig. 2: Network EtherCAT; standard data transfer

4.1.2.3. EtherCAT data transfer

Basically, a difference is made between process data that must be transferred cyclically, and acyclic data, e. g. configuration data and diagnostics data.

The cyclical process data are assigned to the PDOs (Process Data Objects). Length and content of the PDOs can be either fixed or variable. The variable content is fixed by PDO mapping. The possibilities of the PDO are fixed by the individual participant description file (ESI file).

Primarily, acyclical data services are SDOs (Service Data Objects), but they can also be EoE (Ethernet over EtherCAT) or FoE (File over EtherCAT). Also here, the possibilities of the acyclic services are fixed by the individual participant description file (ESI file).

4.1.2.4. FSoE and EtherCAT

The Ethernet frame of the EtherCAT network can contain safe data as well as standard data. The safe data are called FSoE data and are assigned to the protocol stack of the FSoE Master and the FSoE Slave. FSoE data are transferred cyclically. Thus, they are contained in the PDO of the respective participant.

The SCU is designed as FSoE Master and starts the safe data transfer via FSoE. Additionally, as EtherCAT Slave, the SCU is participant in the standard EtherCAT network.

A separate Ether CAT Master starts the standard data transfer via EtherCAT.

The PDOs with the included FSoE data are transferred cyclically. The cycle time of the data transfer is determined in the configuration of the EtherCAT Master. As a rule, the cycle time of the data transfer should be set many times shorter than the cycle time of the FSoE

Master. Thus, the data update within the Watchdog monitoring time of the Master can be guaranteed.

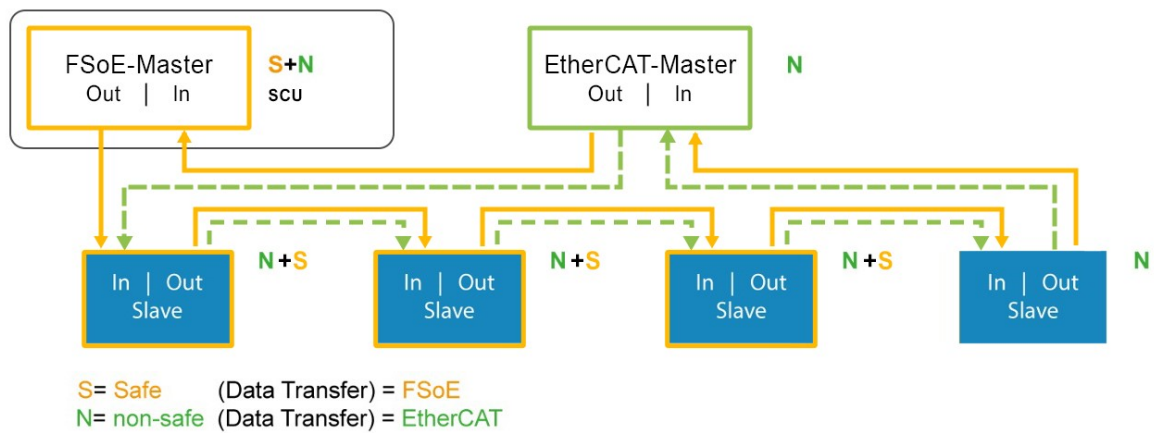

Fig. 3: Example FSoE network; safe and standard /non-safe data transfer

Among others, the following assemblies are suitable as FSoE:

- SIO = Safe IO Slave assembly by BBH to import IOs
- SDU = Safe Drive Unit Slave assembly by BBH to import one axis
- SSB = Safe Sensor Box Slave assembly by BBH to import 6 axes

Generally, also assemblies by other manufacturers can be integrated, if they offer an FSoE communication.

4.1.3. The principle of safe monitoring with SCU

The SCU master assembly receives the data of inputs and axles from the Slave assemblies (e. g. SIO, SDU, SSB by BBH Products or FSoE slaves by other manufacturer) and analyzes the received data.

After data analysis, the SCU can implement safety functions, and switch outputs accordingly. – This can either happen directly via the outputs of the assemblies or via the outputs of the Slave assemblies.

As the data transfer via EtherCAT happens more frequently (e. g. every 62.5 μ s), data can at first be transferred in the non-safe way. Afterwards, they can be transmitted less frequently (every 1 ms). Instead, they can be transferred and used in a safe way. This can be necessary to optimize response times.

4.2. Operation and service

The SCU assembly is designed for to be used in a protected environment (switch cabinet (cf. Technical specifications of the SCU series).

Before mounting the assembly and before removing the assembly, or before separating signal lines, the assembly must be de-energized. To de-energize the assembly, all live feed lines to the device must be disconnected and checked for absence of voltage.

While the assembly is mounted, and while the assembly is removed, appropriate measures must be taken to avoid electrostatic discharge to the terminals and to the plug connections led to the outside. To avoid electrostatic discharge to the terminals and to the plug connections led to the outside, contact with the terminals should be restricted to a minimum, and before and after the contact, grounding (e. g. by a grounding bracelet) should take place.

5. General structure of the series

The series SCU consists of:

- FSoE Master (SCU)
- FSoE Slaves (SDU, SIO, SSB)

The -S variants of the assemblies are identical to the standard devices

5.1. FSoE Master (SCU)

In general, the SCU assemblies (SCU-0-EC/x, SCU-1-EC/x and SCU-2-EC/x) are structured as follows:

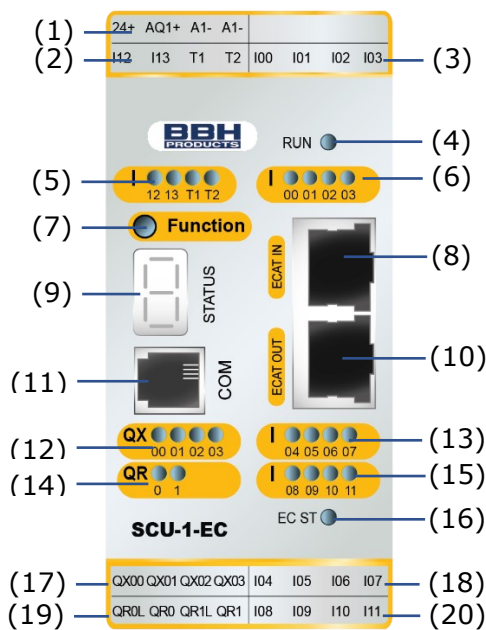

Fig 4: structure of SCU-1-EC

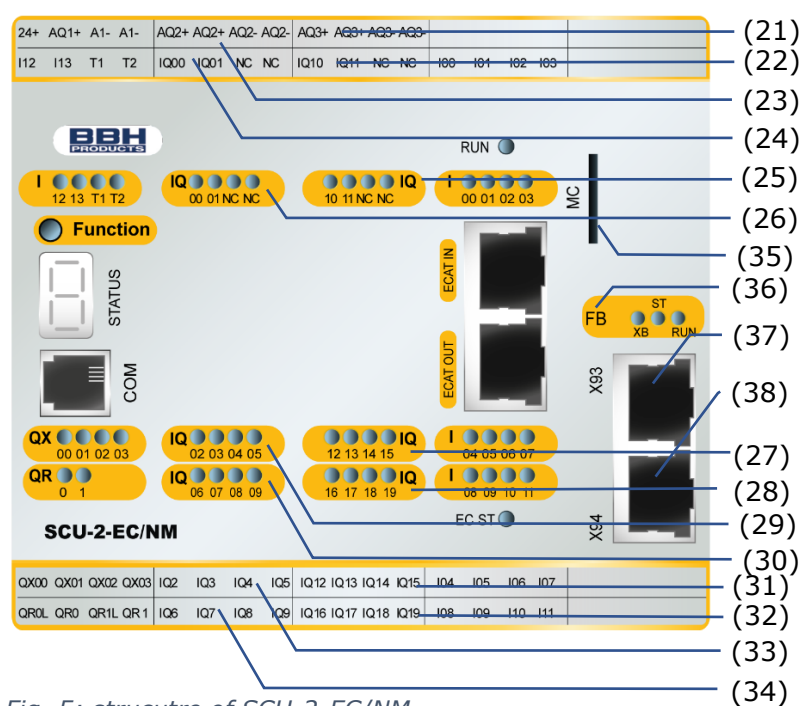

Fig. 5: structure of SCU-2-EC/NM

- (1) Connection terminal voltage supply
- (2) Connection terminal inputs, clock outputs
- (3) Connection terminal inputs
- (4) STATUS-LED display system status
- (5) LED display status inputs, clock outputs
- (6) LED display status inputs
- (7) Reset-button for displaying CRC
- (8) Connection socket EtherCAT cable (IN)
- (9) 7 segment display – system status
- (10) Connection socket EtherCAT cable (OUT)
- (11) Connection socket Service interface
- (12) LED display status outputs
- (13) LED display status inputs
- (14) LED display status outputs
- (15) LED display status inputs
- (16) LED display EtherCAT-connection
- (17) Connection terminal outputs

- (18) Connection terminal inputs
- (19) Connection terminal outputs
- (20) Connection terminal inputs
- ONLY SCU-2-EC:**
- (21) Connection terminal voltage supply
- (22) Connection terminal IOs, outputs
- (23) Connection terminal voltage supply
- (24) Connection terminal IOs,
- (25) LED display status IOs
- (26) LED display status IOs
- (27) LED display status IOs
- (28) LED display status IOs
- (29) LED display status IOs
- (30) LED display status IOs
- (31) Connection terminal IOs
- (32) Connection terminal IOs
- (33) Connection terminal IOs
- (34) Connection terminal IOs

ONLY /NM-variants:

(35) Memory card slot

(36) LED display status fieldbus interface

(37) Connection socket fieldbus

(38) Connection socket fieldbus

5.2. FSoE-Slaves (SDU, SIO, SSB)**5.2.1. SDU-x**

Fig. 6: structure of SDU-11-PXV

- | | |
|--|---|
| (1) Connection terminal
Voltage supply | (11) 7 segment display
– system status |
| (2) Connection terminal inputs,
clock outputs | (12) STATUS-LED display
fieldbus interface |
| (3) Connection terminal
auxiliary outputs | (13) Service interface connection socket |
| (4) Connection terminal
voltage supply sensor | (14) Connection socket fieldbus |
| (5) Connection terminal inputs | (15) Connection Encoder interface |
| (6) STATUS-LED display system status | (16) LED display status outputs |
| (7) LED- display status inputs,
clock outputs | (17) LED display status outputs |
| (8) LED display status inputs | (18) Connection socket fieldbus |
| (9) Memory card slot | (19) LED display status inputs |
| (10) Reset button for displaying the CRC | (20) LED display status inputs |
| | (21) Connection terminal outputs |
| | (22) Connection terminal outputs |
| | (23) Connection terminal inputs |
| | (24) Connection terminal inputs |

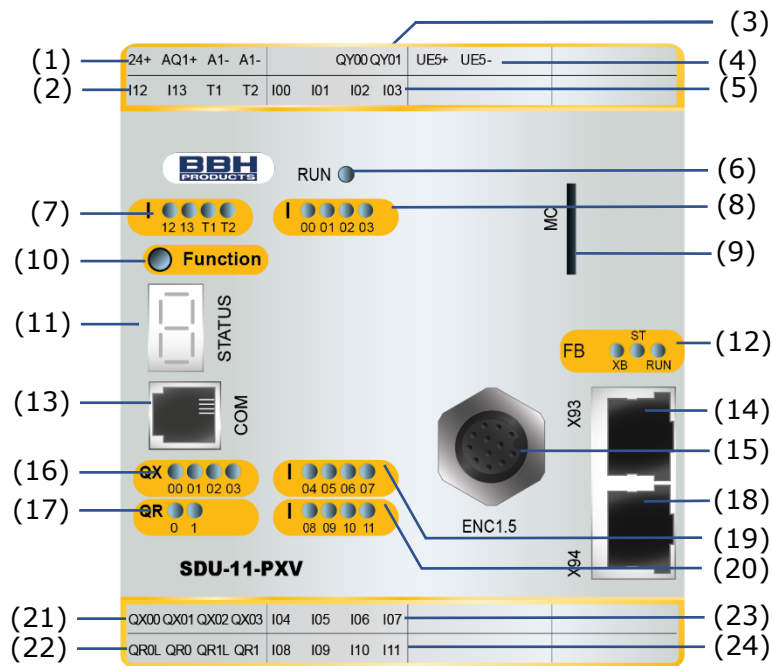
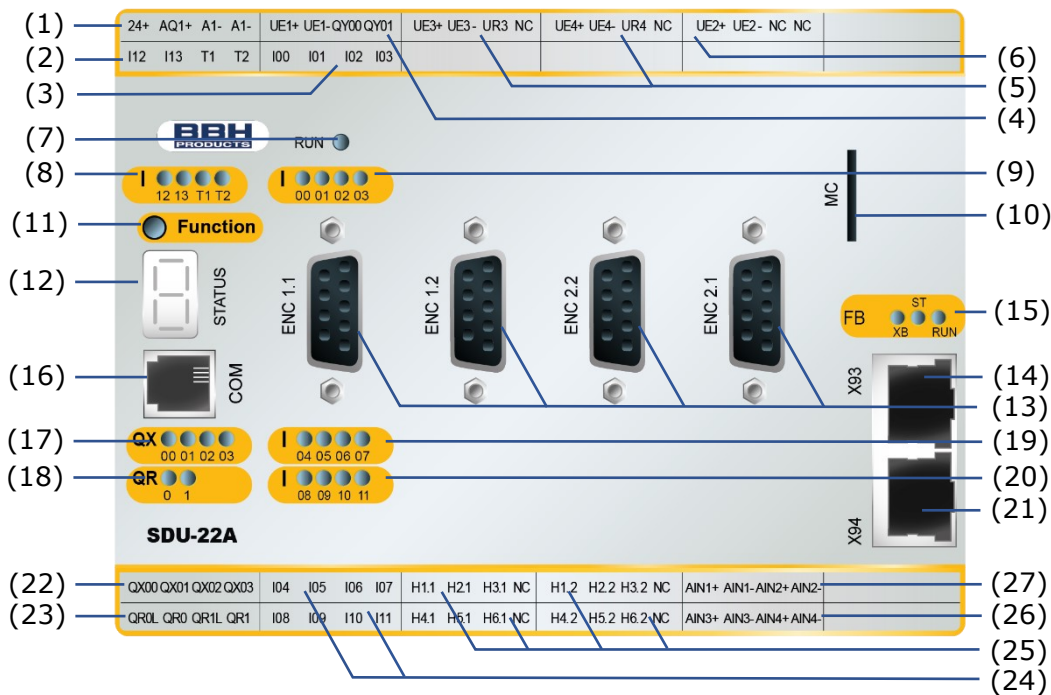

Fig. 7: structure of SDU-22A

- | | |
|---|---|
| (1) Connection terminal voltage supply | (16) Connection socket service interface |
| (2) Connection terminal inputs, clock outputs | (17) LED display status outputs |
| (3) Connection terminal inputs | (18) LED display status outputs |
| (4) Connection terminal voltage supply encoder, auxiliary outputs | (19) LED display status inputs |
| (5) Connection terminal voltage supply encoder | (20) LED display status inputs |
| (6) Connection terminal voltage supply encoder | (21) Connection socket fieldbus |
| (7) LED display system status | (22) Connection terminal outputs |
| (8) LED display status inputs, clock outputs | (23) Connection terminal outputs |
| (9) LED display status inputs | (24) Connection terminal inputs |
| (10) Memory card slot | (25) Connection terminal Encoder |
| (11) Reset-button for displaying CRC | (26) Connection terminal analog inputs (current inputs) |
| (12) 7 segment display – system status | (27) Connection terminal analog inputs (voltage inputs) |
| (13) 4 encoder interface connections | |
| (14) Connection socket fieldbus | |
| (15) LED display status fieldbus interface | |

5.2.2. SIO-x

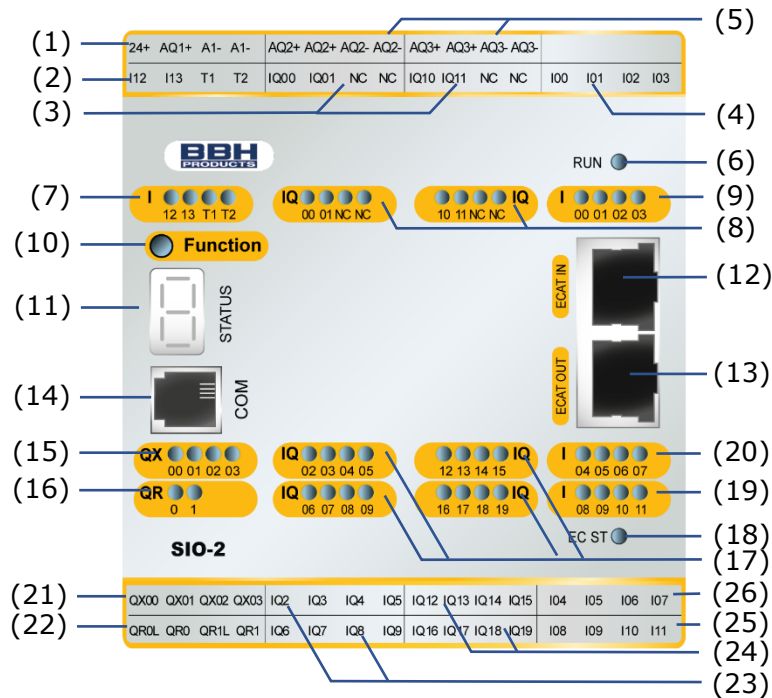

Fig. 8: structure of SIO-2

- | | |
|---|---|
| (1) Connection terminal voltage supply | (14) Connection socket service interface |
| (2) Connection terminal inputs, clock outputs | (15) LED display status outputs |
| (3) Connection terminal IOs | (16) LED display status outputs |
| (4) Connection terminal inputs | (17) LED display status IOs |
| (5) Connection terminal voltage supply | (18) LED display status EtherCAT-connection |
| (6) LED display system status | (19) LED display status inputs |
| (7) LED display status inputs, clock outputs | (20) LED display status inputs |
| (8) LED display status IOs | (21) Connection terminal outputs |
| (9) LED display status inputs | (22) Connection terminal outputs |
| (10) Reset-button for displaying CRC | (23) Connection terminal IOs |
| (11) 7 segment display – system status | (24) Connection terminal IOs |
| (12) Connection socket EtherCAT cable (IN) | (25) Connection terminal inputs |
| (13) Connection socket EtherCAT cable (OUT) | (26) Connection terminal inputs |

5.2.3. SSB-x-x-x

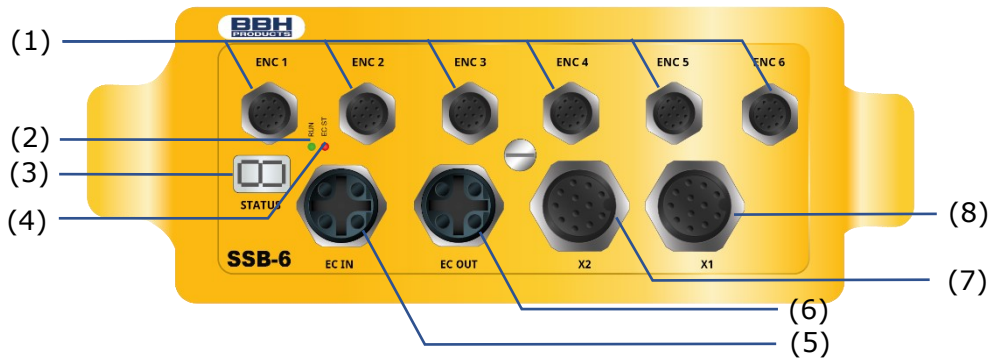

Fig. 9: structure of SSB-6-x*

- | | |
|--|---|
| (1) Connection encoder interfaces | (7) Connection socket outputs (optional) |
| (2) STATUS-LED display system status | (8) Connection socket voltage supply, inputs (optional) |
| (3) 7 segment display – system status | |
| (4) LED display status EtherCAT-connection | |
| (5) Connection socket EtherCAT-cable (IN) | |
| (6) Connection socket EtherCAT-cable (OUT) | |

* available in: EnDat 2.2 and Hyperface DSL with or without I/O 's
(SinCos in preparation)

5.3. Encoder specifications

Incremental-TTL		
	Physical Layer	RS-422 compatible
	Measuring signal A/B	Track with 90 degree phase difference
	Max. frequency of input cycles (ENC 1.1, ENC 2.1 / ENC 1.2, ENC 2.2)	200 kHz / 250 kHz
	Type of connection	D-SUB 9pol
Sin / Cos		
	Physical Layer	RS-422 compatible
	Measuring signal A/B	Track with 90 degree phase difference
	Standard mode	
	Max. frequency of input cycles (ENC 1.1, ENC 2.1 / ENC 1.2, ENC 2.2)	200 kHz / 250 kHz
	High resolution mode	
	Max. frequency of input cycles (ENC 1.2. / ENC 2.2)	15 kHz
	Type of connection	D-SUB 9-polig
SSI-Absolut		
	Data interface	Serial Synchronous Interface (SSI) (SSI) with variable data length of 12 – 28 Bit
	Data format	Binary, Graycode
	Physical Layer	RS-422 compatible
	SSI-Master operation	
	Taktrate	150 kHz
	SSI-Listener operation (Slave mode)	
	Clock rate (ENC 1.1, ENC 2.1 / ENC 1.2, ENC 2.2)	250 kHz / 350 kHz
	Min. clock pause time	150 µsec
	Max. clock pause time	1 msec
	Type of connection	D-SUB 9pole
Resolver		
	Measuring signal	Sin/Cos – track with 90 degree phase difference
	Signal frequency	max. 600 Hz (900Hz Deep pass)
	Input voltage	max. 8 Vss (at 4,7 kΩ)
	Resolution:	9 Bit / pole
	Supported pole number	2 - 16
	Resolver- Listener-mode	
	Reference frequency (Listener)	4 kHz – 16 kHz
	Reference amplitude	8 Vss – 28 Vss
	Reference signal form	Sinusoidal, triangle, rectangle
	Transformation ratio	2:1; 3:2; 4:1
	Phase fault	max. 8°
	Type of connection (ENC 1.2, ENC 2.2)	D-SUB 9pole
Incremental-HTL		
	Signal level	24V / 0V
	Physical Layer	PUSH / PULL
	Max. counting pulse frequency	200 kHz
	Type of connection (x27, x28, x29, x30)	Plug-in terminals with spring or screw connection

Proxi (HTL proximity sensor)		
	Signal level	24V / 0V
	Max. counting pulse frequency (switching logic debounced)	10 kHz
	Pulse width	50 µsec
	Type of connection (X23)	Plug-in terminals with spring or screw connection
Proxi – extended monitoring		
	Signal level	24V / 0V
	Max. counting pulse frequency (switching logic debounced)	4 kHz
	Physical Layer	PUSH / PULL
	Measuring signal A/B	Track with 90 degree phase difference
	Type of connection (X23)	Plug-in terminals with spring or screw connection

6. Technical specifications of the SCU series

6.1. SCU Master

6.1.1. SCU-0-EC/x

- [Specification sheet](#)
- [General technical data](#)
- [Dimensions: SCU-0-EC , SCU-0-EC/NM](#)

6.1.2. SCU-1-EC/x

- [Specification sheet](#)
- [General technical data](#)
- [Dimensions: SCU-1-EC , SCU-1-EC/NM](#)

6.1.3. SCU-2-EC/x

- [Specification sheet](#)
- [General technical data](#)
- [Dimensions: SCU-2-EC, SCU-2-EC/NM](#)

6.2. SCU Slaves

6.2.1. SDU-11

- [Specification sheet](#)
- [General technical data](#)
- [Dimensions](#)

6.2.2. SDU-11/NM

- [Specification sheet](#)
- [General technical specifications](#)
- [Dimensions](#)

6.2.3. SDU-11-PXV

- [Specification sheet](#)
- [General technical specifications](#)
- [Dimensions](#)

6.2.4. SDU-12

- [Specification sheet](#)
- [General technical specifications](#)
- [Dimensions](#)

6.2.5. SDU-21

- [Specification sheet](#)
- [General technical specifications](#)
- [Dimensions](#)

6.2.6. SDU-21A

- [Specification sheet](#)
- [General technical specifications](#)
- [Dimensions](#)

6.2.7. SDU-21-PXV (in preparation)

- Specification sheet
- General technical specifications
- Dimensions

6.2.8. SDU-22

- [Specification sheet](#)
- [General technical specifications](#)
- [Dimensions](#)

6.2.9. SDU-22A

- [Specification sheet](#)
- [General technical specifications](#)
- [Dimensions](#)

6.2.10. SIO-1

- [Specification sheet](#)
- [General technical specifications](#)
- [Dimensions](#)

6.2.11. SIO-2

- [Specification sheet](#)
- [General technical specifications](#)
- [Dimensions](#)

6.2.12. SSB-x-x-x

- [Specification sheet](#)
- [General technical specifications](#)

6.3. Additional information

6.3.1. Cable lengths

EtherCAT IN	< 100m
EtherCAT OUT	< 100m
Digital inputs (type 1)	< 30m *) < 100m **)
Digital outputs (type1, type2, message, pulses [clock])	< 30m
Relay outputs	< 30m

Note

*) : Use of shielded cables. Unshielded cables can be used under the following restrictions:

- Not to be laid within switch cabinets
 - No parallel cable routing. Cables must be laid far from interference sources (motor cables, power wires, engine brakes etc.
- How to be laid outside the switch cabinet
 - Electric wires separated by separators in metal cable ducts
 - Cable arrangement in metallic conduit
 - Cable arrangement separated from power wires with a distance of > 10cm, crossing in 90° angles

**): Exclusive use of shielded cables with the additional measures mentioned above

6.3.2. Derating outputs

Maximum current load based on temperature.

This derating should be considered for all 2A outputs (IO-Board and REL-Board)!

2A outputs can be fully loaded at an ambient temperature of **up to 30°C**.

From a ambient temperature from **30°C** to maximum **50°C**, the 2A outputs can be loaded to a maximum of **1.8A**.

The maximum total current is **10A**. (IO-Board)

Device	Temperature 30°C / 50°C	
	SCU-x-EC/x, SDU-x, SIO-1	QX 00 – QX 03
SCU-2EC/x, SIO-2	QX 00 – QX 03 IQ x5 – IQ x9	2 A / 1,8 A

7. Connection and installation

7.1. General notes on installation

Strictly follow the safety regulations when installing!

Protection class IP20

Route all signal lines for the interfacing of digital inputs and contact monitoring separately.

You should in any case disconnect 230VAC (*120VAC cULus*) voltages from low voltage power lines, if these voltages are used in connection with the application.

The cable lengths for digital inputs and outputs and all sensorik must normally not exceed **30 m**.

If the cable lengths exceed **30 m** you must apply appropriate measures for fault exclusion concerning impermissible overvoltage. Appropriate measures include e.g. lightning protection for outdoor lines, overvoltage protection of the indoor system, protected routing of cables.

Only cULus:

The maximum cable length of **30 m** shall not be exceeded.

Measures concerning the electromagnetic compatibility (EMC)

The SCU is intended for use in the drive environment and meets the EMC-requirements mentioned above.

It is also assumed that the electromagnetic compatibility of the overall system is ensured by application of appropriate measures.

SAFETY NOTE:

- Electric power supply lines of the SCU and "discontinuous-action lines" of the power converter must be isolated from each other.
- Signal lines and power lines of the power converter must be routed through separate cable ducts. The distance between the cable ducts should be minimum 10 mm.
- Only shielded cables must be used to connect the position and speed sensors. The signal transmission cable must be RS-485-standard compliant (lines twisted in pairs).
- Care must be taken to ensure that the shielding is correctly connected in the 9-pin SUB-D plugs of the position and speed sensors. Only metal or metal coated plugs are permitted.
- The shielding on the sensor side must comply with appropriate methods.
- Care must be taken to ensure EMC-compliant installation of the power converter technology in the vicinity of the SCU, SDU, SIO module. Special attention should be paid to the cable routing and the processing of the shielding for the motor

cable and the connection of the braking resistor. The installation guidelines of the converter manufacturer must be observed.

- All contactors in the environment of the power converter must be equipped with appropriate suppressor circuits.
- Suitable measures must be taken to protect against overvoltages.

Symbols used according to UL 61010-1



Symbol 14

- The temperature at the connection terminals can exceed 60°C. Suitable cable types must be used above this temperature.

7.2. Installation / mounting

NOTICE**Spare parts or consumables**

For the SCU assembly no spare parts or consumables are available. If need be, the assembly must be exchanged altogether. Opening or disassembling the SCU assembly is not permitted.

NOTICE**Mounting location**

The SCU assembly is exclusively installed in switch cabinets that at least meet the requirements of protection category IP54.

The assemblies must be mounted vertically on a top-hat rail.

NOTICE**Air circulation**

The vent slots must be kept sufficiently clear to warrant air circulation within the assembly.

7.2.1. Mounting

The SCUs are mounted on C standard rails by means of a snap-on latch.

The SCUs are inserted into the rail diagonally from above and then snap in in the bottom part. For disassembly of the SCUs, a screwdriver that is inserted into the slot of the latch that is lead out at the bottom. Afterwards, the screwdriver is moved upward.

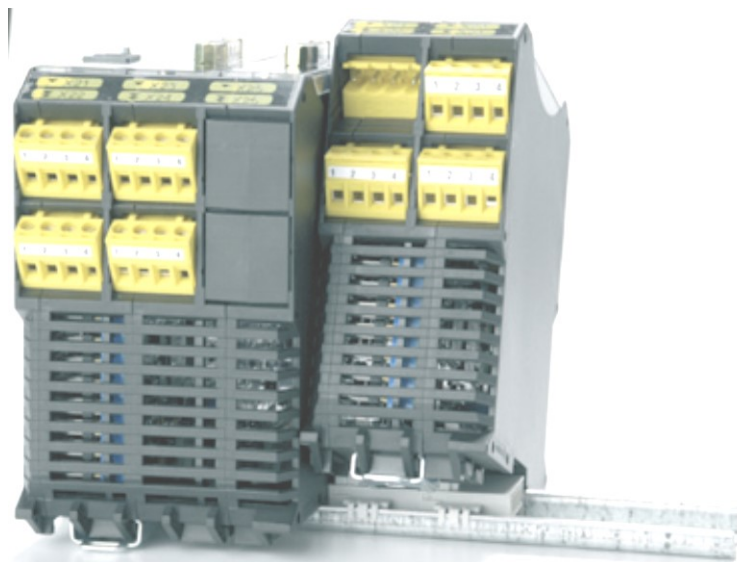

Fig. 10: mounting of the top-hat rail

7.3. Wiring**DANGER**

Work on the wiring or work at the electrical system can cause electric shock. Electric shock can cause death. Thus, only persons qualified according to TRBS 1203 may carry out work on the wiring or work on the electrical system.

Wiring of the SCU is carried out according to the terminal connection table (cf. above). First, the cables of the digital inputs and the cables of the digital outputs and the power supply cables (24 VDC and 0 VDC) must be connected to the respective terminals.

DANGER

The SCU may only be supplied by voltage sources with protective low voltage (e. g. SELV or PELV according to EN 61131-2). If an SELV voltage source is used, it can become a PELV due to the design of both the assembly and the connections. Protective low voltage circuits must always be installed in a way that they are safely insulated from power circuits with dangerous voltage. If power supply units are used, it must be guaranteed that in case of failures the maximum voltage is 60 V. The real behaviour of the power supply unit used must be inquired at the manufacturer of the respective power supply unit because according to EN 60950 in case of failure 120 V are permitted.

NOTICE

Please observe the technical data. Faulty voltage levels can damage the block and other network components.

After the power supply cables (see above) have been connected to the respective terminals, the two network cables of the EtherCAT network are connected.

To connect the two network cables, one input connector and one output connector (mains plugs) are available / are supplied.

NOTICE

The necessary cables are not included in the scope of delivery of the SCU and must be acquired separately.



7.4. Terminal schemes

7.4.1. SCU Master

- [SCU-0-EC/x](#)
- [SCU-1-EC/x](#)
- [SCU-2-EC/x](#)

7.4.2. SCU Slaves

- [SDU-11](#)
- [SDU-11/NM](#)
- [SDU-11-PXV](#)
- [SDU-12](#)
- [SDU-21](#)
- [SDU-21A](#)
- [SDU-22](#)
- [SDU-22A](#)
- [SIO-1](#)
- [SIO-2](#)
- [SSB-6-EnDAT-x](#)
- [SSB-6-DSL-x](#)
- [SSB-6-A-x](#)
- SDU-21-PXV (in preparation)

7.5. External DC 24 V – voltage supply

The SCU module requires a 24 VDC power supply (see SELV or PELV, EN50178). The following boundary conditions must be observed during project planning and installation of the intended power supply unit:

Observe the minimum and maximum tolerance of the supply voltage.

Nominal voltage	DC 24 V
Minimum: 24 VDC - 15%	DC 20,4 V
Maximum: 24 VDC + 20%	DC 28,8 V

To achieve the lowest possible residual ripple of the supply voltage, the use of a 3-phase power supply unit or an electronically controlled unit is recommended. The power supply unit must meet the requirements of EN61000-4-11 (voltage dip). The design of the connecting cables must comply with local regulations. The external voltage resistance of the SCU module is DC 32 V (protected by suppressor diodes at the input).

SAFETY NOTICE



The SCU module must be individually protected by a 3,15A (min. 30 VDC) back-up fuse which must be placed near by the terminals of the modules. Recommended fuse type:
3.15A circuit breaker (Class B) or safety fuse (inert).

Note:

Reliable galvanic isolation from the AC 230 V (120 VAC cULus) or AC 400 V network must be guaranteed in any case. For this purpose, power supply units must be selected which comply with the regulations DIN VDE 0551, EN 60 742 and DIN VDE 0160. In addition to the selection of the suitable device, potential equalization between PE and DC 0-V on the secondary side must be ensured.

SAFETY NOTICE



All GND connections of the devices, which are connected to the inputs of the SCU module must be connected to the GND of the SCU or SDU or SIO (voltage supply).

Inputs of the SCU are:

- Digital inputs
- Digital I/Os
- Analog inputs
- Encoder connections

Note:

Terminals GND_ENC and A1- are not internally connected to GND!

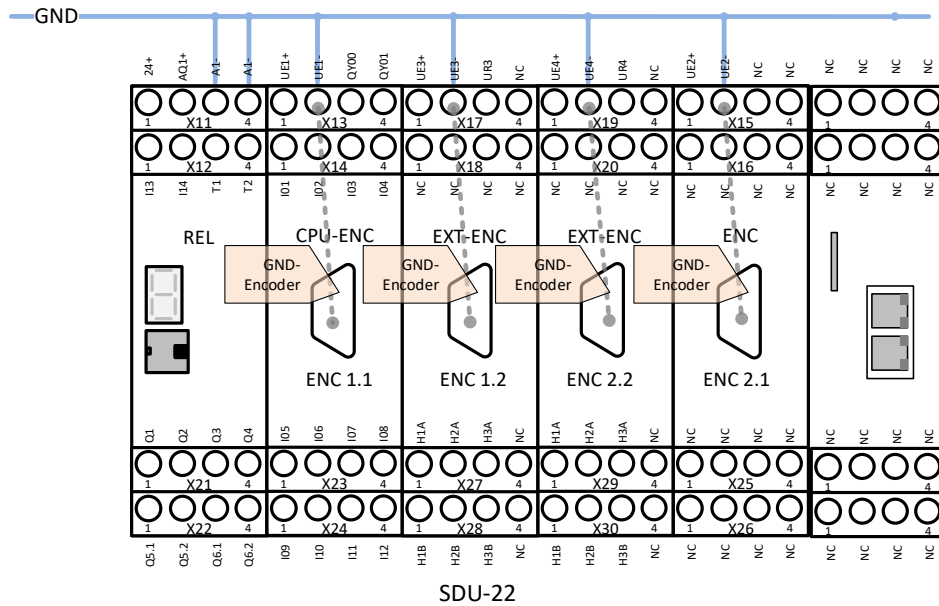

..... Internal connection e.g.: between UE1- -> 9-pin D-SUB ENC 1.1 Pin 2

7.6. Connection of the external encoder supply

7.6.1. Incremental, HTL, SIN/COS, SSI

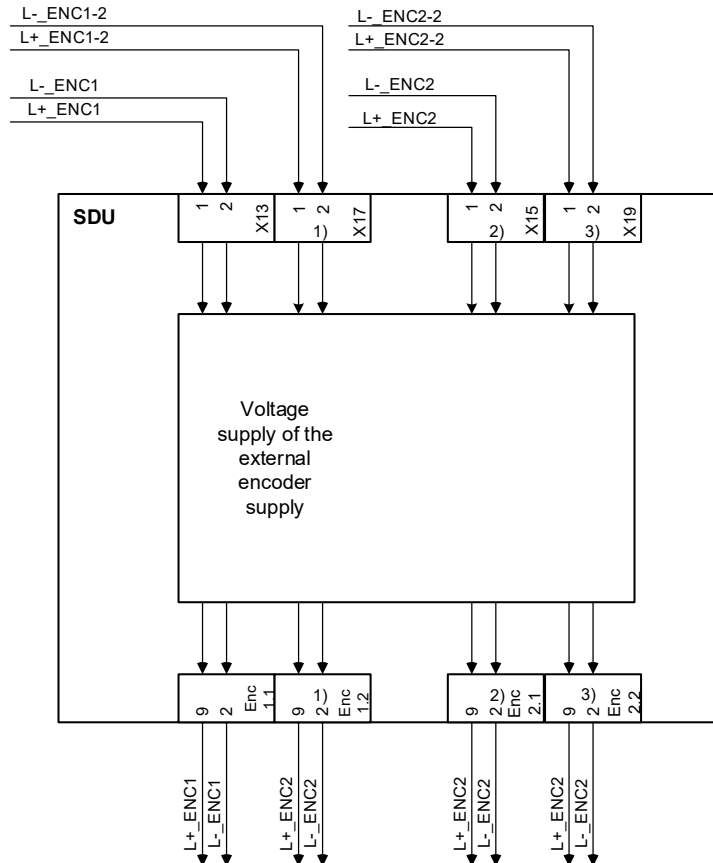

- 1) only SDU-12 and SDU-22
- 2) only SDU-21 and SDU-22
- 3) only SDU-22

The SDU module supports encoder voltages of 5 V, 8 V, 10 V, 12 V, 20 V and 24 V, that are monitored internally according to the selected configuration in SafePLC2.

If an encoder system is not supplied via the SDU module, it must be ensured that the GND of the encoder is connected to the GND of the SDU module. If the GND of the encoder is only at pin 2 of the D-sub connector, the terminal UE- (terminal X13) must also be connected to GND (see also chapter 7.5). Above that the supply voltage of the encoder must be connected to pin VCC+ (pin 9 of the D-sub connector). The terminal UE+ then remains unconnected.

The encoder supply must be protected with a fuse of max. 2A.

SAFETY NOTE

- The GND connection of the encoder must be connected to the GND of the SDU.



Monitoring of the supply voltage in accordance with the chosen nominal voltage:

Nominal voltage	Minimum voltage	Maximum voltage
5 V DC	4,4 V DC	5,6 V DC
8 V DC	7 V DC	9 V DC
10 V DC	8 V DC	12 V DC
12 V DC	10 V DC	14 V DC
20 V DC	16 V DC	24 V DC
24 V DC	20 V DC	29,5 V DC

7.6.2. Resolver

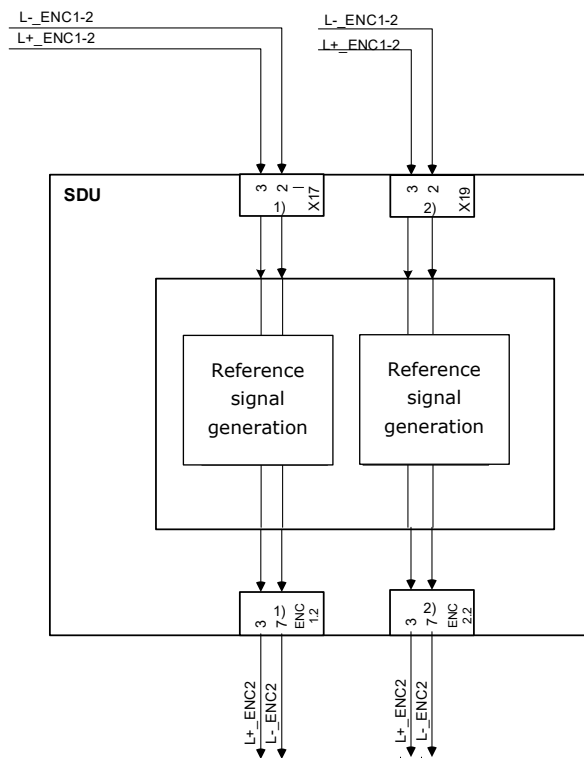

- 1) only SDU-12 and SDU-22
- 2) only SDU-22

When using resolvers in Master-Mode an additional 24V DC power supply is required for generating the reference signal

NOTICE

- Make sure that voltage supply terminals X17 and X19 are not connected to PIN 1.
- The encoder supply must be protected with a fuse of max. 2A.

Supply voltage monitoring:

Nominal voltage	Minimum voltage	Maximum voltage
24 V DC	20 V DC	29 V DC

7.7. Connection of digital inputs

The SCU modules comes with safe digital inputs. These are suitable for connecting single or two-channel signals with and without cycling, or without cross-shortening test.

The connected signals must have a "High"-level of DC 24 V (DC +15 V... + DC +30 V) and a "Low"-level of (DC -3 V... DC +5 V, Type1 acc. to IEC 61131-2). The inputs are provided with internal input filters.

A device internal diagnostic function cyclically tests the correct function of the inputs including the input filters. A detected fault will set the module into an alarm status. At the same time all outputs of the module are rendered passive.

Besides the actual signal inputs, the SCU series hold two clock outputs T1 and T2 available. The clock outputs are switching-type 24 VDC outputs.

The clock outputs are solely intended for monitoring external switching elements and cannot be used for any other function within the application. This monitoring can only be used in conjunction with the safe digital inputs. Not with the safe digital I/Os that may be present.

The switching frequency is 125 Hz for each output. In the planning stage one must bear in mind that the outputs may only be loaded with a total current of max. 250 mA.

Furthermore, approved OSSD-outputs can be connected to safe digital inputs or I/Os without limitation.

In case of single-channel use of the inputs, the achievable safety level must be limited to SIL 2 or PL d, if the safety function is demanded at regular intervals.

A safety related use of the inputs is generally only intended in connection with the clock outputs.

If clock outputs are not used, short circuits in the external wiring between different inputs and against the supply voltage for the SCU or SDU must be ruled out by external measures, appropriate routing of cables in particular.

Each input can be configured individually for the following signal sources:

Input is assigned to the cycle T1

Input is assigned to the cycle T2

Input assigned to continuous voltage DC 24 V

7.8. Connection of analog inputs

With the executions with analog processing, max. 2 analog signals to be processed safely:

The analog inputs can be connected as follows:

	min	max.
voltage	-10 V DC	+10 V DC

NOTICE

- The modules can optionally be equipped with voltage and, or current inputs.
-

SAFETY NOTE

- The GND connection AIN must be connected to the GND of the SDU.



7.9. Connection of position and speed sensors

7.9.1. General information

Depending on module type the device has external encoder interfaces for the connection of industrial incremental and absolute encoders. The encoder interfaces can be configured as incremental, SIN/COS, or as absolute SSI-encoders.

It is also possible to connect 2 incremental signal generating sensors (e.g. proximity switches) to the counting inputs of the SDU module. The signals must each be read in with normal and complementary track.

IMPORTANT:

The voltage supply of the encoder system uses the dedicated terminals on the slave module. This voltage is applied to the encoder plug and monitored by an internal diagnostic process.

When the sensor is supplied with an external voltage, this voltage must be supplied through the encoder plug. The corresponding terminal (encoder supply voltage) on the slave module remains unoccupied.

If an external sensor voltage supply is not recirculated through the encoder plug, any failure of this supply must be included in the fault examination of the overall system. This, in particular, requires evidence that this fault is detected or can be excluded when the specified operating voltage of the overall system is fallen short of / exceeded.

EMC - measures such as shielding etc. must be observed.

The two encoders must be non-interacting to each other. This applies for both the electrical as well as the mechanical part.

If both encoders are coupled to the facility to be monitored via common mechanical parts, the connection must be positively designed and should not have any parts that are susceptible to wear (chains, toothed belts, etc.). Should this be the case, additional monitoring features for the mechanical connection of the sensors (e.g. monitoring of a toothed belt) are required). In case of an active position processing at least one absolute value encoder must be used.

When using two equivalent sensors one must make sure that the sensor with the higher resolution is configured as sensor 1 (process sensor) and the sensor with the lower resolution as sensor 2 (reference sensor).

SAFETY NOTE

- The GND connections of the encoders must be connected to the GND of the slave module. This applies in the same way also to resolvers.

ATTENTION

- The sensor connections must neither be plugged on nor pulled off during operation. This could cause damage to electrical components of the encoder.
- Always de-energize connected encoders and the slave module **before** plugging on or pulling off encoder connections.
- With externally supplied encoders, pay attention to switching off the external supply voltage (e.g. converter).
- Lines twisted in pairs for signal transmission acc. to RS485 standard must be used for data and clock signals or track A and track B. The wire cross-section must in each individual case be chosen in compliance with the current consumption of the encoder and the cable length required for the installation.

The following applies when using absolute encoders:

In Slave-mode the clock signal is generated by an external process and is read in by the SDU module together with the data signal. This type of reading causes a beat which results in a reading fault of the following magnitude:

$$F = (\text{reading time of encoder by external system [ms]} / 8 \text{ [ms]}) * 100 \%$$

The size of the resulting reading fault F must be taken into account when determining the thresholds in the applied monitoring functions, because this fault cannot be compensated!

7.9.2. Assignment of encoder interface

7.9.2.1. ENC 1.1 / ENC 2.1¹⁾

Sensor assignment

Incremental - Encoder

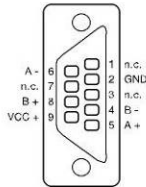

SIN/COS

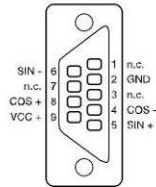

Absolut - Encoder

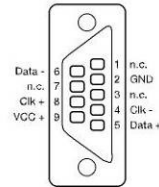

SSI - Listener

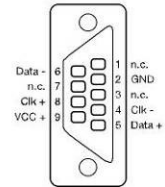

¹⁾only SDU-21

7.9.2.2. ENC 1.2 / ENC 2.2²⁾

Sensor assignment

Incremental - Encoder

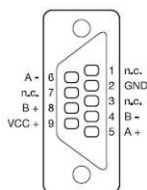

SIN/COS

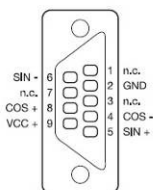
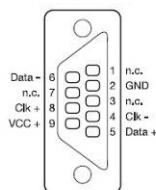
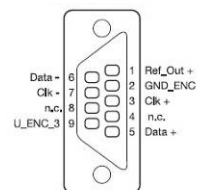
SSI - Absolut
ENC1.1/ENC2.1SSI - Absolut
ENC1.2/ENC2.2

Resolver

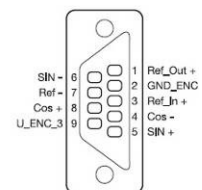

²⁾only SDU-22x

NOTICE

With the terminals ENC 1.2/ENC 2.2 of the modules SDU-12 and SDU-22x, the connection is inverse to the presented and to ENC 1.1/ENC 2.1.

with application of an incremental counting system.

With encoders not connected inversely to ENC 1.2/ENC 2.2 the direction of rotation is thus indicated inversely. The indicated direction of rotation can be corrected in the software. (see. programming manual SCU „Direction up / down“)

7.9.3. Connection variants

7.9.3.1. Connection of an absolute encoder as master

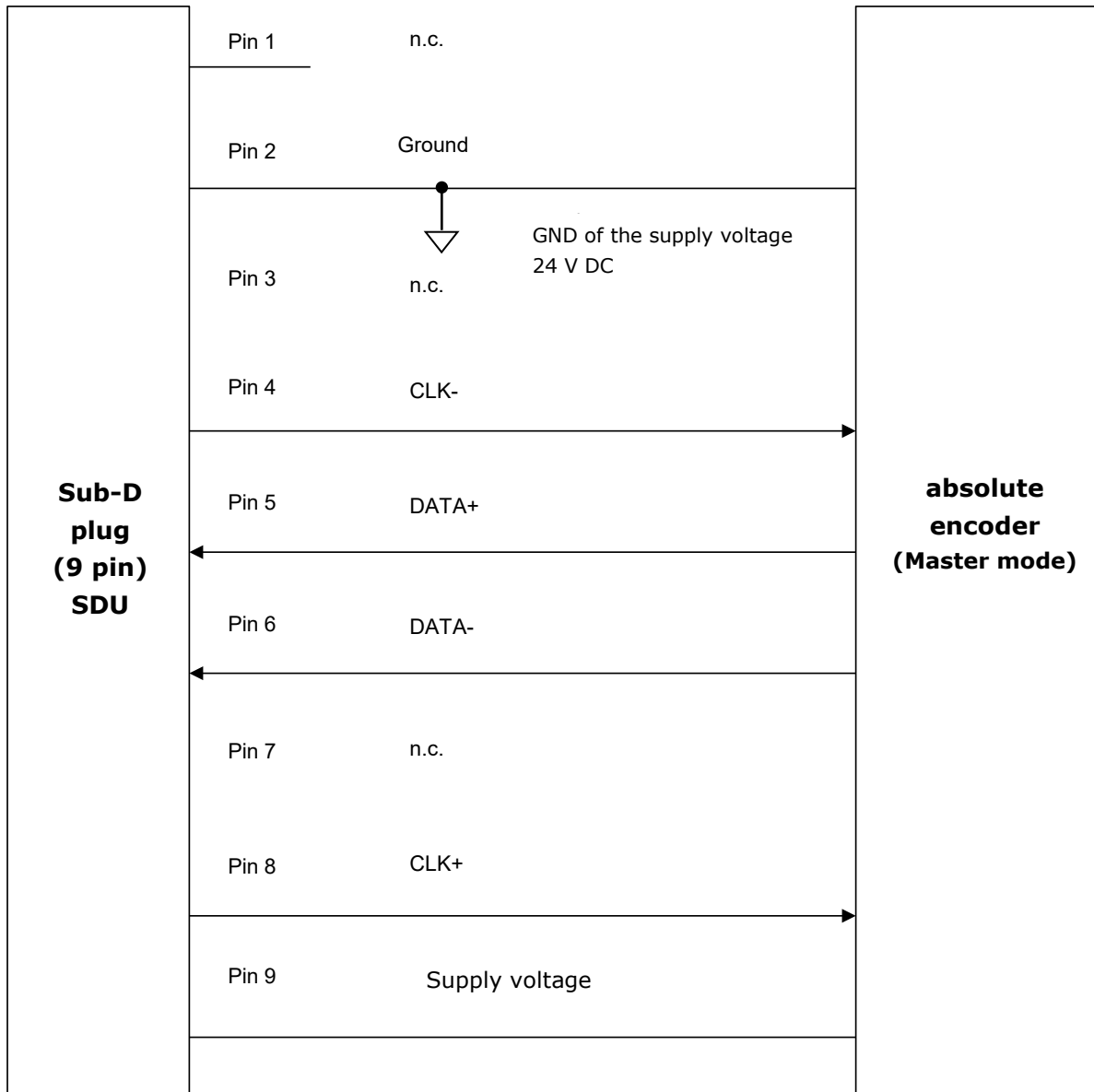

With this type of the connection the clock pulses of the module SDU run to the absolute encoder and the data from the encoder to the SDU.

7.9.3.2. Connection of an absolute encoder as slave

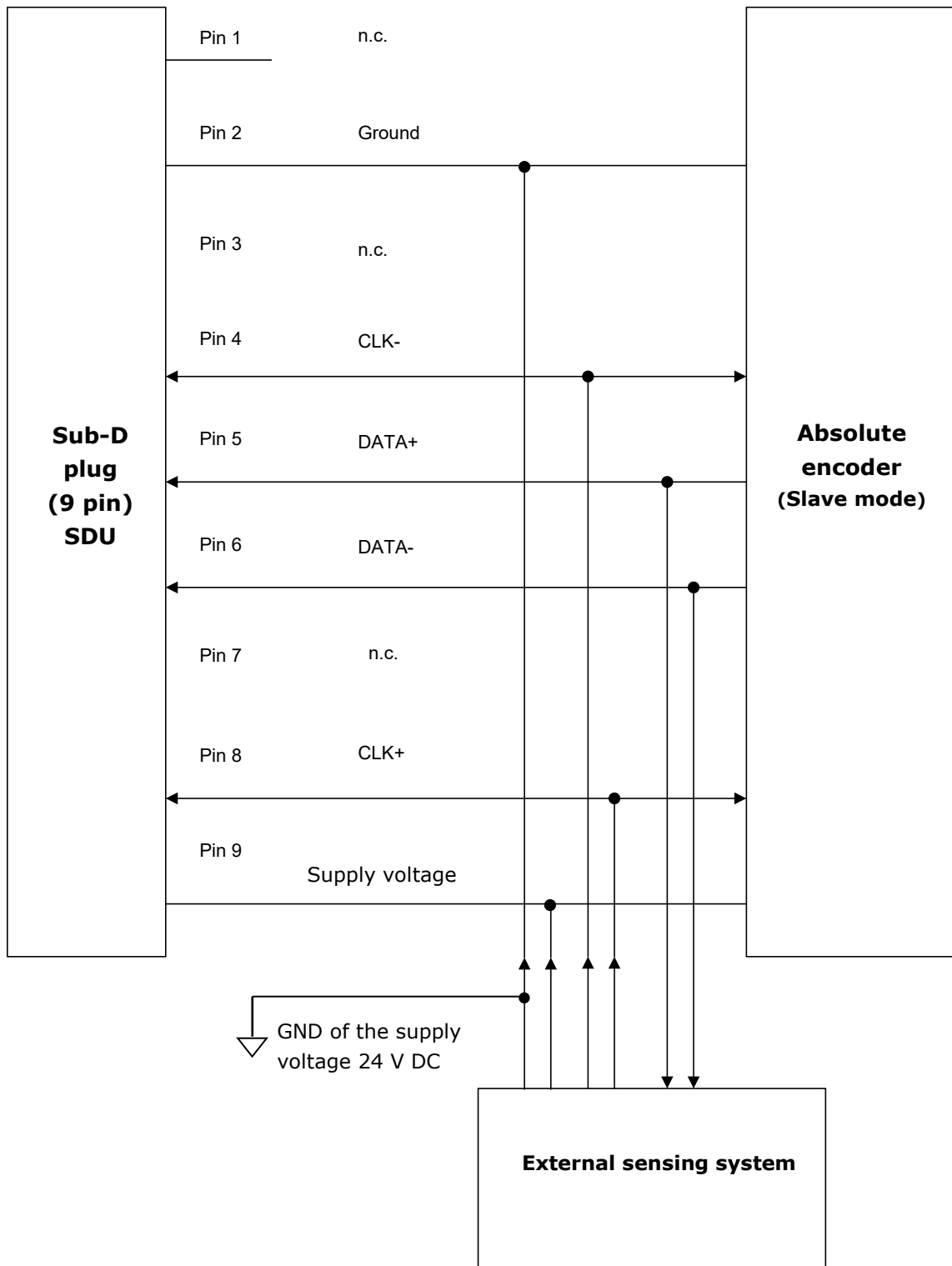

With this type of connection both clock signals and data are read in. In this example the module does not supply the encoder with voltage.

7.9.3.3. Connecting an incremental encoder with TTL-Signal level

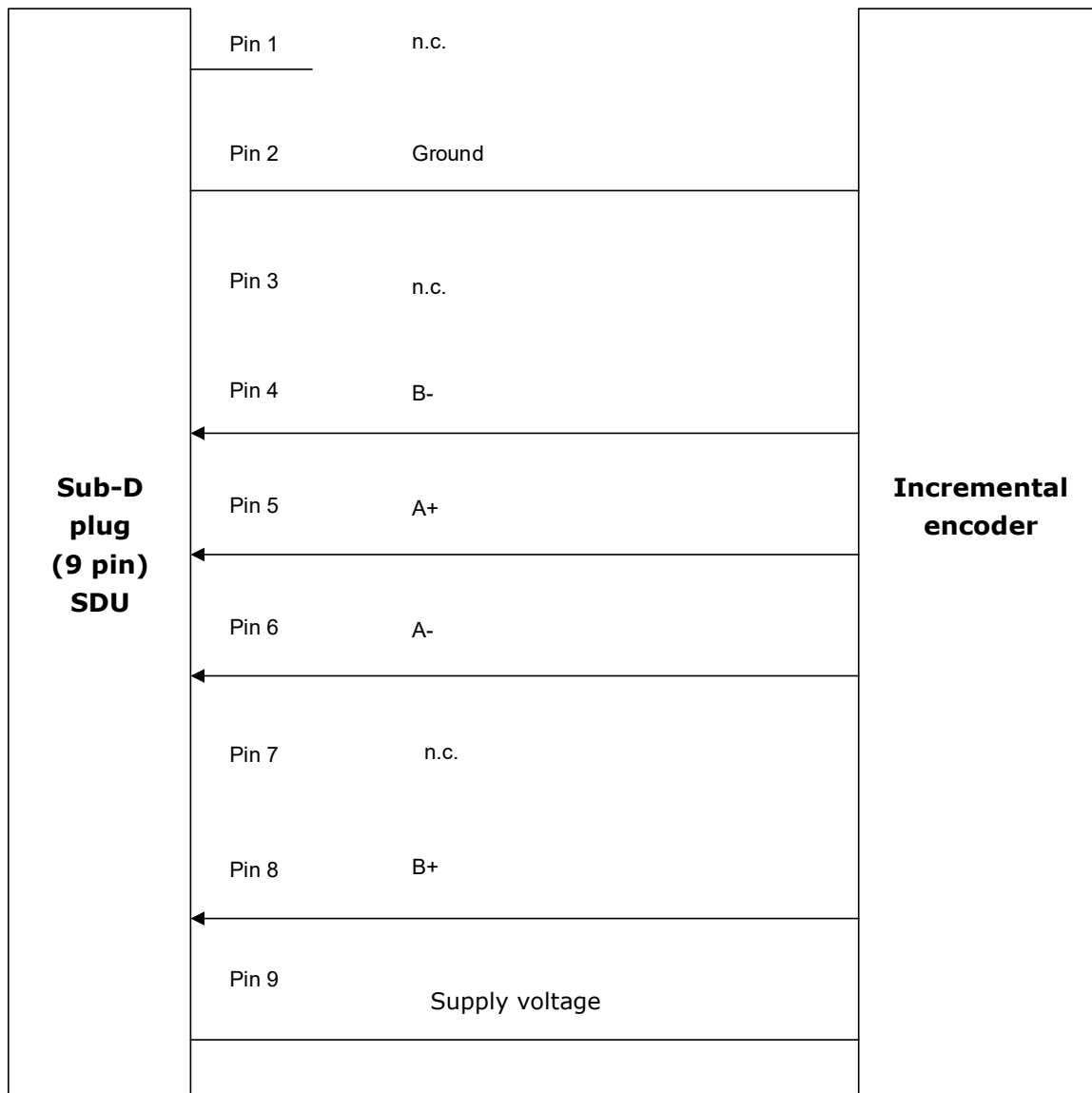

Pins 1, 3 and 7 stay open and are reserved for later expansions.

7.9.3.4. Connection of a SIN/COS encoder

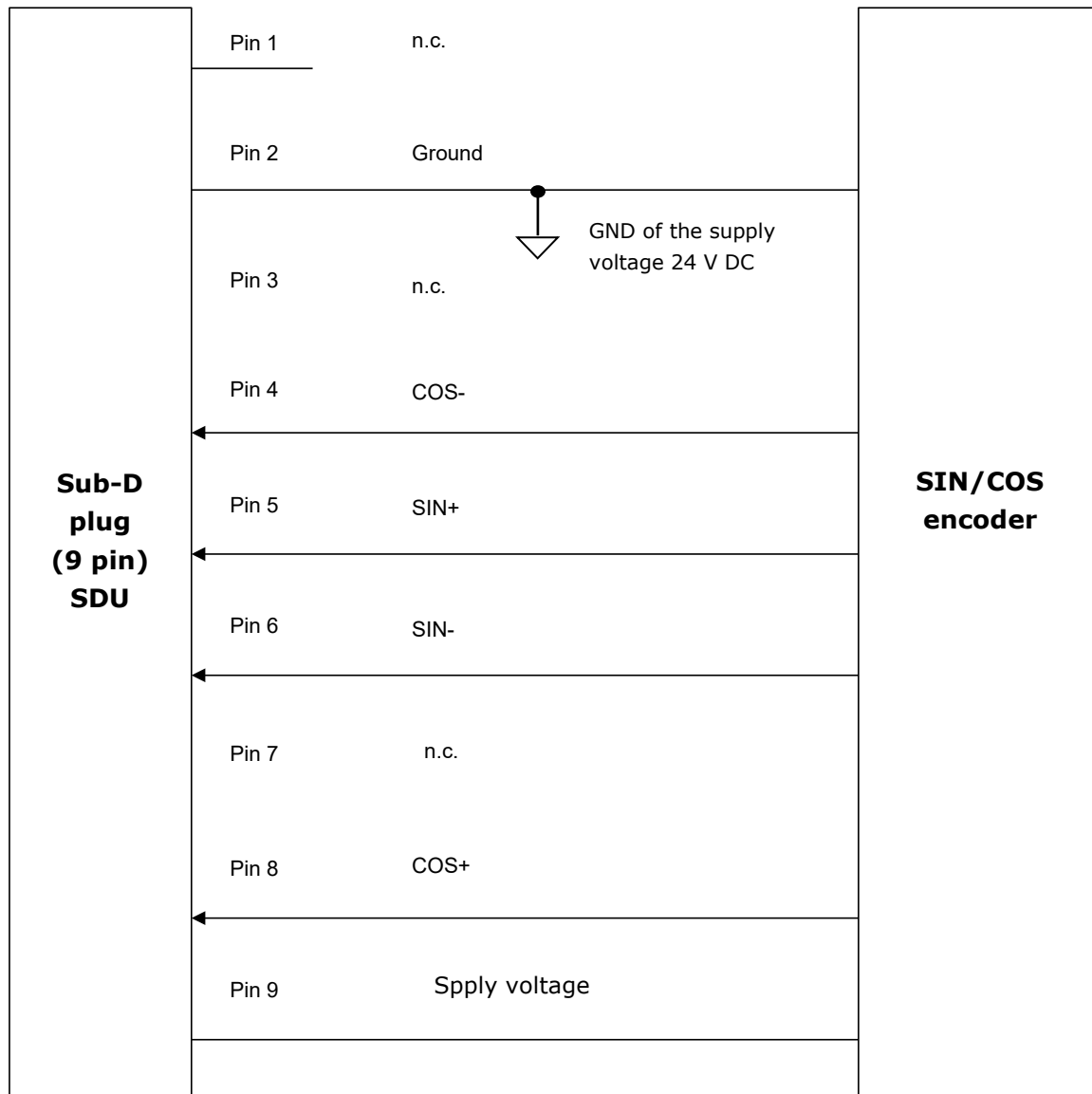

Pins 1, 3 and 7 stay open and are reserved for later expansions.

7.9.3.5. Connection of a resolver as master

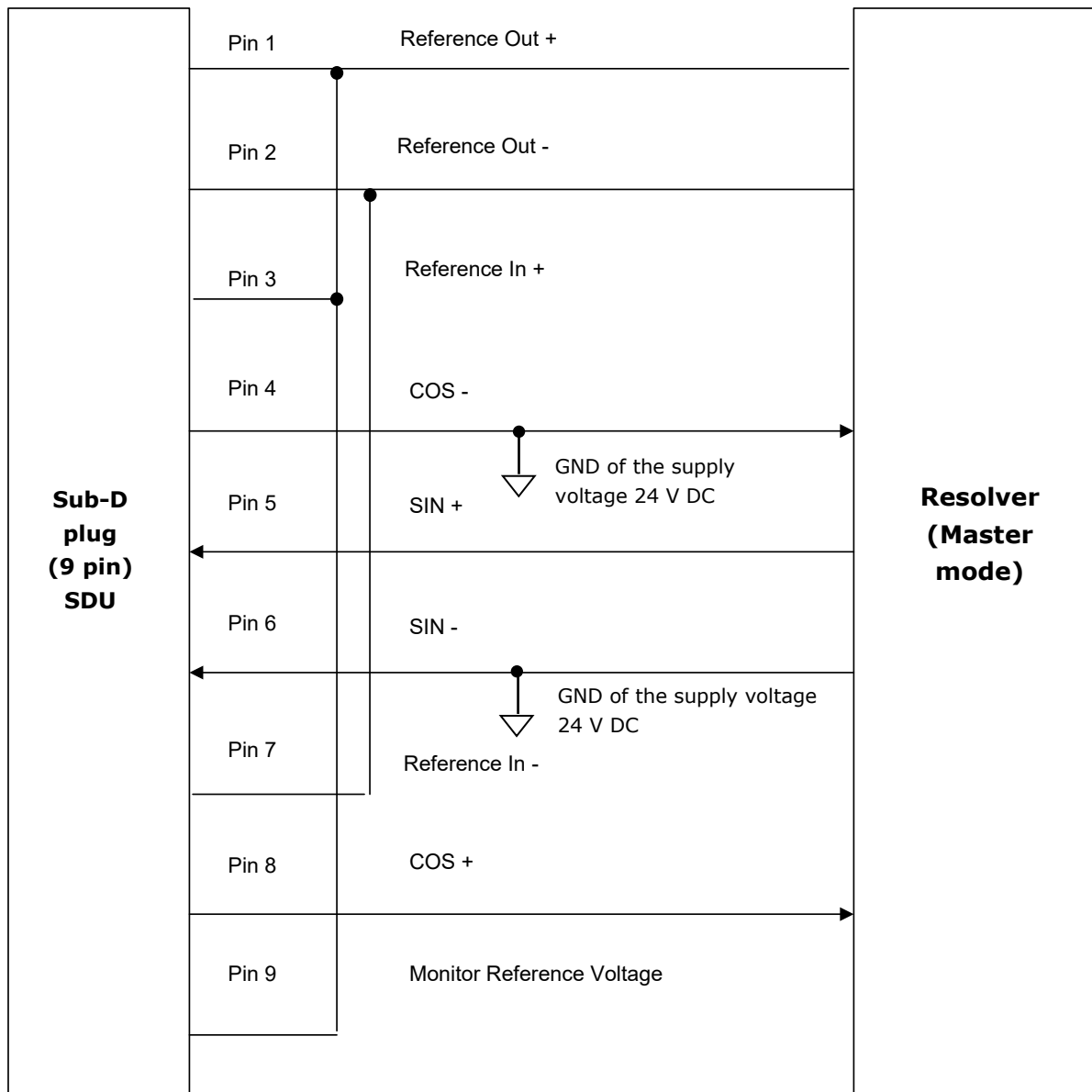

With this type of connection, the clock signals are submitted from the SDU module to the absolute encoder and the data from the encoder to the SDU.

7.9.3.6. Connection of a resolver as slave

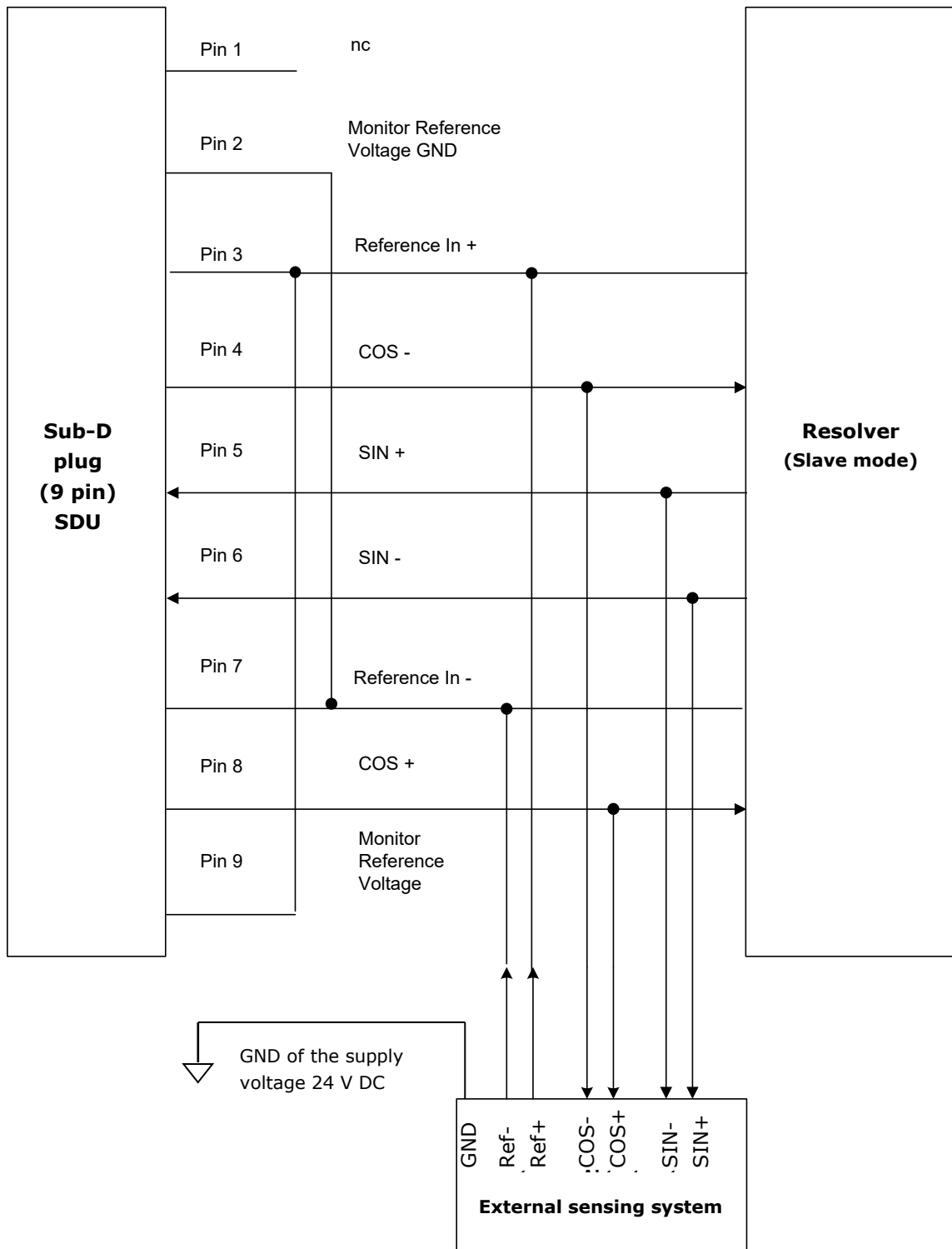

7.9.3.7. Connection of proximity switch SDU-1x/-2x

The connection is made at the digital inputs I04 ...I07.

The exact pin assignment depends on the encoder combination and is shown schematically in the wiring scheme in "SafePLC2" programming surface.

Proxy 1 counter - Proxy 1 counter

When using the Proxy1 Proxy1 encoder combination, please observe the notes in chapters 8.5 and 8.6, especially with regard to the achievable cut-off frequencies and the requirements for the code disc to be used.

The selection of the number of pulses depends on the dynamics of the axis to be monitored and the parameters of the proximity switches used (switching distance, detection lobe). General statements cannot be made at this point. A suitable design for the respective application is always required.

Proxy 2 counter

Here, signals are required that are phase-shifted by 90° to each other. The tooth form is not relevant here, but a 1:1 split of the code disc simplifies the alignment of the sensors.

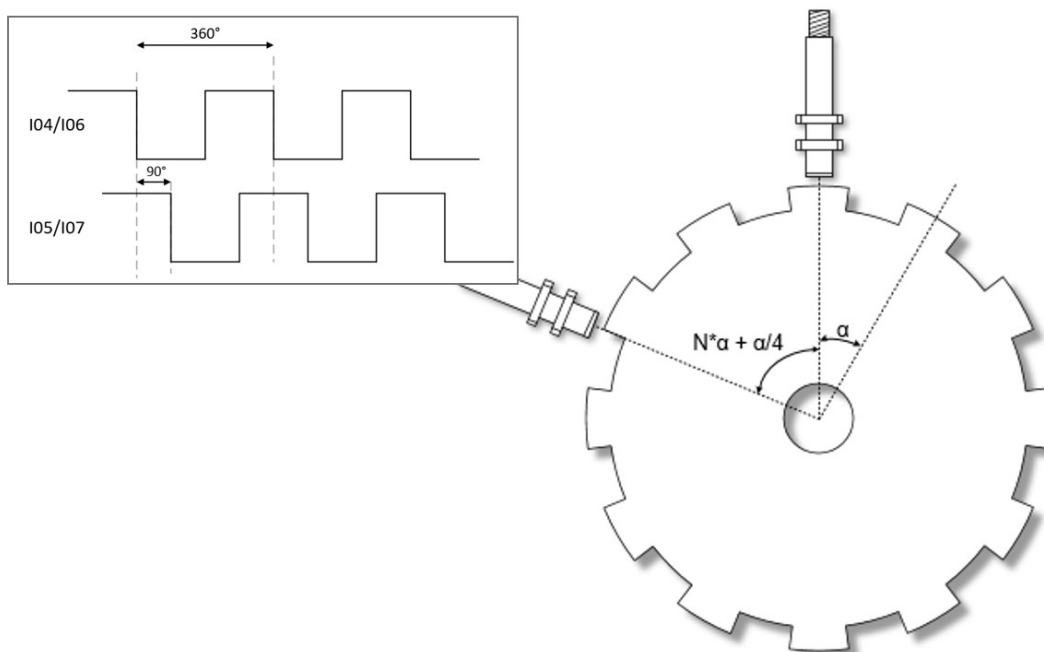

NOTICE

When using HTL-encoders, please bear in mind that tracks A+ and B+ or A- and B- must be combined accordingly.

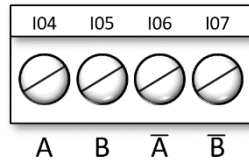

7.9.3.8. Connection of HTL/proximity switch SDU12/SDU22x

The connection is made via plug connectors X27 and X28, or X29 and X30

7.9.3.9. HTL-encoder with A+/A- or B+/B- signal

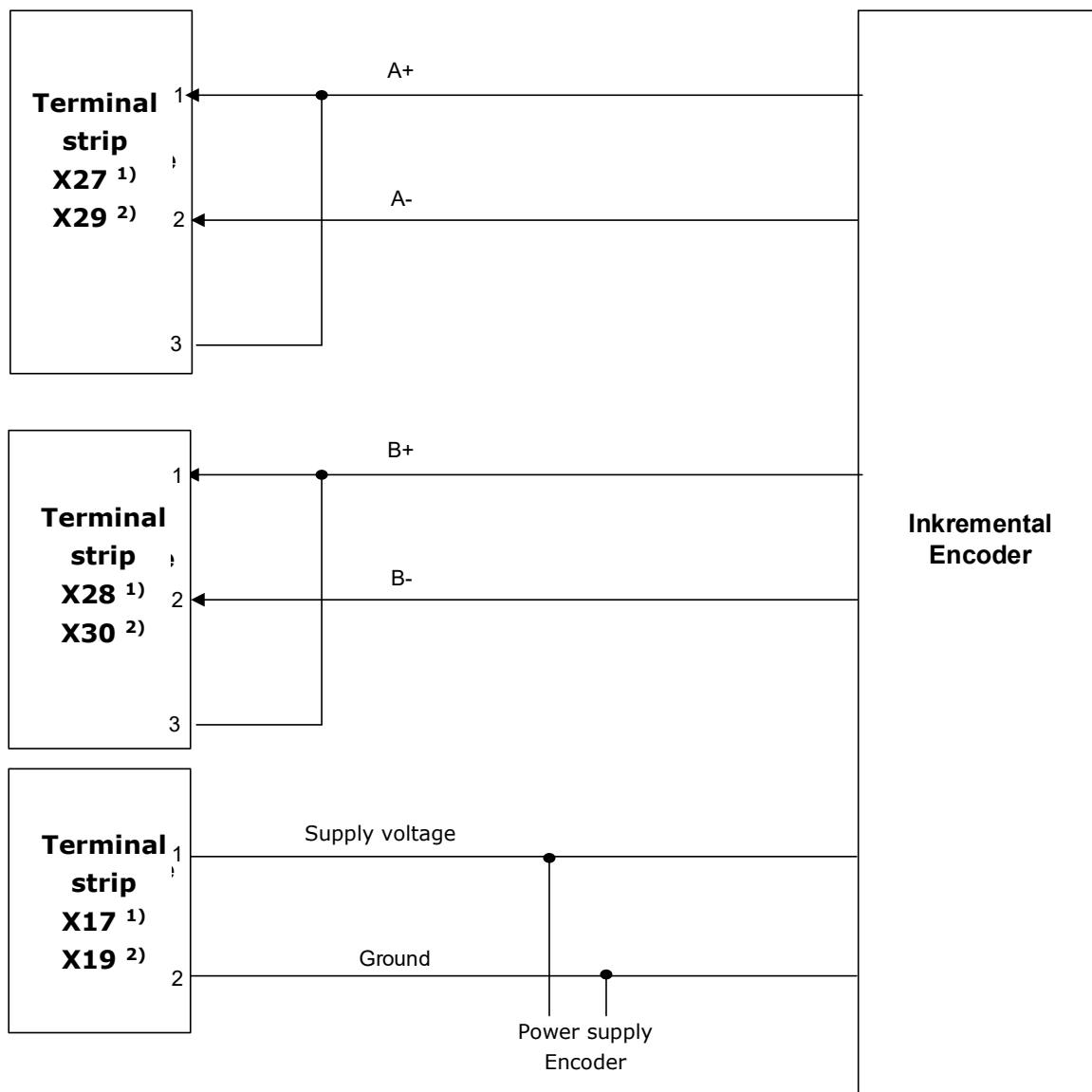

¹⁾ SDU-12 Encoder 3 ²⁾ SDU-22 Encoder 4

7.9.3.10. HTL-encoder with A+ or B+- signal

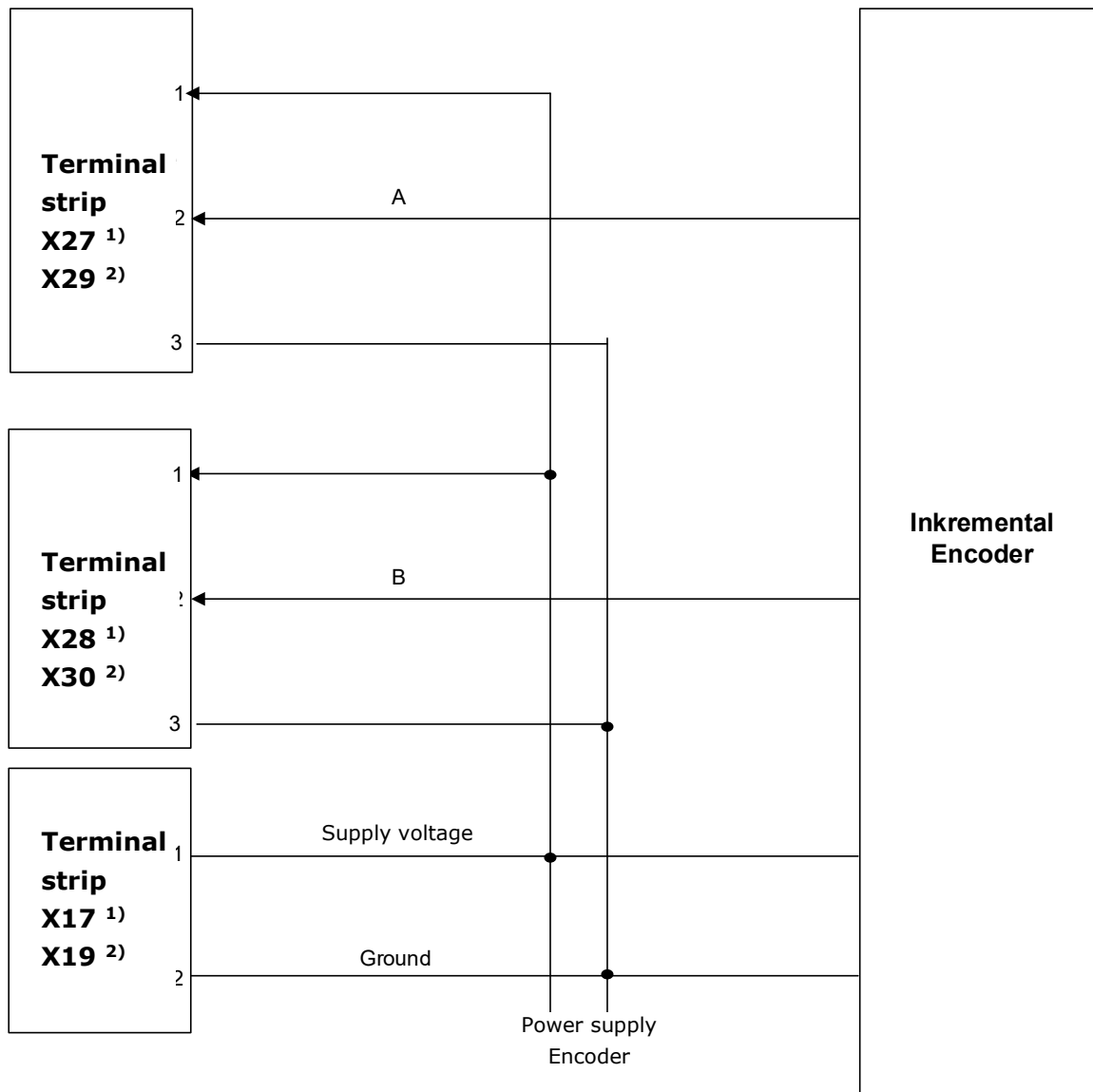

¹⁾ SDU-12 Encoder 3

²⁾ SDU-22 Encoder 4

7.10. Configuration of measuring distances

7.10.1. General description of encoder configuration

The most important input variables for the monitoring functions of the module are safe position, speed and acceleration. These are obtained by dual-channel generation from the connected sensor system. A category 4 compliant architecture, i.e. continuous dual-channel recording with high degree of diagnostic coverage, is required for PI e acc. to EN ISO 13849-1. For possible single-channel components (e.g. mechanical connection of the sensors/encoders with only one shaft/fastening) fault exclusions acc. to EN ISO 13849-2 may be used, if this should be necessary. For PI d acc. to EN ISO 13849-1 one may work with a reduced degree or diagnostic coverage. Simple design sensor systems (speed monitoring only) may under certain circumstances be sufficient under due consideration of the permissible fault exclusions acc. to EN ISO 13849-2.

See also APPENDIX 1

Further configuration is described in the programming manual:

„Programming manual SafePLC2“.

8. Sensor type diagnoses

Absolute encoder and incremental measuring systems are possible, as well as counting pulse generating proximity switches.

8.1. Absolute encoder:

Data interface: Serial Synchron Interface (SSI) with variable data length
from 12 to 28 bit.

Data format: Binary or Gray code,

Physical Layer: RS-422 compatible

SSI-Master operation:

Clock rate: 150kHz

SSI-Listener

operation (Slave mode): Max. external clock rate 250 KHz ¹⁾ or 350 kHz ²⁾.

Min. clock pause time 150 µsec

Max. clock pause time 1 msec

¹⁾on Enc 1.1/Enc 2.1

²⁾on Enc1.2/ Enc 2.2

Diagnoses:

Diagnosis	Parameters	Fault threshold
Supply voltage monitoring	Fixed values 5 V, 8 V, 10 V, 12 V, 20 V, 24 V	+/- 20% +/-2% (measuring tolerance)
Monitoring of differential level on input	Fixed value RS 485-level	+/- 20% +/-2% (measuring tolerance)
Monitoring of Clk-frequency	Fixed value	100 kHz < f < 350 kHz
Plausibility of speed versus position	Fixed value	$DP < 2 * V * T$ with T = 8 ms

Parameterization of SSI-format:

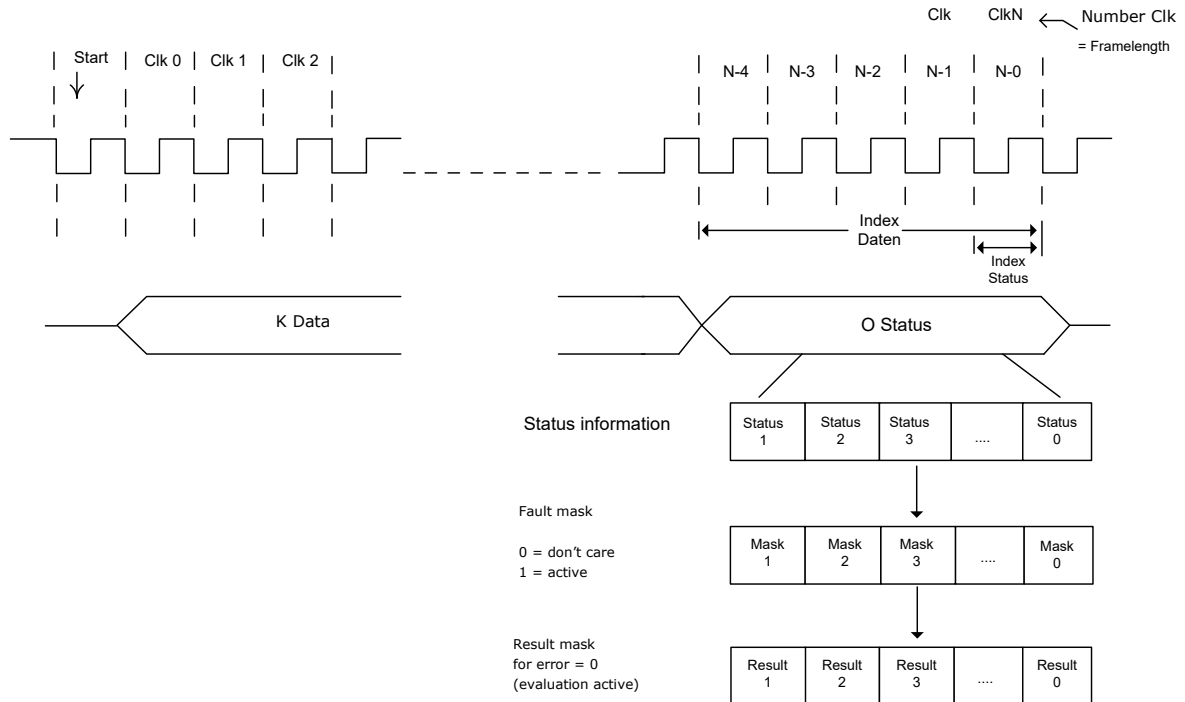

Example:

SSI-Frame Length: 28 cycles
 Data-Length: 22 bit
 Status: 5-bit, 3-bit Fault + 2-bit Warning/ready for operation

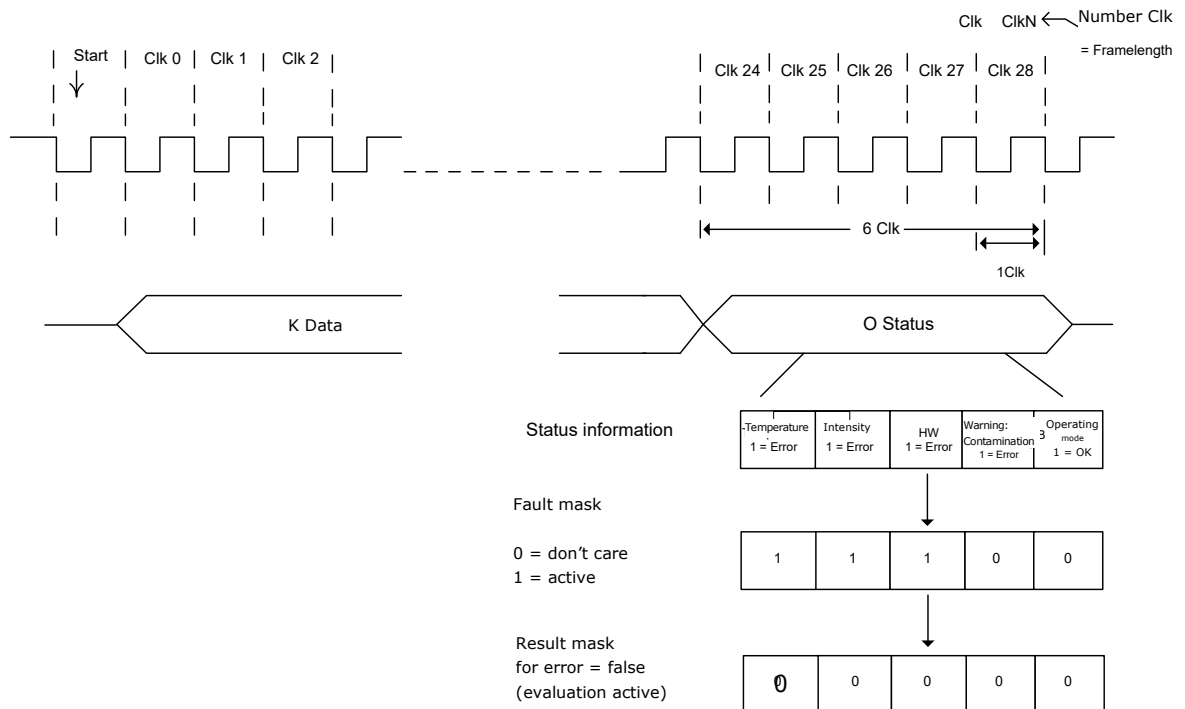

8.2. Incremental encoder:

Physical Layer: RS-422 compatible
 Measuring signal A/B: Track with 90-degree phase difference
 Maximum frequency of input cycles: 200 KHz ¹⁾ or 500 kHz ²⁾

¹⁾on Enc 1.1/Enc 2.1

²⁾on Enc1.2/ Enc 2.2

Diagnoses:

Diagnosis	Parameters	Fault threshold
Supply voltage monitoring	Fixed values 5 V, 8 V, 10 V, 12 V, 20 V, 24 V	+/- 20% +/-2% (measuring tolerance)
Monitoring of differential level on input	Fixed value RS 485-level	+/- 20% +/-2% (measuring tolerance)
Monitoring of the counting signal separated for each track A/B	Fixed value	DP > 4 Increments

8.3. SinusCosinus encoder – Standard mode

Physical Layer: +/- 0.5 V_{ss} (without voltage offset)
 Measuring signal A/B: Track with 90-degree phase difference
 Maximum frequency of input clock pulses: 200 KHz ¹⁾ or 500 kHz ²⁾

¹⁾on Enc 1.1/Enc 2.1

²⁾on Enc1.2/ Enc 2.2

Diagnoses:

Diagnosis	Parameters	Fault threshold
Supply voltage monitoring	Fixed value 5 V, 8 V, 10 V, 12 V, 20 V, 24 V	+/- 20% +/-2% (measuring tolerance)
Monitoring of amplitude SIN ² +COS ²	Fixed value 1V _{SS}	65% von 1 V _{SS} +/- 2,5% (measuring tolerance)
Monitoring of phases A/B	Fixed value 90°	+/- 30° +/-5° (measuring tolerance)

8.4. SinusCosinus encoder – High resolution mode:

Physical Layer: +/- 0.5 V_{ss} (without voltage offset)
 Measuring signal A/B: Track with 90 degree phase difference
 Maximum frequency of input clock pulses: 15 kHz ²⁾

²⁾on Enc1.2/ Enc 2.2

Diagnosen:

Diagnosis	Parameters	Fault threshold
Supply voltage monitoring	Fixed values 5 V, 8V, 10V, 12V, 20V, 24V	+/- 20 % +/-2 % (measuring tolerance)
Monitoring of amplitude SIN ² +COS ²	Fixed value 1V _{ss}	65 % of 1 V _{ss} +/- 2.5 % (measuring tolerance)
Monitoring of phases A/B	Fixed value 90°	+/- 30° +/-5° (measuring tolerance)
Monitoring of counting signal / signal phase quadrant	Fixed value	+/- 45°

8.5. Proxi – Switch

Signal Level: 24V / 0V
 Max. counting frequency: 10kHz
 Circuit logic: de-bounced

Diagnoses:

Diagnosis	Parameters	Fault threshold
Supply voltage monitoring	Fixed values 24V	+/- 20 % +/-2 % (measuring tolerance)

8.6. Extended monitoring Proximity switch / proximity switch

The extended monitoring uncovers the following faults:

- Supply voltage failure
- Failure of output signal in driver direction
- Malfunction of High signal proximity switch
- Interruption of signal path
- Mechanical de-adjustment of proximity switch / excessive switching distance of proximity switch

For diagnostic purposes both status conditions of the counting signal are additionally recorded synchronously and compared logically. A damping of at least one of the two signals must be guaranteed for each shifting gate. The logic will evaluate this instruction.

Design of switching gate with radial sensor arrangement

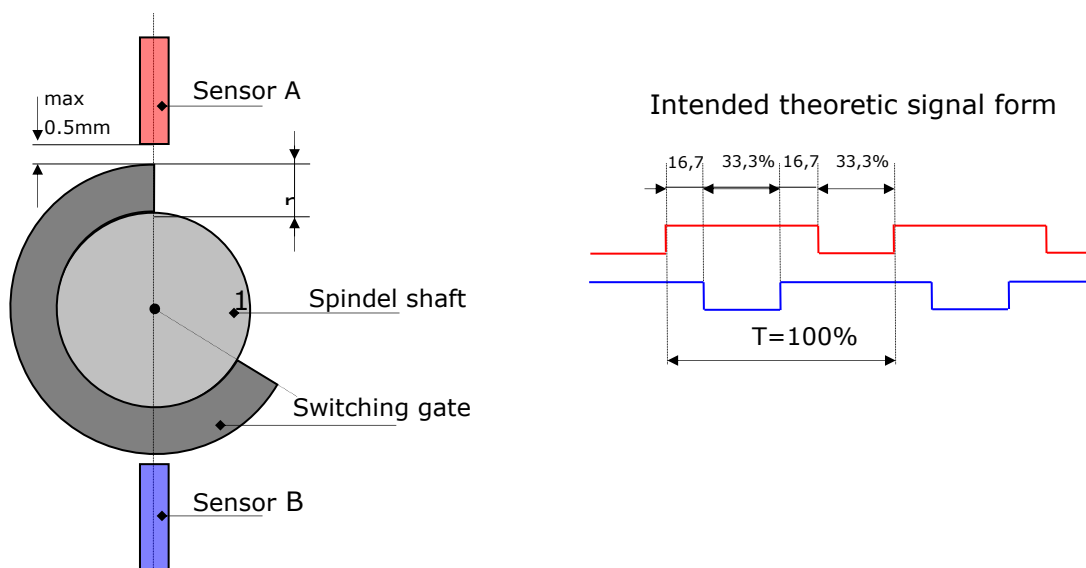

The diagnose must be designed for at least the following limiting values:

Max. counting frequency:	4 kHz
Max. blanking 0-signal:	50 %
Min. coverage:	10 %

Reading in counting signals:

The two counting signals are both separately assigned to the two channels. In each of the channels the status is read in synchronously. In order to ensure synchronization this must be carried out directly after the channel synchronization. Sampling must take place at least 1x per cycle. The max. deviation in synchronization is 20 µs.

The status conditions must be exchanged crosswise through the SPI.

Logic processing:

The following evaluation must be made in both channels:

Signal A	Signal B	Result
Low	Low	False
High	Low	True
Low	High	True
High	High	True

8.7. HTL – Sensor

Signal level:	24V/0V
Physical Layer:	Push/Pull
Measuring signal A/B:	track with 90° phase difference
Max. counting clock frequency: (only SDU12, SDU-22)	200 kHz at X27/28 or X29/30

Diagnoses:

Diagnosis	Parameters	Fault threshold
Supply voltage monitoring	Fixed values 5 V, 8V, 10V, 12V, 20V, 24V	+/- 20 % +/-2 % (measuring tolerance)
Monitoring of differential level on input	Fixed value 24 V	+/- 20 % +/-2 % (measuring tolerance)
Monitoring of the counting signal separated for each track A/B	Fixed value	DP > 4 increments

8.8. Resolver

Measuring signal: SIN/COS – track with 90° phase difference
 Max. counting clock frequency: 2 kHz/ pole
 Resolution: 9 bit / pole

Master-Mode:

Frequency reference signal: 8 kHz

Slave-Mode

Frequency reference signal: 4 - 16 kHz
 Reference signal form: Sinusoidal, triangle, rectangle

¹⁾on Enc 1.1/Enc 2.1

²⁾on Enc1.2/ Enc 2.2

Diagnoses:

Diagnosis	Parameters	Fault threshold
Monitoring of ratio	2:1, 3:2, 4:1 (parameterizable)	+/- 20 % +/-2 % (measuring tolerance)
Monitoring of signal amplitude	(Depending on the ratio)	Min: 3.8 V _{ss} +/-5 % (measuring tolerance) Max: 8 V _{ss} +/-5 % (measuring tolerance)
Monitoring of phases A/B	Fixed value 90°	+/- 7° +/-2° (measuring tolerance)
Monitoring of reference frequency	4 kHz to 16 kHz (parameterizable)	+/- 20% +/-5% (measuring tolerance)
Form of reference signal	Sinusoidal, triangle, rectangle, no monitoring (parameterizable)	40 % form deviation
Monitoring of counting signal / signal phase quadrant	Fixed value	+/- 45°

Note: A strong deviation of the input voltage curve from the sinusoidal shape can possibly lead to an early triggering of the diagnosis.

9. Reaction time

The reaction period is an important safety feature. The reaction time must be considered for every application / for every applicative safety function. The following chapter lists the reaction periods for particular functions. If need be, the reaction periods are listed in relation to other parameters. If this information is not sufficient for a specific application, the actual time behaviour must be validated against the target behaviour by means of separate measurements. This concerns especially the use of filtering functions.

DANGER

Significant impairment of safety with incorrectly determined reaction times

- The reaction times for every applicative safety function must be determined in nominal behaviour and must then be compared with the actual value. For this comparison the information given below must be used.
- Particular care must be taken when using filter function. Depending on filter length / filter time, the reaction period can be considerably longer. This prolongation of the reaction time must be considered during the safety relevated design.
- In case of particularly critical problem formulations the temporal behaviour must be validated by means of measurements.
- During start-up of the device / alarm reset or error reset the outputs may (depending on the application program) become active over the response time period. This must be taken into consideration when planning the safety function.
- When using safe field bus connections, (FSoE), the system run-time (watchdog) must be included.

9.1. Response time at standstill:

Reaction periods are calculated on the basis of the cycle time of the **SCU** system. During operation, the cycle time of the SCU system is **T_{cycle} = 16 ms**.

The indicated response times correspond to the respective maximum runtime for the specific application within the SCU module.

Depending on the application, further application independent response times of the sensors and actuators used must be added.

Function	Reaction time [ms]		Explanation
	Typical	Worst-case	
Activation of digital output via digital input	21	38	Activation of one input, logic processing and switching of the output
Activation of relay output via digital input	31	52	Activation of one input and switching of the output
Deactivation of digital output via digital input	26	41	Deactivation of one input and thus deactivation of the output
Deactivation output relay via digital inputs	44	64	Deactivation of one input and thus deactivation of the relay output
Activation of digital output via input at FSoE Slave	27 ¹⁾	42 ¹⁾	Activation of one input at one FSoE Slave. Logic processing and switching of the local output at SCU
Activation of output relay via digital input at FSoE Slave	39 ¹⁾	57 ¹⁾	Activation of one input and switching of the output
Deactivation of digital output via digital input at FSoE Slave	29 ¹⁾	46 ¹⁾	Deactivation of one input and thus deactivation of the output
Deactivation of relay output via digital input at FSoE Slave	47 ¹⁾	64 ¹⁾	Deactivation of one input and thus deactivation of the relay output
Activation of digital output in FSoE Slave via input at FSoE Slave	47 ¹⁾	63 ¹⁾	Activation of one input at one FSoE Slave, logic processing and switching of the local output at SCU
Deactivation of digital output in FSoE-Slave via digital input at FSoE-Slave	49 ¹⁾	66 ¹⁾	Deactivation of one input and thus deactivation of the output
Activation of a monitoring function by ENABLE	21	32	Activation of an internal monitoring function by the ENABLE signal

Function	Reaction time [ms]		Explanation
	Typical	Worst-case	
Reaction of an already activated monitoring function including PLC edit in case of position processing and speed processing via digital output	21 ²⁾	39	If the monitoring function that has already been activated by ENABLE, the block needs <u>one</u> cycle to calculate the current speed value. In the next cycle, after the monitoring function has been calculated, the information is processed and edited via the PLC. That means, according to the implemented logic this leads e. g. to the switching of one output.
Reaction of an already activated monitoring function including PLC edit in case of position processing and speed processing via digital output.	39 ²⁾	62 ²⁾	If the monitoring function that has already been activated by ENABLE, the block needs <u>one</u> cycle to calculate the current speed value. In the next cycle, after the monitoring function has been calculated, the information is processed and edited via the PLC. That means, according to the implemented logic this leads e. g. to the switching of one output.
Calculation SARC	16	16	Calculation of SARC blocks within a cycle.
Use virtual axes for monitoring functions	32	32	Calculation virtual axes and provide for use in the monitoring functions
Error reaction time SARC	32	32	Error reaction time for SARC calculations

Table 1: reaction time

NOTICE

- ➔ 1): Applies to EL1904, EL2904 and SSM
- ➔ 2): If a mean value filter is used, its reaction period must be added.

This results in the following formulae for the typical reaction time:

- Reading in of digital input of FSoE Slave on digital output of Master

$$T_{\text{typ}} = 2 * T_{\text{Slave}} + X * T_{\text{ECAT}} + 2 * T_{\text{Zyklus}}$$

- Reading in of digital input of SCU on digital output of FSoESlave

$$T_{\text{typ}} = 1.5 * T_{\text{Zyklus}} + X * T_{\text{ECAT}} + 1.5 * T_{\text{Slave}}$$

- Reading in of digital input of FSoESlave on digital output of FSoESlave

$$T_{\text{typ}} = 1.5 * T_{\text{SlaveSDI}} + X * T_{\text{ECAT}} + T_{\text{Zyklus}} + 1.5 * T_{\text{SlaveSDO}}$$

T_{Slave} = processing period Slave

T_{ECAT} = processing period EtherCAT

X = 1: synchronous to DC/FSoE Master

X = 2: asynchronous to FSoE Master

$T_{\text{WD FSoE}}$ = 16 ms ...XXX ms

T_{Zyklus} = 16 ms

In the worst case scenario, the watchdog time of the FSoE connection must be included.

Reaction time_{WorstCase} = 2 * T_{Watchdog} + reaction time_{Output}

Reaction time_{Output} : Reaction time of output at the corresponding assembly

9.2. Response time of FSoE in Fastchannel operation:

The basis of the calculation of response times of the Fastchannel connection is the Fast Channel processing time + transmission time EtherCAT.

Fast Channel processing time: $T_{FCcycle} = 2 \text{ ms.}$
 Transmission time: $T_{transmission} = 4 \text{ ms.}$

The Fastchannel response time on the side of the SCU is $2*(T_{FCcycle} + T_{transmission})$.

To this the Response time of the Slave block is added.

Response time_{max} = 2* response time_{Slave} + 2*(T_{FCcycle} + T_{transmission})

For the worst case treatment, the Watchdog time of the FSoE connection must be included.

Response time_{WorstCase} = 2* T_{Watchdog} + response time_{Output}

Response time_{Output} : response time of the output at the corresponding Slave

9.3. Response times for error distance monitoring

The following calculation scheme results for the calculation of the WorstCase conditions:

System's speed at the time of scanning	$V(t)$
System's speed at the reaction of the SCU:	$V_{A1} = \text{without filter}$
	$V_{A2} = \text{with filter}$
Threshold value ($t_{\text{threshold value}}$ for monitoring SLS or SCA):	$V_S = \text{constant for all } t$
Parameterized filter value:	$X_F = \text{constant for all } t$
Maximum possible acceleration of the application:	$a_F = \text{constant for all } t$
Delay after shutdown:	$a_V = \text{constant for all } t$
Scanning time for occurrence of a WorstCase event:	T_{error}
Response time of the SCU system:	t_{react}
Response time of the SCU system:	t_{filter}

For WorstCase consideration, it is assumed that at first the drive moves exactly on the parametrized threshold V_0 at a speed $V(s)$, and that afterwards it accelerates at the maximum possible value a_F .



Diagramm 1: Drive response with / without overspeed distance

The following applies for the courses of **V** and **s** the following relations result **without** Overspeed distance:

Parameters	Method of calculation	Remark
t_{Reakt}	Value from information about response time SCU + Deceleration time in external disabling string	Deceleration time in external disabling string from information by relay manufacturer / contactor manufacturer / brake manufacturer etc.
a_F, a_v	Not specified	Estimation from application
V_{a1}	$= V_S + a_F * t_{\text{react}}$	

Table 2: calculation of response time without Overspeed

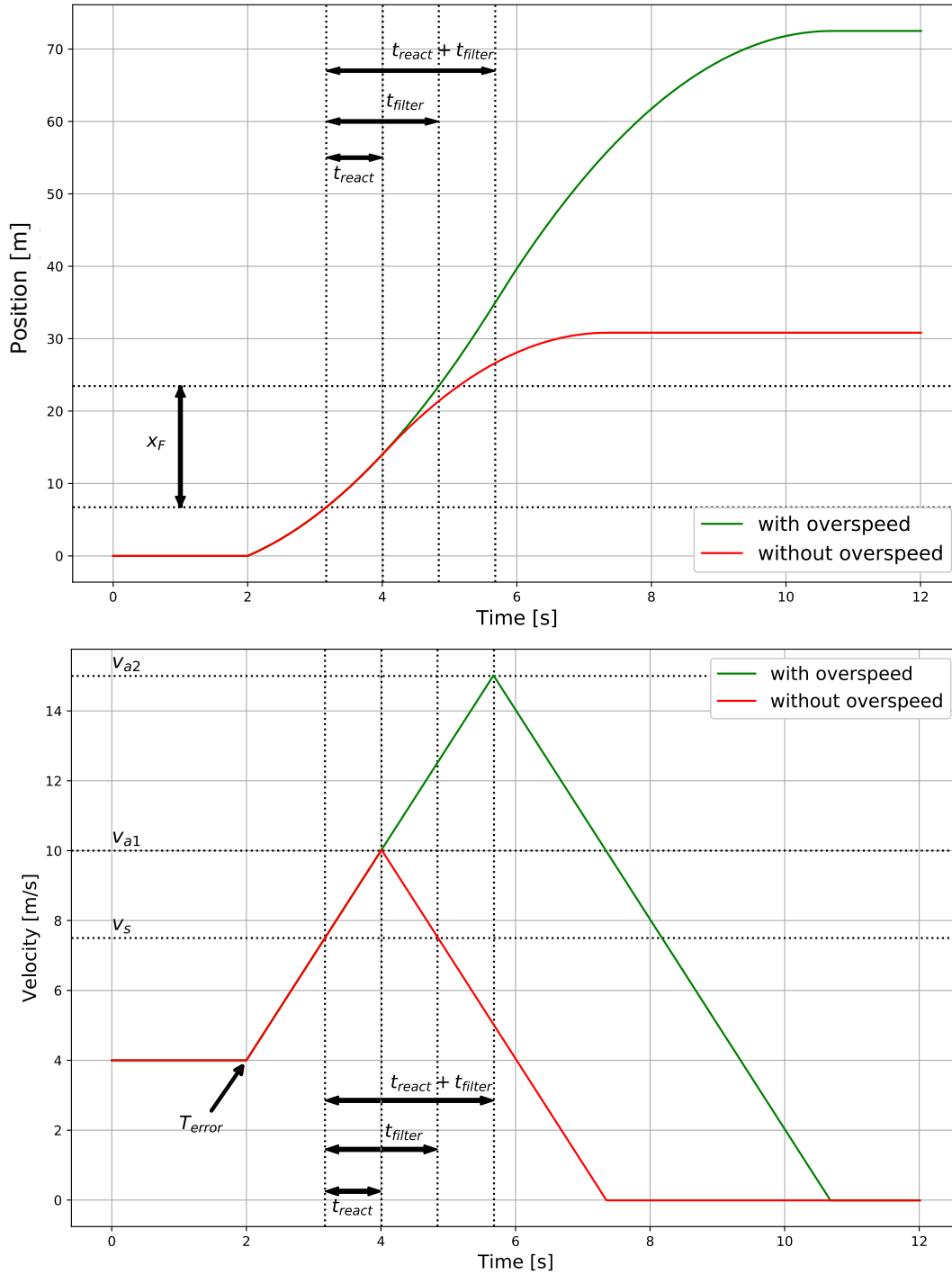
The following applies for the courses of **V** and **s** **with** Overspeed distance:

Parameters	Method of calculation	Remark
t_{react}	Value from information about response time SCU + deceleration time in external disabling string	Deceleration time in external disabling string from information by relay manufacturer / contactor manufacturer / brake manufacturer etc.
a_F, a_v	not specified	Estimation from application
V_{a2}	$= a_F * t_{\text{react}} + (V_S^2 + 2 * a_F * X_F)^{1/2}$	

Table 3: calculation of response time with Overspeed

NOTE



➔ The effect of the filter is that the set speed threshold V_a is pushed upward by a value **delta_v_filter** [ΔV_{Filter}]. For the application, the new values for the response time ($T_{\text{react}} = T_{\text{scu}} + T_{\text{filter}}$), as well as the speed resulting thereof must be considered when switching off by the safety control.

V with Overspeed Distance [m/s]

V without Overspeed Distance [m/s]

10. Safety-related characteristics

10.1. Internal architecture

The internal structure of the SCU units follows category 4 according to EN 13849-1:
Two separate channels with mutual comparison of results.
Additionally, high-grade diagnostics are carried out for error recognition.

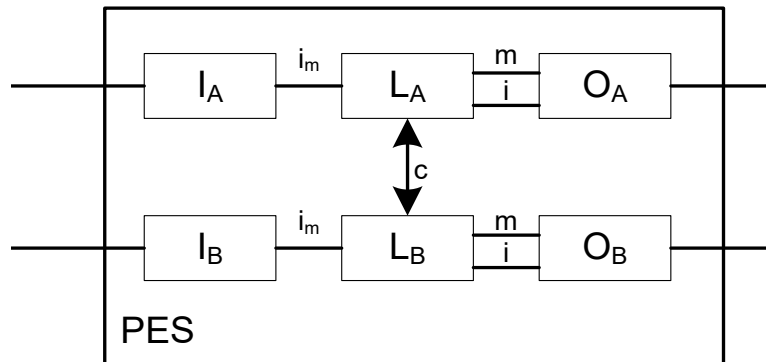

Fig. 11: 2-channel architecture

Thus, the total architecture shows the following structure:

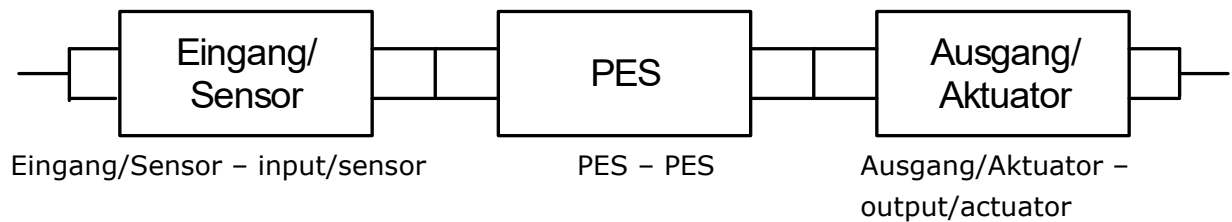

Fig. 12: total architecture

Double import of every input and diagnostics by cross-comparison

The specific safety-related characteristics must be taken from the technical characteristics indicated in chapter 6.

For the safety-related evaluation of complete systems, for the subsystem PES the identification data indicated in chapter 3 can be used (e. g. PL e and PFH value according to table for proof according to EN ISO 13849-1)

Safety-related characteristic data:

Max. achievable safety class	SIL 3 according to IEC 61508 Category 4 according to EN ISO 13849-1 Performance level e according to EN ISO 13849-1	
System structure	2-channel with diagnostics (1002) according to IEC 61508, Architecture category 4 according to EN ISO 13849-1	
Design of the operating mode	„high demand“ according to IEC 61508 (high demand rate)	
Probability of a dangerous failure per hour (PFH value)	SCU-0-EC	PFH= $7,68 \cdot 10^{-9}$
	SCU-1-EC	PFH = $7,86 \cdot 10^{-9}$
	SCU-2-EC, SIO-2	PFH = $7,96 \cdot 10^{-9}$
	SDU-x	PFH = $2,0 \cdot 10^{-9}$
	SIO-1	9,2 FIT
	SSB-6-EnDat	PFH = $1,713 \cdot 10^{-8}$
	SSB-6-DSL	PFH = $1,795 \cdot 10^{-8}$
Specific values according to "Safety characteristics" tables		
Proof test interval (IEC 61508)	20 years, after that the assembly must be replaced	

SAFETY-NOTICE



- The specific safety related characteristic data of the corresponding module can be taken from the technical characteristic data in chapter 6.
- When using several sensors with different functions (e.g. position indicator access door + speed detection) for a safety function (e.g. safe reduced speed when access door is open), these must be assumed as being connected in series for the safety related assessment of the overall system. See also exemplary calculation in appendix.
- The safety regulations and EMC-directives must be strictly followed.
- Concerning the applicable fault exclusions please refer to the tables under D in the appendix of EN 13849-2.
- The characteristic data specified in chapter 6 for the partial system PES (e.g. PL e and PFH-value acc. to table as evidence acc. to EN ISO 13849) can be used for the safety related assessment of the overall system.

The following examples and their characteristic architecture are mainly responsible for the assignment to a category acc. to EN ISO 13849-1.

The maximum possible Performance Levels acc. to EN ISO 13849-1 resulting from this still depend on the following factors of the external components:

- Structure (simple or redundant)
- Detection of common cause faults (CCF)
- Degree of diagnostic coverage on request (DC_{avg})
- Mean time to dangerous failure of a channel ($MTTF_d$)

10.2. Safety related characteristic data and wiring for the connected sensors

Each SCU unit has completely separated signal processing paths for every safety input. This applies for both the digital and the analog inputs. Furthermore, measures for achieving the highest possible DC-values have been implemented.

10.2.1. Digital sensors

Digital inputs and outputs are generally of a completely redundant design, except the electro-magnetic input terminal. The following list contains details for classification, the DC and the achievable PI or SIL.

10.2.1.1. Characteristics of sensors / input elements

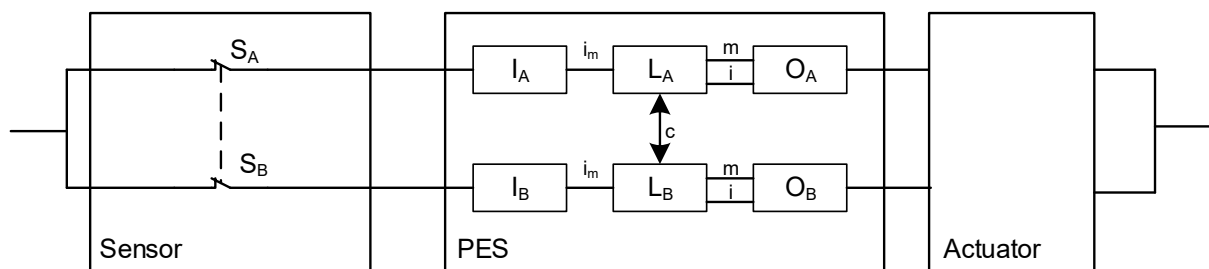

Fig. 13: Digital sensor 2-channel parallel

Two-channel input element in parallel connection (cat. 4, fault tolerance 1) with high DC due to signal processing in two channels and diagnostics by means of cross comparison in the PES.

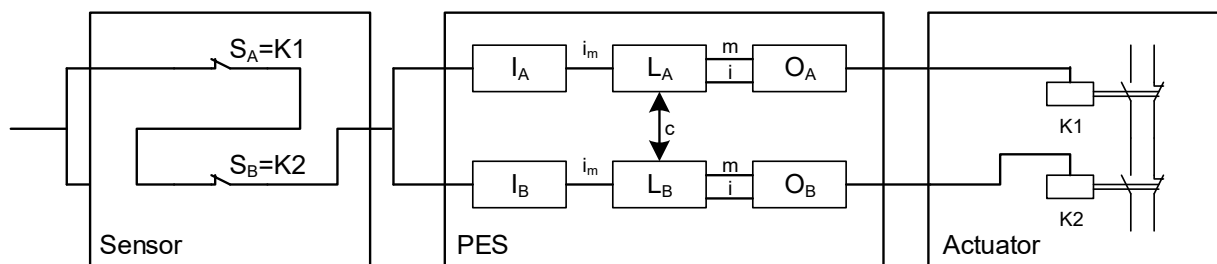

Fig. 14: Digital sensor 2-channel serial

Two-channel input element in serial connection (cat. 4, fault tolerance 1) with low to medium DC due to signal processing in two channels and diagnostics by means of cyclical testing.

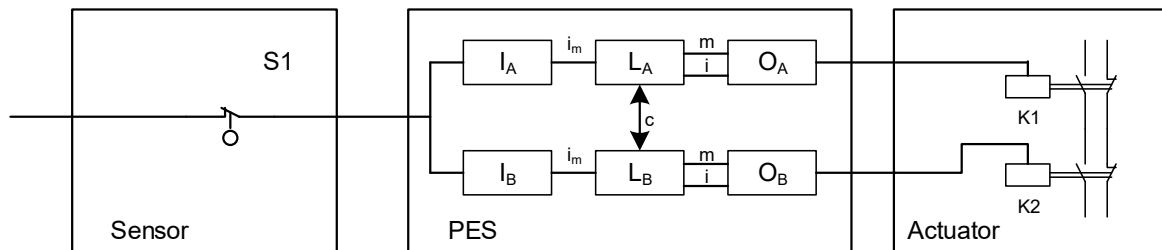

Fig. 15: digital sensor one-channel

One-channel input element and two-channel processing at low to medium DC due to two-channel signal processing and diagnostics by means of cyclical testing. PL / SIL dependent on permissible fault exclusions and on the test rate of input element.

10.2.1.2. DC of digital sensors / inputs

The SCU modules ensure far reaching diagnostics functions for the input element. These are carried out permanently or optionally (cross-shortening monitoring by means of pulse identifier, cross comparison, 2- or multi-channel sensor with/without time-out, start-up test).

Permanently active diagnostics functions:

Cross comparison:

The SCU modules inputs are in general internally designed with two channels. The status of input signals is permanently compared crosswise. Only with High signals in both partial input systems the input is considered a High input, should the signal level deviate between both channels, the input is set to Low state.

Dynamic test of the partial input system switching thresholds:

The switching thresholds for the detecting the High level are tested cyclically with a high cycle rate. Falling below the defined threshold value a module triggers a module alarm.

Dynamic test of the input system's switchability:

The switchability of the input system to Low level is tested for all inputs with a high rate. Falling below the defined threshold value a module triggers a module alarm.

Diagnostics functions that can be enabled by parametrization:**Cross circuit test:**

The SCU modules have clock signal outputs, identified by an unambiguous signature. When performing the cross-shortening test the switching elements of the digital sensors / input elements are supplied with auxiliary voltage by the SCU unit via the clock signal outputs. The signature is thus stamped on the High signal level of the sensors / input elements and checked by the SCU assembly. With the signature test short-circuits and cross-shortening to High signals can be recognized. With alternating use of the pulse signals of multi-contacts, parallel signal lines or adjacent terminal assignment, cross-shortening between the respective input elements is detected.

Sensors / input elements with 2- or multipole contacts without time-out:

Several contacts can be assigned to the sensors / input elements. These are therefore compatible with at least 2-channel elements. A High level of the sensor/input element requires a logic series connection of both contacts.

Example 1:

Input element with 2 normally open contacts: High level when both contacts are closed

Example 2:

Input element with one normally open contact and one normally closed contact: High level when normally closed contact is actuated and normally open contact is not actuated.

Sensors / input elements with 2- or multipole contacts with time-out:

Same test as before, but additional monitoring of the input signals for compliance with the defined level connections within a time window of 0.5 seconds. Defining the levels over a time period of > 0.5 seconds triggers a module alarm.

Start-up test:

Each time the safety module (=SCU module) is switched on, the input element must be tested in direction of the Low signal status (defined Safe State), e.g. by actuating the Emergency Stop button or a door lock after the system has been started.

Operational tests / organizational tests:

Apart from the previously mentioned diagnostic measures for the SCU modules, cyclic testing can be performed within the application. These tests can also be used when assessing the DC.

NOTICE

Operational/organizational tests can also be used for a combination of hardware inputs and functional inputs (input information transferred via standard field bus). However, an exclusive use of functional inputs is ruled out in this context (combination of two or more functional inputs).

The SCU modules therefore ensure far reaching diagnostics functions for the partial input system. These are performed permanently or optionally (cross-shortening monitoring by means of pulse identifier).

The following diagnoses for input sensors can generally be used for the safety related assessment of the entire system:

Input element characteristic	Parameterized / operational tests				DC	Definition of measure	Note
	Cross-shorting test	With time-out	Start test	Cyclic Test during operation			
Single-channel			O	O	>60	Cyclic test pulse by dynamic change of input signals	A sufficiently high test rate must be ensured.
	X				90	Cyclic test pulse by dynamic change of input signals	Only effective if pulse assignment is active
	X		O	O	90-99	Cyclic test pulse by dynamic change of input signals	DC depending on frequency of start / cyclic test DC = 90 test only in > 4 week intervals DC = 99 test at least 1 x day / or 100-time request rate
Dual-channel					90	Cross-comparison of input signals with dynamic test, if short-circuits cannot be detected (for multiple inputs/outputs)	For fault exclusion short-circuit up to DC=99 possible
			O	O	90-99	Cyclic test pulse by dynamic change of input signals	DC depending on frequency of start / cyclic test
	X				99	Cross-comparison of input signals with immediate and intermediate results in the logic (L) and temporal as well as logic program sequence monitoring and detection of static failures and short circuits (for multiple inputs/outputs).	Only effective if pulse assignment is active

		X			99	Plausibility test, e.g. use of normally open and normally closed contacts = non-equivalent signal comparison of input elements.	Only effective in connection with activated time-out function for input element
--	--	---	--	--	----	---	---

SAFETY NOTE

- The manufacturer's data (MTTFD, FIT-numbers, etc.) must be used for a safety related assessment of the partial system "Sensors".
- The DC-values listed in the table must be used conservatively and compliance with the boundary conditions (see table under „Remarks“) must be ensured.
- According to the applicable standards, fault exclusions are permitted. The boundary conditions mentioned in this context must permanently be met.
- If several sensor systems are required for the correct function of a single safety function, their partial values must be correctly merged by following the chosen method.

10.2.1.3. Classification of digital inputs

10.2.1.3.1. Digital inputs I00 ... I13

Device type	Digital inputs	Achievable performance level	Comment
SCU-x-EC, SIO-x	I00 ... I13	PL e	Suitable for any kind of input elements, with / without pulse, achievable PL depending on the $MTTF_d$ of the input element, as well as fault exclusions in the external wiring.
SDU-x	I00 ... I03 I08 ... I13	PL e	Suitable for any kind of input elements, with / without pulse, achievable PL depending on the $MTTF_d$ of the input element, as well as fault exclusions in the external wiring.
	I04 ... I07	PL e	Single-channel with pulse: <ul style="list-style-type: none"> - Mainly High level required ($T_{High} > 100 * T_{Low}$) - At least one request/day required by application - Fault detection upon request
		PL d	Single-channel without pulse: <ul style="list-style-type: none"> - Fault exclusion short-circuit between signals and to VCC - Fault detection upon request
		PL e	Dual channel: <ul style="list-style-type: none"> - At least one request/day required by application - Fault detection upon request

10.2.1.3.2. Digital inputs I/Os (IQIx)

Digital inputs	Achievable performance level	Comment
IQIx		Without pulse, single channel static signal -> auxiliary input
	PL e	Without pulse, dual channel static signal - At least one request/day required by application - Fault detection only upon request
	PL d	Without pulse, dual channel static signal - Less than one request/day required by application
	PL e	Single-channel with pulse - Mainly High level required ($T_{High} > 100 * T_{Low}$) - At least one request/day required by application - Fault detection only upon request
	PL d	Single-channel with pulse - Less than one request/day
	PL e	Dual channel with clock output 1 (T1) and clock output 2 (T2)

NOTICE

The achievable PI for a combination of HW-inputs and functional inputs depends on the chosen operational/organizational tests as well as on the independence of both channels in the system structure. The determination of the PL requires an application related analysis.

10.2.1.4. Exemplary connections of digital sensors

10.2.1.4.1. Single-channel sensor, without cross-shorting test

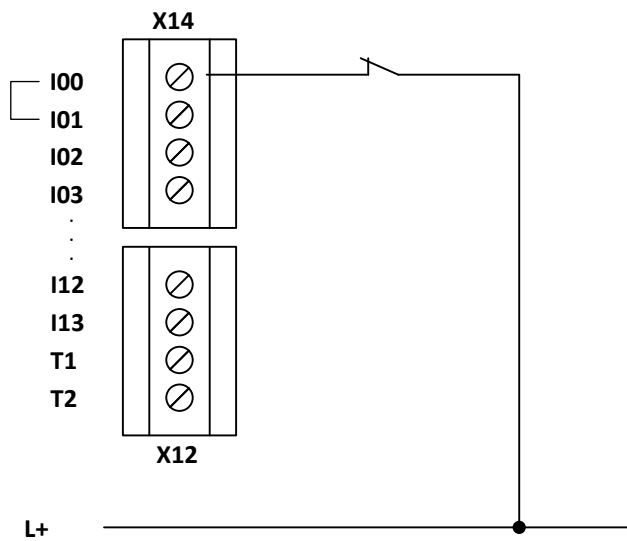

Fig. 16: Single-Channel sensor, without cross-shorting test

The single-channel sensor is connected to the SCU module without clocking or without cross-shorting test. This design is not recommended for safety applications. PL b acc. to EN ISO 13849-1 can maximally be reached.

10.2.1.4.2. Single-channel sensor with cross-shorting test

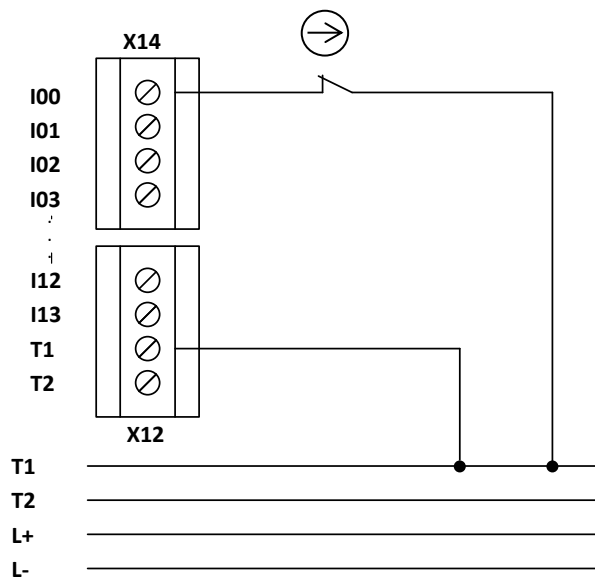

Fig. 17: Single-channel sensor with cross-shorting test

When using a single-channel sensor with clocking, the power supply of the switching element is attached to the clock output T1 or T2. The clock must subsequently be assigned to the SCU.

The use of a single-channel sensor with clock detects:

short-circuit to supply voltage DC 24 V
 short-circuit to DC 0 V
 cable interruption (current interruption is safe state!)

However, be cautious in case of a cable short between the two sensor connections, because this is not detected! A short-circuit between T1 and I00.

Due to the single-channel character of the switching element / sensor its failure requires a fault exclusion. This is permissible when using positively disconnecting switches with correct constrained actuation.

A series connection of 2 switching elements with corresponding fault exclusion of a double fault is on equal footing with the application (Occurrence of two errors at the same time.

These may be e.g. the safety outputs of an electronic monitoring device (light curtain, switching mat) with internal dual-channel switch-off.

PL d acc. to EN ISO 13849-1 can be achieved by using a suitable switching element and with cautious wiring of the sensor. In special cases, i.e. in connection with suitable switching elements and permissible fault exclusions one may also achieve PL e as per EN ISO 13849-1.

SAFETY NOTE



- PL e or higher acc. to EN ISO 13849-1 is achieved if the short-circuit between input and associated pulse output as well as the short-circuit between the sensor connections can be excluded. Here one must take care that in a fault scenario the switch must be positively opening in accordance with EN 60947-5-1. The sensor must additionally be triggered in regular intervals and the safety function requested. Fault exclusions can be achieved in accordance with EN ISO 13849-2 table D8. In case of single-channel use of the inputs, the achievable safety level must be limited to SIL 2 or PL d, if the safety function is demanded at regular intervals.
 - A series connection of 2 switching elements with fault exclusion for double fault requires testing of the suitability in accordance with the intended safety level of this element. We would like to draw your attention to the applicable regulations in the EC machine directive 2006/42/EC.
 - For single-channel sensors a safety related use of the inputs is only intended in connection with the clock outputs.
-

10.2.1.4.3. Dual-channel sensor without time-out and without cross-shorting

Faults are at least detected when requested. The DC is medium and by using cyclic tests (start test, operational/organizational tests) can be changed up to high level. depending on the test frequency.

Only normally closed contacts should be used for safety related applications.

PL d acc. to EN 13849-1 can be achieved when using sensors / switching elements with fault exclusion for not opening the switch contacts. This is permissible when using positively disconnecting switches with correct constrained actuation. The use of sensors with self-monitoring output contacts is also permitted.

PL e in accordance with EN ISO 13849-1 can be achieved when using sensors / input elements with sufficiently high $MTTF_d$ in connection with temporal plausibility monitoring and a sufficiently high change of the switching state = dynamic testing.

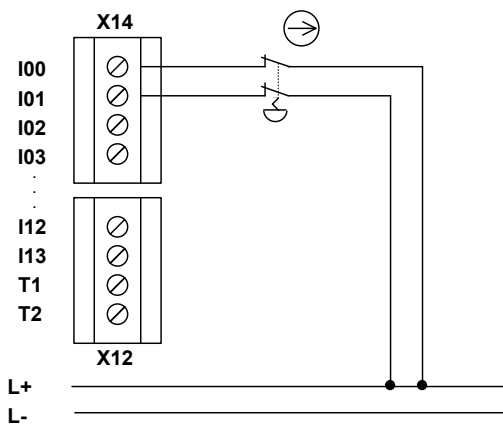

Fig. 18: dual-channel sensor homogenous without cycling, with positive disconnection

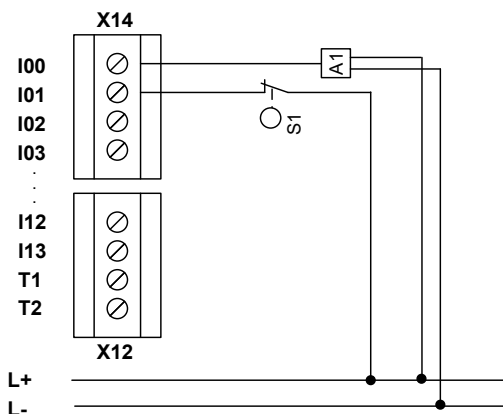

Fig. 19: dual-channel input element heterogeneous, without cycling

SAFETY NOTE

- PL d or higher in accordance with EN ISO 13849-1 is achieved by using switching elements / sensors with positively opening contacts or positive actuation acc. to EN 60947-5-1
- Using devices for which the fault exclusion double fault for the intended safety level can be specified for the switching elements, is permitted. We would like to draw your attention to the applicable regulations in the EC machine directive 2006/42/EC.

10.2.1.4.4. Dual-channel sensor with time-out and cross-shorting test

Cross-shorting as well as connections to DC 24 V and DC 0 V can be detected by using two independent clock signals on the homogeneous sensor.

PL d or higher acc. to EN ISO 13849-1 can be achieved when:

- Use of sensors/switching elements with forced actuation.
- Use of 2 sensors/switching elements with independent manipulation
- dto. However, with actuation via a common actuation device in connection with an error exclusion for this device.

Fig. 20 dual-channel sensor homogenous with clock

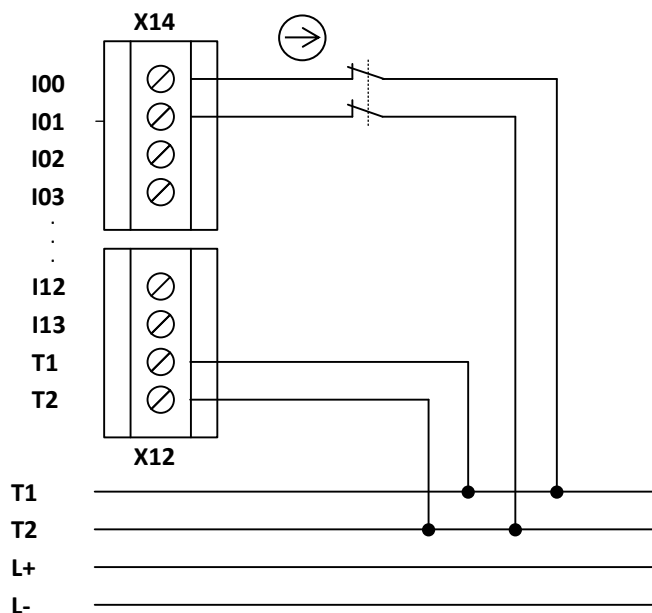
SAFETY NOTE

- PL d or higher in accordance with EN ISO 13849-1 is achieved by using switching elements / sensors with positively actuation
- When using two independent sensors with independent actuation, PL d or higher acc. to EN ISO 13849-1 can be achieved.
- When using common elements in the actuation chain, a fault exclusion is required for this purpose. The corresponding limitations and criteria acc. to EN 13849-1 must be observed

10.2.1.5. Overview of achievable PL for digital safety inputs

Type of Sensor / input element	Input	Parameterized / operational tests				Achievable PL acc. to EN ISO 13849-1	Fault exclusion for input element	Condition for input element
		Cross-connection	With time monitoring	Start test	Cyclic test during operation			
Single-channel	I00..I13					b		Operation proven input element
					O	d	All faults at the input element Short-circuit at input/signal line	MTTF _D = high Connection in control cabinet or protected routing
						e		
	SDUx I00..I03 I08..I13					e	All faults at the input element Short-circuit at input/signal line	Input element does not comply with min. PL r Connection in control cabinet or protected routing
	SCUx I00 – I13							
	all					d	Getting caught Short-circuit at input/signal line	Mainly High level required (T _{High} > 100 * T _{Low}). Positively disconnecting MTTF _D = high Connection in control cabinet or protected routing
					O	e	All faults at the input element Short-circuit at input/signal line	Input element does not comply with min. PL r Connection in control cabinet or protected routing MTTF _D = high
	Dual-channel parallel	all					d	Short-circuit between input/signal line
						e		MTTF _D = high

Dual-channel parallel	all		X			e	Short-circuit between input/signal line (only with common switching elements = 2xNO or 2xNC)	Connection in control cabinet or protected routing MTTF _D = high	
Dual-channel serial	SDUx I00..I03 I08..I13					d	Short-circuit at input/signal line Getting caught / positively disconnecting	Connection in control cabinet or protected routing MTTF _D = medium	
	SCUx I00 - I13				O	e	Short-circuit at input/signal line	Connection in control cabinet or protected routing MTTF _D = high	
	all					O	d	Short-circuit at input/signal line	Connection in control cabinet or protected routing MTTF _D = medium
						O	e		MTTF _D = high

X: Diagnostic measure activated

O: min. 1 diagnostic measure activated

10.2.2. Sensors for speed and/or position detection

10.2.2.1. General safety related structure of sensor interface for position and/or speed

The SDU-x modules of the SCU series are equipped with one (SDU-11), or two encoder interfaces (SDU-12/-22) per axis.

Depending on encoder type and combination, different safety levels can be reached. The following system reflection results for the corresponding partial system:

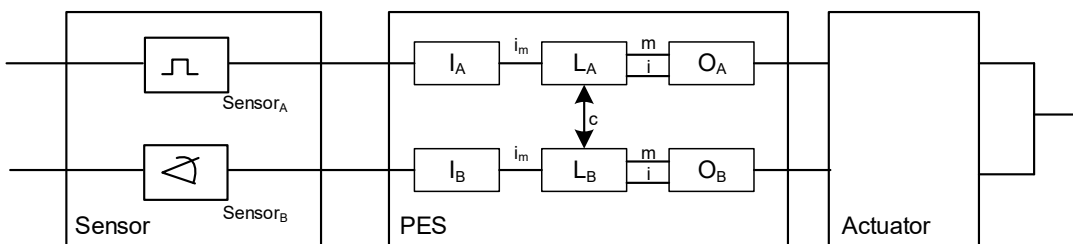

Fig. 21: dual-channel sensor system with separate signal processing

Dual sensor system with separate signal processing in two channels, diagnose by cross-comparison in the PES

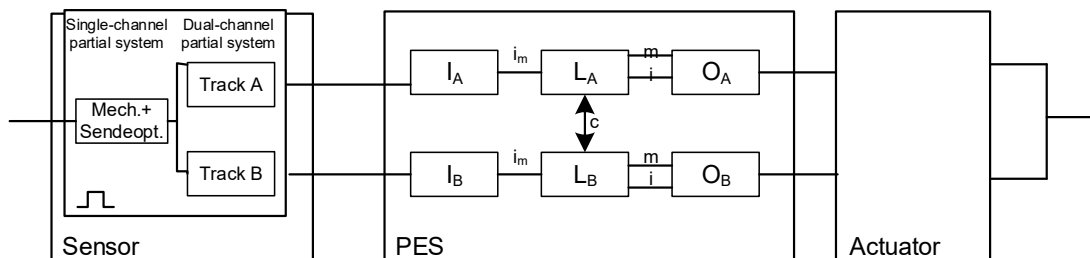

Fig. 22: Sensor system with single-/dual-channel partial system

Sensor system with single and dual-channel partial system (example incremental encoder). Diagnose by separate signal processing in two channels and cross-comparison in the PES as well as further specific diagnoses

10.2.2.2. General diagnostic measures for encoder interface

For fault detection in the sensor system the SCU series (SDU modules) has a number of diagnostic measures implemented, depending on the chosen encoder type or its combination. These are automatically activated when choosing the encoder type.

With respect to their type and effectiveness diagnostic measures can generally be classified using the following table:

Diagnoses for sensors for position and/or speed detection:

Measure	DC	Note	Use
Cross-comparison of input signals with immediate and intermediate results in the logic (L) and temporal as well as logic program sequence monitoring and detection of static failures and short circuits (for multiple inputs/outputs).	99%	Only to be used for: - dual-channel sensor systems (2 separate sensors), - the dual channel partial system of single channel sensors (incremental encoder) - Diagnose for the single and dual channel partial system of especially suitable sensor systems (SIN/COS-encoder, resolver) - Dynamic operation / no standstill monitoring	Monitoring of 2-channel sensor systems or the corresponding partial system of sensors for dynamic operation Not to be used for standstill monitoring!
Cross-comparison of input signals without dynamic test	80-95%	DC depends on the frequency of the dynamic condition, i.e. standstill or movement, as well as on the quality of the monitoring measure (80 – 90 % for incremental encoder, 95 % for SIN/COS-encoder)	Monitoring of 2-channel sensor systems or the corresponding partial system of sensors for non-dynamic operation To be used especially for standstill monitoring!
Monitoring of some features of the sensor (response time, the area of analog signals, e.g. electric resistance, capacity)	60%	Diagnose of specific features of sensors, only to be used for speed and position sensors as per chapter 4.2.2.4	Monitoring of the single-channel partial system in single-channel sensor systems

10.2.2.3. Encodertypen und deren Kombination, Diagnosekenndaten

Encoder A	Encoder B	Safe speed	Safe direction	Safe absolut Position	Fault exclusion	DC		
						1-channel partial system	2-channel partial system dynamic	2-channel partial system non-dynamic (standstill-monitoring)
1 x Proxi	1 x Proxi	X			Operating Actuator ***)	n.a.	99%	80-90%
Incremental	NC	X			Mech. Encoder connection*) Code disk mounting **)	60%	99%	80-90%
Incremental	Incremental	X	X			n.a.	99%	95%
Incremental	1 x Proxi	X				n.a.	99%	90-95%
Incremental	2 x counter Proxi 90°	X	X			n.a.	99%	90-95%
Incremental	SIN/COS	X	X			n.a.	99%	99%
Incremental	HTL	X	X			n.a.	99%	90-95%
Incremental	Resolver	X	X			n.a.	99%	99%
Incremental	SSI	X	X	X		n.a.	99%	90-95%
SIN/COS	NC	X	X		Mech. Encoder connection*) Code disk mounting **)	60% / 90%*) **)	99%	90-95%
SIN/COS	Incremental	X	X			n.a.	99%	95-99%
SIN/COS	1 x Proxi	X	X			n.a.	99%	90-95%
SIN/COS	2 x counter Proxi 90°	X	X			n.a.	99%	95-99%
SIN/COS	HTL	X	X			n.a.	99%	95-99%

Encoder A	Encoder B	Safe speed	Safe direction	Safe absolut Position	Fault exclusion	DC		
						1-channel partial system	2-channel partial system dynamic	2-channel partial system non-dynamic (standstill-monitoring)
SIN/COS	Resolver	X	X			n.a.	99%	99%
SIN/COS	SSI	X	X	X		n.a.	99%	95-99%
SSI	2 x counter Proxi 90°	X	X	X		n.a.	99%	90-95%
SSI	SIN/COS	X	X	X		n.a.	99%	95-99%
SSI	Resolver	X	X	X		n.a.	99%	95-99%
SSI	SSI	X	X	X		n.a.	99%	90-95%
NC	SIN/COS	X	X		Mech. Encoder connection*) Code disk mounting **)	60% / 90% *) **)	99%	90-95%
NC	Resolver	X	X		Mech. Encoder connection*) Code disk mounting **)	60 / 90% *) **)	99%	90-95%
NC	HTL	X			Mech. Encoder connection*) Code disk mounting **)	60%	99%	80-90%
2 x counter Proxi 90°	SSI	X	X	X		n.a.	99%	90-95%
SSI	Fieldbus (ECAT, etc.)	X	X	X		n.a.	99%	90-95%

*) For the mechanical connection, a fault exclusion can be made with the note "... only positive connections are permissible for the shaft-hub connection of the encoder axis"; alternatively, other connection forms can also be used if they meet the safety requirements. For their reliability with regard to the intended safety level, comprehensible proof must be provided in each case (e.g.: overdimensioning for positive shaft-hub connection). The corresponding notes on fault exclusion in standard EN/IEC 61800-5-2, Annex D.3.16 (Table D.8) must be observed."

For SINCOS encoders suitable for safety applications (see notes on this under...), a DC of 90% can be applied for the single-channel transmit LED.

***) The connection code disc / shaft as well as the sensor embodiment must be analyzed in detail. For a possible fault exclusion, the relevant notes in the standard EN/IEC 61800-5-2, Annex D.3.16 (Table D.8) must be observed.

***)) For speed measurement by means of Proxi, the actuator and the mounting of the Proxi shall be analyzed with regard to their reliability. For a possible fault exclusion, the relevant notes in the standard EN/IEC 61800-5-2, Annex D.3.16 (Table D.8) shall be applied mutatis mutandis.

Other single-channel parts for which the 60% apply:

Power supply

Code disk mounting

Opto-receiver mechanics (not SINCOS)

Code disk

10.2.2.4. Specific diagnostic measures with regard to the encoder type used

Encoder type	Supply voltage monitoring	Difference level monitoring	SIN/COS plausibility monitoring	Signal level input monitoring	Monitoring of the permissible quadrants	Monitoring of the counting signal separated for track A/B	Monitoring of the transfer ratio reference signal / measured signal	Frequency monitoring of the reference signal	Voltage monitoring of the reference signal	Form factor analysis of the measured signal	Plausibility test position signal versus speed	Monitoring of Clk-frequency	Encoder interface specific diagnoses
Interface X 31/32, X23	Incremental	X	X			X							
	SIN/COS	X		X									
	SSI	X	X										
	Proxi 2 x counting input	X											
	Proxi 1 x counting input	X											
Interface X 33/34	Incremental	X	X		X	X							
	HTL		X		X								
	Resolver			X	X		X	X	X	X			
	SIN/COS	X		X	X ¹⁾								
	SSI	X	X								X	X	
Interface ENC 1.5	PXV	X ²⁾									X	X ²⁾	

¹⁾ Only in High-Resolution Mode

²⁾ measures for encoder interface Safe PXV:

- Checking the transmission of the safe position via CRC32
- Analysis and evaluation of the error bits of the encoder
- Plausibility check of the code band by dynamic color switching



More information is available TS-37000-410-01-810-xxF-SMX-x-PXV installation manual

10.2.2.5. Safety-related switch-off threshold encoder systems for position and speed detection

Plausibility tests with the current position and speed values are performed between both measuring channels A and B of the SCU module as a basic measure, which are then checked against parameterizable thresholds.

The **incremental shut-down threshold** describes the tolerable deviation of position between both sensing channels A and B in the unit of the measuring distance.

The **speed shut-down threshold** describes the tolerable deviation in speed between both sensing channels A and B.

Diagnostic functions for the determination of optimal parameter values for the applications are available within the SCOPE-dialog of the parameterization tool.

NOTE Speed and acceleration are detected values with a minimal digital resolution.
This fact limits the smallest possible detection of speed or acceleration and determines the digital step width for the input values.

Speed resolution:

Up to a frequency of 500 Hz or 500 steps/s speed is detected with the frequency measuring method, below this it is measured with a time measuring method. This results in the following course of the sensing fault:

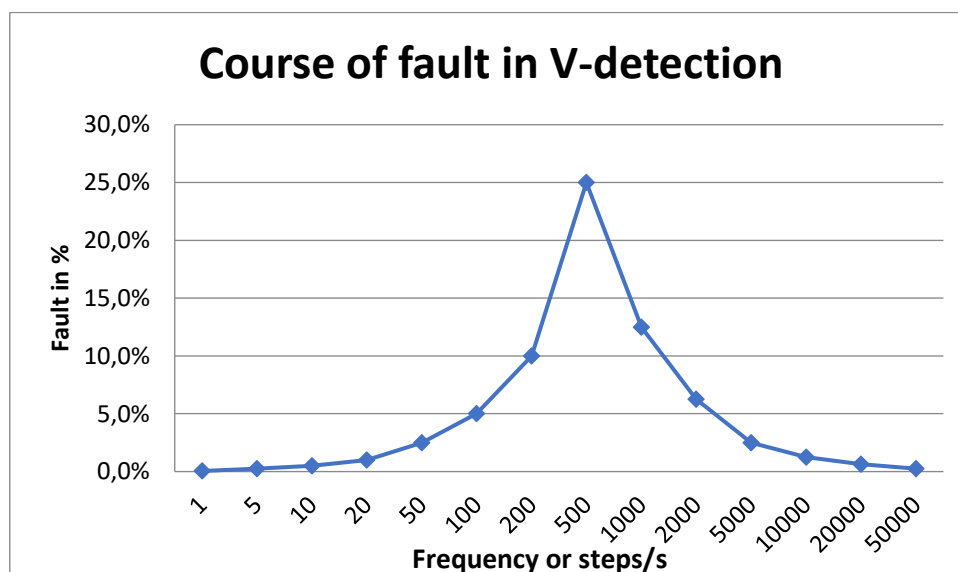
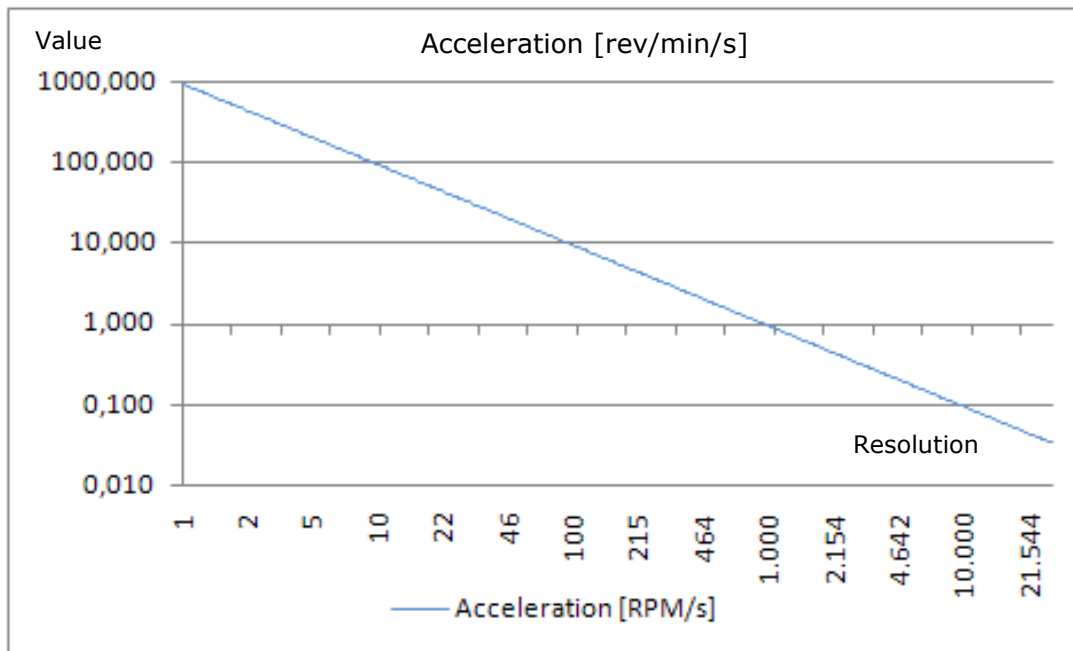

Fig. 23 Course of fault in V-detection

Digital acceleration resolution

The digital acceleration resolution is limited by a maximum peak time of 256 ms and the encoder resolution. The graphs below show the lowest measurable acceleration in dependence on the resolution in revolutions/min, mm/s² and m/s².



Graph acceleration, rotary (Values in rev/min/s)

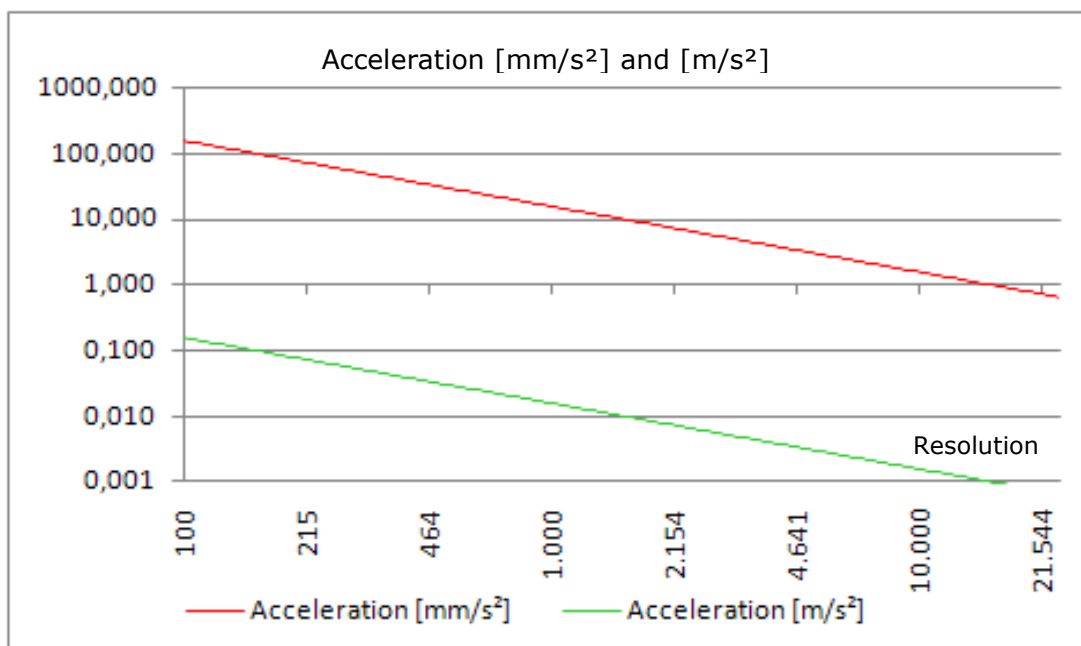

Graph acceleration, linear (values in mm/s and m/s²)

SAFETY NOTE

- The fault can be optimized by choosing a suitable sensor resolution for the corresponding application.
- For applications with limited resolution and/or time variance of the sensing signal, the functional performance of the monitoring function used can be improved by using an average filter. The average filter "smoothes" digital spurious components of the sensors. However, this is achieved at the cost of a longer response time of the overall system.
- The filter time can be variably set between 0 and 64 in steps of 8. The dimension is "msec". In order to determine the response time of the overall system, the filter times must be added to the specified response times of the SCU system (see chapter 9).

SAFETY NOTE

- The manufacturer's data (MTTF_D, FIT-numbers, etc.) must be used for a safety related assessment of the partial system "Sensors".
- If the manufacturer demands specific diagnoses to be able to guarantee the specified safety related characteristic values, these must be checked with respect to the specific encoder as specified in the table "Specific diagnostic measures for position and speed sensors". If in doubt, the matter must be clarified by the manufacturer.
- The DC-values listed in the table must be used conservatively and compliance with the boundary conditions (see table under „Remarks“) must be ensured.
- In order to determine the DC-value for safety functions with standstill monitoring a frequency assessment of the dynamic status may be required. A DC of 90 % may here be used as a guide value.
- According to the applicable standards, fault exclusions are permitted. The boundary conditions mentioned in this context must permanently be met.
- If several sensor systems are required for the correct function of a single safety function, their partial values must be correctly merged by following the chosen method. This applies also for a combination of digital and analog sensors (e.g. safely reduced speed with open safety door = door contact + encoder for speed detection)
- By choosing a suitable resolution of the sensor system a sufficiently low tolerance with regard to the corresponding cut-off thresholds for the individual safety functions must be ensured.
- When using the encoder input filter, one must consider the extension of the response time when assessing the safety related function.

10.2.2.6. Safety-related evaluation of encoder systems, resolvers or their combination

Due to the monitoring functions implemented in the SCU-series, no special demands are initially made on the internal design of the encoder electronics in applications with encoder systems, i.e. standard encoders can normally be used.

A safety related assessment of the overall arrangement must generally be made. Data issued by the encoder manufacturer (FIT, MTTF) as well as the DC from the table in chapter 10.2.2.2 "General diagnostic measures for encoder interface" must in this case be used.

When using individual encoders at least a fault exclusion for the mechanical actuating chain, as well as for the single-channel part of must be made under due consideration of the applicable specification in EN ISO 13849-1. Furthermore, the information in "10.2.2 Sensors for speed and/or position detection" must also be observed.

PL d and higher acc. to EN ISO13849-1 is normally reached by a combination of two encoders with prioritized different technology and separated mechanical linking.

The use of compact encoders with internal 2-channel structure of different technology is also suitable for applications up to PL e acc. to EN 13849-1, however, under due consideration of the specifically required fault exclusions and their permissibility. Normally one should use encoders with proven safety related characteristics, the safety level of which meets the demanded level.

SAFETY NOTE



- ➔ They use of standard encoders or a combination of standard encoders is permitted. A safety-related evaluation is strictly required for the overall arrangement consisting of encoders, sensors/switching elements for triggering the safety function, the SDU module and the shutdown channel. To determine the safety level achieved, the manufacturer's specifications (FIT, MTTF) and the DC must be used in accordance with the requirements in "10.2.2 "
- ➔ If only one encoder is used, the fault exclusion "shaft breakage / fault in the mechanical encoder connection" is required. Suitable measures must be applied for this purpose, e.g. a positive connection of the encoder by means of slot shim or locking pin. The applicable information issued by the manufacturer as well as EN ISO 138549-1 with respect to requirements and permissibility of the fault exclusion must strictly be followed.
- ➔ Encoders with proven safety related characteristics must preferably be used as individual encoders. The safety level of these encoders must at least meet the intended safety level of the overall arrangement. The information of the manufacturer with respect to diagnostic measures, mechanical connection and measures for the voltage supply must be strictly followed.

-
- ➔ SIN/COS encoder: The internal structure of the sensor system must be designed in such a way, that output signals for both tracks can be generated independently from each other and Common-Cause faults can be ruled out. Evidence of the mechanical design, e.g. fastening of the code disc on the shaft, must also be provided. Encoders with proven safety related characteristics should preferably be used.
 - ➔ When using compact encoders with internal dual-channel structure, such as e.g. SSI + incremental/SinCos, you must strictly follow the instructions of the manufacturer concerning safety related characteristics, diagnostic measures, mechanical connection and measures concerning the electric power supply. The safety level of the encoder must at least meet the intended safety level of the overall arrangement. Encoders with proven safety related characteristics should preferably be used.
-

The SCU- module generally detects the following faults in the external encoder system:

- Short-circuits between safety relevant signal lines
- Interruptions in safety relevant signal lines
- Stuck at 0 or 1 on one or all safety relevant signal lines

Each encoder type has further specific diagnoses for fault detection in the external encoder system assigned. The following list shows the respective diagnostic measures for the individual encoders, together with the limiting parameters.

SAFETY NOTE



- The diagnostic measures obviously have tolerances because of measuring inaccuracies. These tolerances must be accounted for in the safety related assessment.
 - The limiting values for the corresponding diagnostic measures are partly parametrizable or fixed. The diagnostic coverages resulting from this must be assessed in relation to the application and included in the safety related overall assessment.
-

10.2.3. Analog sensors

The FSoE Slave-modules SDU-21A and SDU-22A have two analog inputs with two input channels each. Only 2-channel sensors can generally be connected to this interface.

The internal signal processing takes place separately in the two channels with cross-comparison of the results.

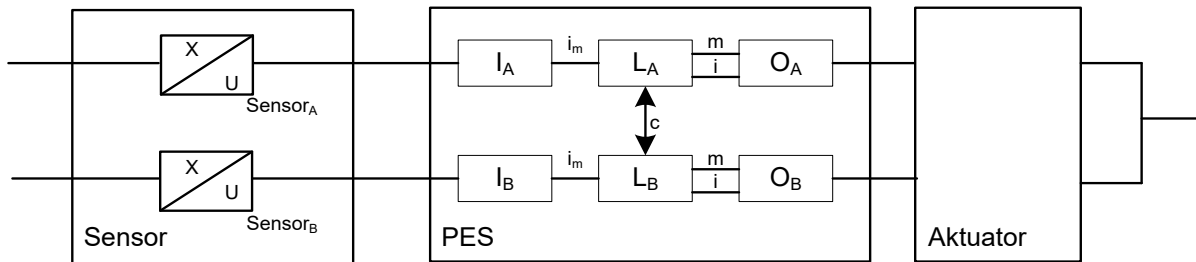

Dual-channel sensor system with separate signal processing in two channels, diagnose by cross-comparison in the PES

As with other sensor systems, a vast number of diagnostic measures has been implemented.

With respect to their type and effectiveness diagnostic measures can generally be classified using the following table:

Diagnoses for sensors for position and/or speed detection

Measure	DC	Note	Use
Cross-comparison of input signals with dynamic test, if short-circuits cannot be detected (for multiple inputs/outputs)	90	Comparison of the analog input values with identical characteristics for both channels	Monitoring of dual-channel systems with identical characteristic of the input signals
Cross-comparison of input signals with immediate and intermediate results in the logic (L) and temporal as well as logic program sequence monitoring and detection of static failures and short circuits (for multiple inputs/outputs).	99	Comparison of the analog input values with diverse characteristic for both channels. E.g. inverse signal course, etc.	Monitoring of dual-channel systems with diverse characteristic of the input signals

SAFETY NOTE



- The manufacturer's data (MTTF_D, FIT-numbers, etc.) must be used for a safety related assessment of the partial system "Sensors".
- The DC-values listed in the table must be used conservatively and compliance with the boundary conditions (see table under „Remarks“) must be ensured.
- According to the applicable standards, fault exclusions are permitted. The boundary conditions mentioned in this context must permanently be met.
- If several sensor systems are required for the correct function of a single safety function, their partial values must be correctly merged by following the chosen method. This applies also for a combination of digital and analog sensors (e.g. safely reduced speed with open safety door = door contact + encoder for speed detection)

10.2.3.1. Exemplary connection of analog sensors

By using suitable sensors and careful wiring of the sensor PL e acc. to EN ISO 13849-1 can be achieved.

The analog current inputs are all equipped with the fixed loading resistor of 500 Ω. For analog voltage inputs this resistor is omitted.

10.2.3.1.1. Voltage and current sensor

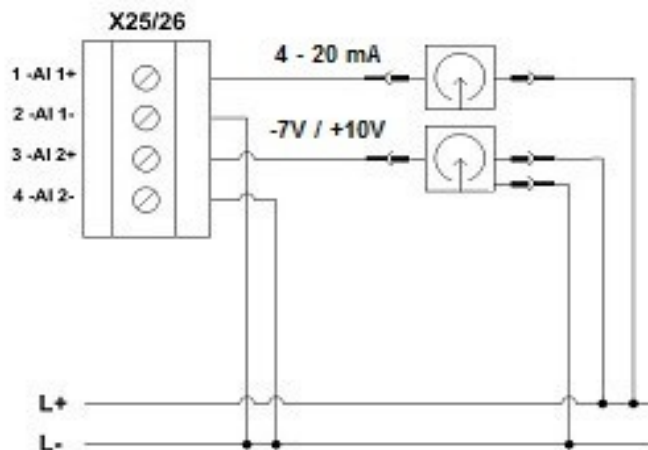

10.2.3.1.2. Voltage sensor with test pulse

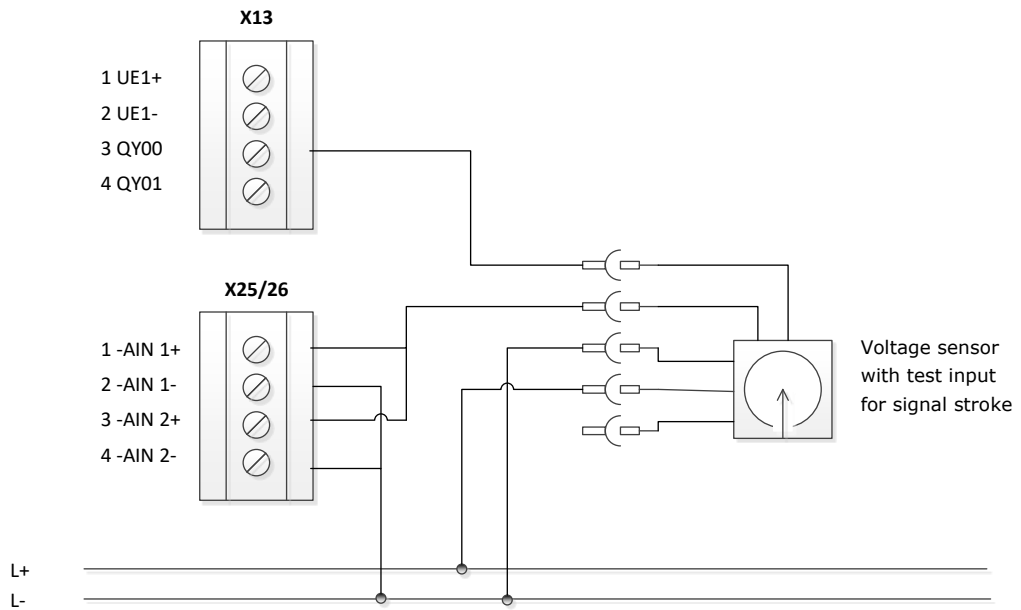

10.2.3.1.3. Current sensor with test pulse

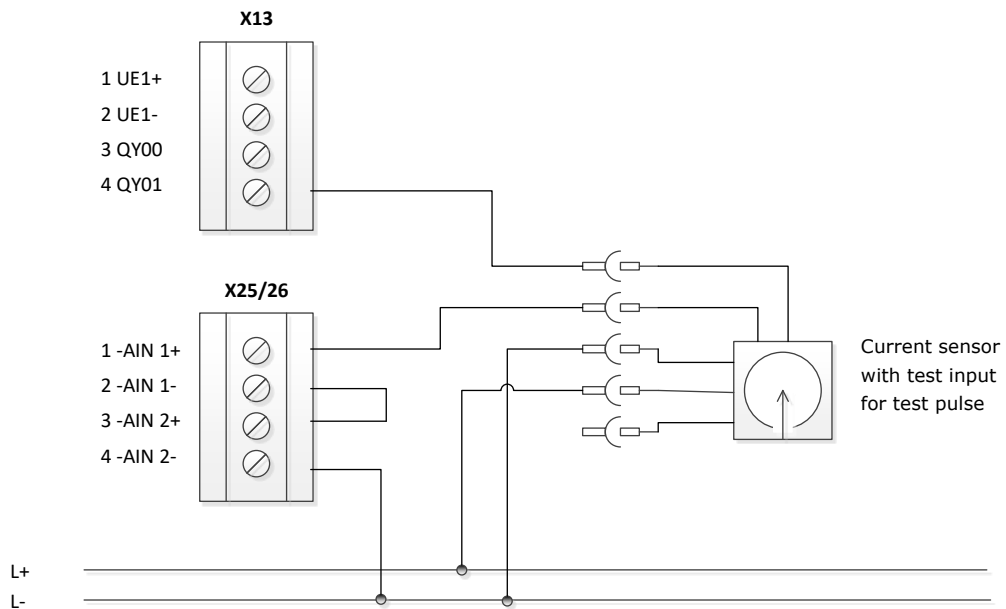

SAFETY NOTE

- PL e acc. to EN ISO 134849-1 is achieved when using two non-reactive sensors, for which Common Cause faults can be ruled out.



10.3. Safety related characteristic data and wiring of the outputs

The SCU/SDU-modules all have safe outputs of various types. For wiring, the corresponding characteristic as specified in the following description, must be accounted for.

10.3.1. Charakteristic of output elements

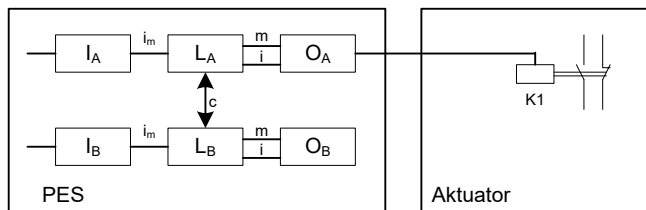

Single-channel output and single-channel actuator without diagnostics

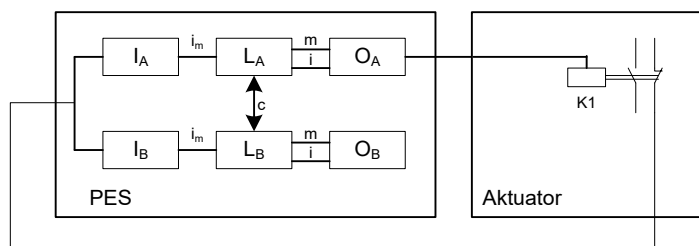

Single-channel output and single-channel actuator with diagnostic

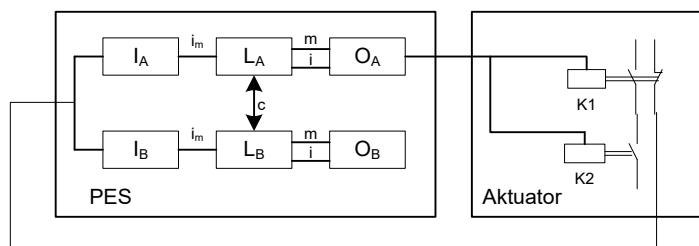

Single-channel output (Rel 1 / 2, DO 0/1P, DO 0/1M) and dual-channel actuator with at least single-channel diagnostic.

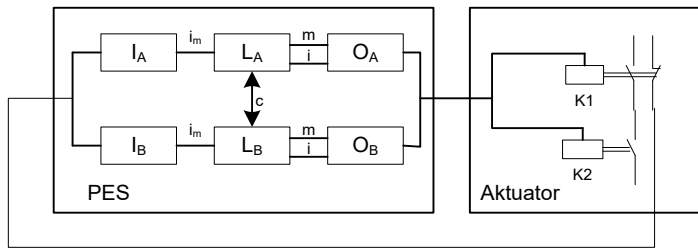

Single-channel output with internal dual-channel processing (IQx) and dual-channel actuator with at least single-channel diagnostic

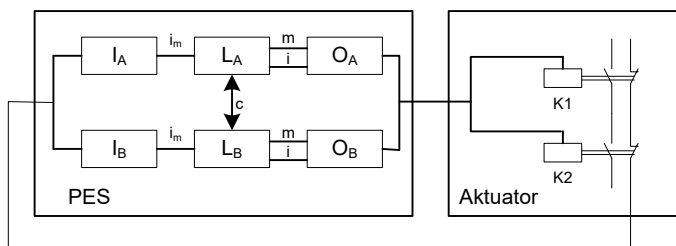

Single-channel output with internal dual-channel processing (IQx) and dual-channel actuator with dual-channel diagnostic

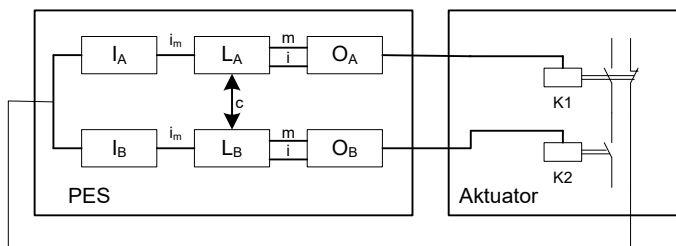

Dual-channel output and dual-channel actuator with single-channel diagnostic

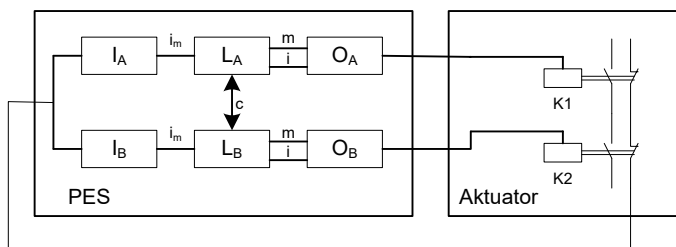

Dual-channel output and dual-channel actuator with dual-channel diagnostic

10.3.2. Diagnoses in the cut-off circuit

The cut-off circuit is equipped with durably implemented and parametrizable diagnostics functions. Certain diagnostics functions also include the external part of the cut-off channel. Depending on the use of these diagnostics functions, different DC-values will arise.

10.3.2.1. Diagnostic functions

Durably implemented diagnostics functions:

Cross-wise readback of outputs:

All safety outputs are read back in the complementary channel. Faults in the internal cutout circuit of the SCU/SDU module are thus detected with DC = High.

Test of cutout ability for QX03 and QR0 (only control of relay), QX00, QX01, QX02, QX03:

The cutout ability of these outputs is cyclically tested. Failure of the cutout possibility is clearly detected.

Parametrizable diagnostics functions:

Readback of the actuator status via auxiliary contacts, position indicators, etc.:

The current status of the actuator is detected by correspondingly suitable auxiliary contacts or position indicators and compared with the nominal status. Any deviation is thereby clearly recognized.

NOTICE

- The DC depends on a single-channel or dual-channel diagnose as well as on the switching frequency.
-

Testing the cutout ability for IQx, QX00 – QX03:

Once this function has been activated, the cutout ability of these outputs is cyclically tested. Failure of the cutout possibility is clearly detected.

10.3.2.2. Overview DC with respect to the chosen diagnostic functions

Measure	DC	Note	Use
Monitoring of outputs b a channel without dynamic test.	0-90%	DC depending on switching frequency When using elements for switching amplification (external relays or contactors) only effective in connection with the readback function of the switching contacts	Monitoring of electro-mechanical, pneumatic or hydraulic actuators / outputs
Redundant cutout path with monitoring one of the drive elements	90%	When using elements for switching amplification (external relays or contactors) only effective in connection with the readback function of the switching contacts	Monitoring of the outputs with direct functions as safety circuit or monitoring of safety circuits with elements for switching amplification of pneumatic / hydraulic control valves in connection with readback functions from their switching status
Cross-comparison of input signals with immediate and intermediate results in the logic (L) and temporal as well as logic program sequence monitoring and detection of static failures and short circuits (for multiple inputs/outputs).	99%	When using elements for switching amplification (external relays or contactors) only effective in connection with the readback function of the switching contacts For applications with frequent safety shut-down requests these tests should be performed more frequently, e.g. at the beginning of the shift, 1 x per week. However, a test should at least be carried out cyclically 1 x year.	Monitoring of the outputs with direct functions as safety circuit or monitoring of safety circuits with elements for switching amplification of pneumatic / hydraulic control valves in connection with readback functions from their switching status

10.3.3. Permissible capacitive and inductive load at safe outputs

The safe outputs of the SCU/SDU exhibit an OSSD character. That is, the outputs are cyclically switched off for the test of the switching off ability and the status is read back.

The examination of the switching off ability takes place according to the following criteria/functions:

- After switching the output off, the output voltage may max. be 5.6 V
- The permissible voltage level must be achieved at the latest after 400 μ s
- If the permissible voltage level is reached, the test is seen as successful, the output is activated again without further delay
- If the permissible voltage level is still not reached after 400 μ s, an alarm is triggered and all safe outputs (second channel with safe outputs!) are deactivated

The following representation shows the ideal (green curve) and typical (red curve).

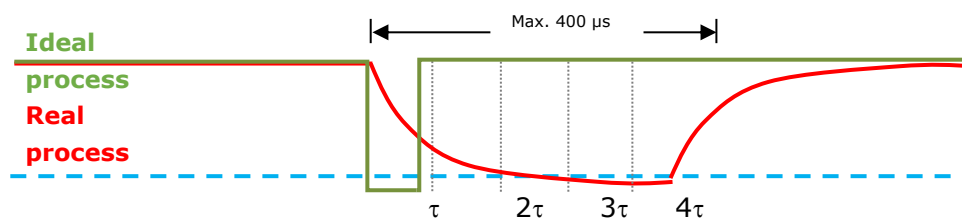

For the determination of the maximally permissible capacity or inductance, the time constant τ of the real RC or RL member at the output must be viewed.

This RC or RL member determines the real discharge curve:
The voltage level of max. 5.6 V is securely reached after 3 τ .

It thus applies:

$$3\tau \leq 350\mu\text{s}$$

$$\tau \leq 100\mu\text{s}$$

With that connection:

$$\tau = RC = \frac{L}{R}$$

the max. usable capacitive or inductive load can be determined in connection its Ohm's load:

$$C_{\max} = \frac{\tau}{R} = \frac{10^{-4}}{R}$$

or

$$L_{\max} = \tau R = 10^{-4} \cdot R$$

Typical values for the capacity C are C=20 nF and for longitudinal inductance L = 100 mH

10.3.4. Digital outputs

The modules

- SCU-1-EC/x, SCU-2-EC/x
- SDU-11-x, SDU-12, SDU21/21A, SDU-22/22A, SIO-1, SIO-2

all have basic outputs of identical design.

10.3.4.1. Characteristic data of the basic outputs

The SCU Series provides different types of outputs which can be interconnected individually or in groups.

output	Architecture acc. to EN ISO 13849-1	Comment
Combination of 2 relays QR0 – QR1	4	Complete tripping channel in compliance with architecture category 4 acc. to EN ISO 13849-1
QR0, QR1	Non safe	Only functional
QX00_PP and QX01_PN	4	Complete tripping channel in compliance with architecture category 4 acc. to EN ISO 13849-1
QX00_PP	Non safe	Only functional
QX01_PN	Non safe	Only functional
QX02_PP and QX03_PN	4	Complete tripping channel in compliance with architecture category 4 acc. to EN ISO 13849-1
QX02_PP	Non safe	Only functional
QX03_PN	Non safe	Only functional
QX00 – QX03	4	Complete tripping channel in compliance with architecture category 4 acc. to EN ISO 13849-1
T1	Non safe	Auxiliary output
T2	Non safe	Auxiliary output

The QXx_PP, QXx_PN and QX00 – QX03 outputs are subjected to a plausibility test in all operating states. In switched on state the correct function of all outputs is tested with a cyclic test pulse. For this purpose, the output is switched to the corresponding inverse value for a test period $TT < 500\mu s$ (typically $200\mu s$) i.e. one pp-output is switched instantaneously to 0 VDC potential, while one pn-output is switched to 24 VDC potential.

The relay outputs QR0, QR1 are monitored for plausibility during each switching cycle. The relay outputs must be switched cyclically and thus tested to maintain the safety function. The switching/test cycle is determined in dependence on the application.

SAFETY NOTE



- For applications with frequent safety shut-down requests these tests should be performed more frequently, e.g. at the beginning of the shift, 1 x per week. However, a test should at least be carried out cyclically 1 x year.
- The test function for the outputs is performed for groupes and individual controls. The auxiliary outputs are not tested
- **The High-Side (Qx_PP) and Low-Side (Qx_PN) outputs must individually not be used for safety duties. Any use for safety duties is only permitted for High-Side / Low-Side combination (Note: not relevant from FW release 05-00-00-01)**
- A mixed operation with the relay contacts is **not** permitted!

Mixed operation: A dangerous contact voltage potential may not be mixed with a protective low voltage.

Example:

FALSE: 230 V AC (120 VAC cULus) are switched over QR0L + QR0 and 24 V DC are switchable over QR1L+ QR1

*TRUE: 230 VAC (120 VAC cULus) are switched over QR0L + QR0 and over QR1L+ QR1 respectively.
Or 24 V DC are respectively switched over QR0L + QR0 and QR1L+ QR1.*

The outputs can be loaded as follows:

Output	Voltage	Current
Relay QXx	DC 24 V	2,0 A (DC 13, pilot duty)
Relay QXx	AC 230 V	2,0 A (AC 15)
	DC 120 V	2,0 A (pilot duty)
Tx	DC 24 V	250 mA
QXx_PP	DC 24 V	2 A
QXx_PN	GNDEXT	2 A
Qx	DC 24 V	0,5 A, 2 A

10.3.4.2. Wiring examples basic outputs

10.3.4.2.1. Single-channel switching relay or semi-conductor output without test

For the connection of multi-phase applications or for higher current demands external contactors may be used. For a single-pole connection without external test please bear in mind that the SCU/SDU module will not recognize bonding of one or several external contacts. The following circuit example is only limited suitable for safety applications, PL b acc. to EN ISO 13849-1 can maximally be achieved!

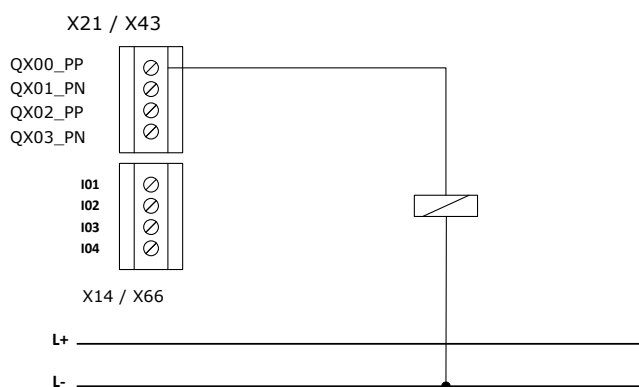

Fig. 24: Single-channel switching P-output.

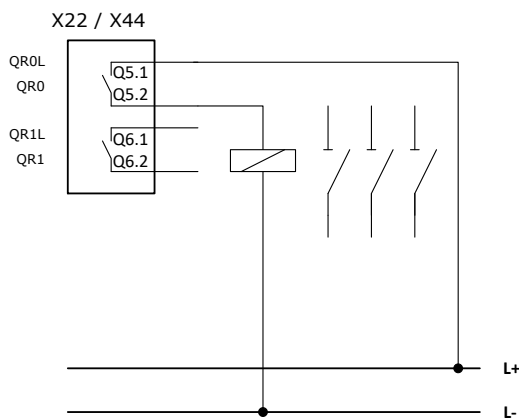

Fig. 25: Single-channel switching relay output.

SAFETY NOTE

- Not recommended for safety applications! In this context see also the notes in EN ISO 13849-1 concerning the application and the required fault exclusions.

10.3.4.2.2. Single-channel switching relay or semi-conductor output with external switching amplifier and testing

When using external switching amplifiers or downstream electro-mechanical, pneumatic or hydraulic components, the setup for testing the complete chain and a message/warning feature for detected faults is required in order to achieve PL c or higher.

Positively guided auxiliary contacts are especially needed for electro-mechanical devices and message contacts for the valve position are required for hydraulic or pneumatic components.

The message/warning device must ensure that the operator recognizes the dangerous situation immediately.

The achievable PL is mainly depending on the test rate, PL d acc. to nach EN ISO 13849-1 can maximally be achieved!

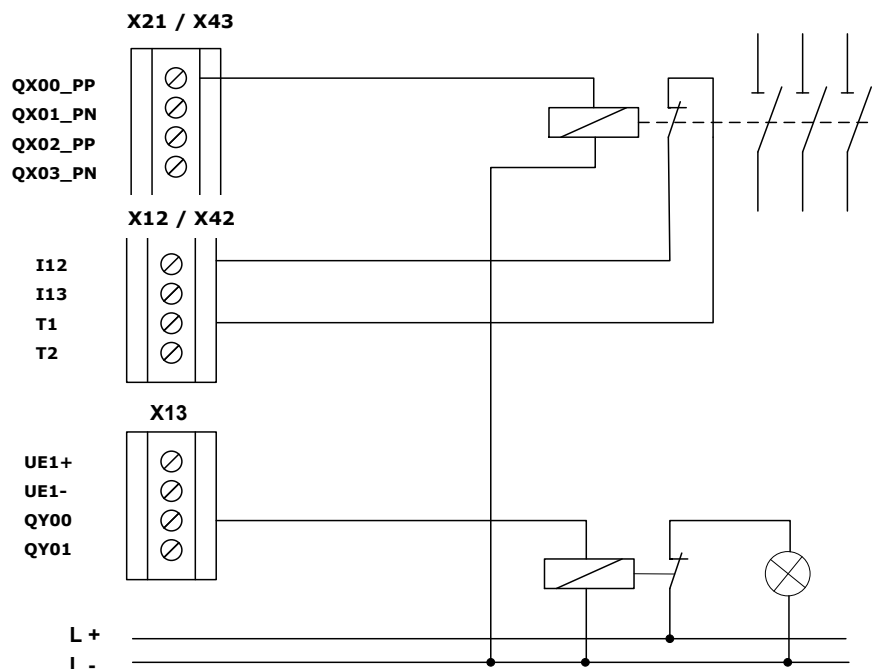

Fig. 26: Single-channel relay output with testing

SAFETY NOTE



- Only conditionally recommended for safety applications! In this context see also the notes in EN ISO 13849-1 concerning the application and the required fault exclusions.
- For category 2 a test rate $\geq 100 \cdot$ request rate is required.
- If a hazardous situation is detected during a test of the safety function, suitable control measures must be initiated. For PL d, a safe state must be initiated which may not be lifted until the fault has been eliminated. For PL up to and including PL c, it is also possible to indicate a fault by means of a warning or signalling device if a safe state cannot be initiated.

10.3.4.2.3. Single-channel switching relay or semi-conductor output with dual-channel external circuit with testing

For safety applications from PL c after EN ISO 13849-1 it is recommended, or demanded to access two external switching off elements. For reaching error of PL c or higher, a device for testing the complete chain and a notification/warning device is further required when an error is recognized – see notes under 10.3.4.2.2.

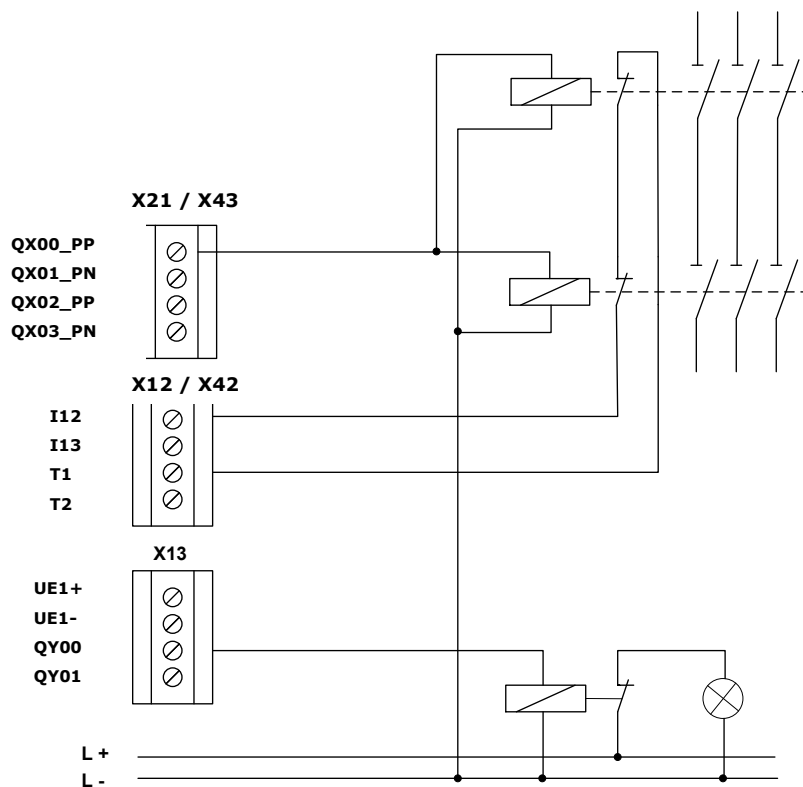

Fig 27: Single-channel switching output *QX00_PP* with dual-channel external circuit and monitoring at output 13 as group feedback

The two external monitoring contacts are switched in series, supplied by the clock signal T1 and read via input 13. Input 13 was chosen as readback input, but any other input can be assigned for this purpose.

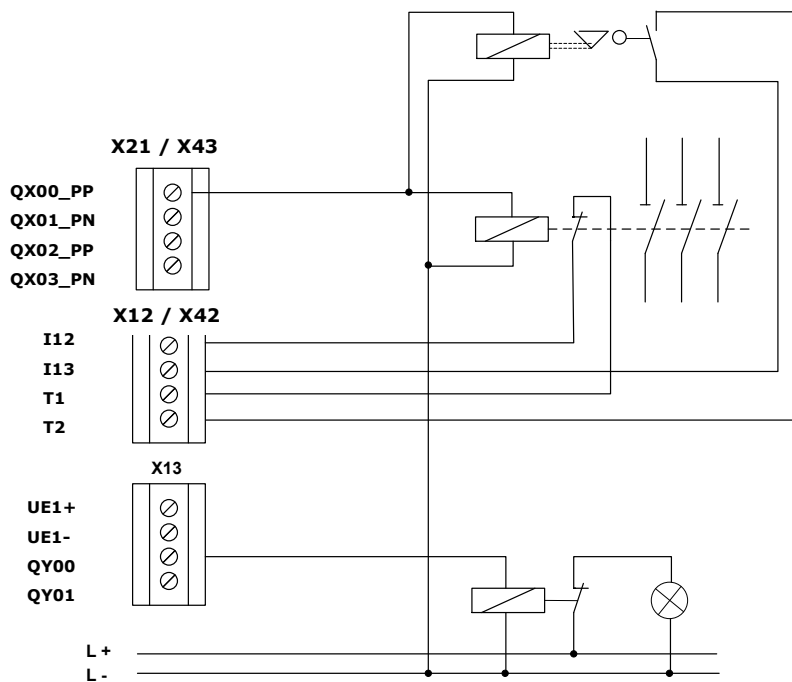

Fig. 28: Single-channel switching output *QX00_PP* with dual-channel external circuit as combination of electro-mechanical element and hydraulic/pneumatic valve and monitoring at two inputs

SAFETY NOTE



- Only conditionally recommended for safety applications! In this context see also the notes in EN ISO 13849-1 concerning the application and the required fault exclusions.
- For PL c and higher a message/warning feature is required, which informs the operator immediately about a dangerous situation
- For higher requirements you must make sure that at least 1 switching operation must take place every 24 hours, in order to test the switching ability of the external power contactor.

10.3.4.2.4. Dual-channel switching relay output with external monitoring-group feedback

For safety related applications from PL d acc. to EN ISO 13849-1 two relays on the SCU/SDU module and two external power contactors are used.

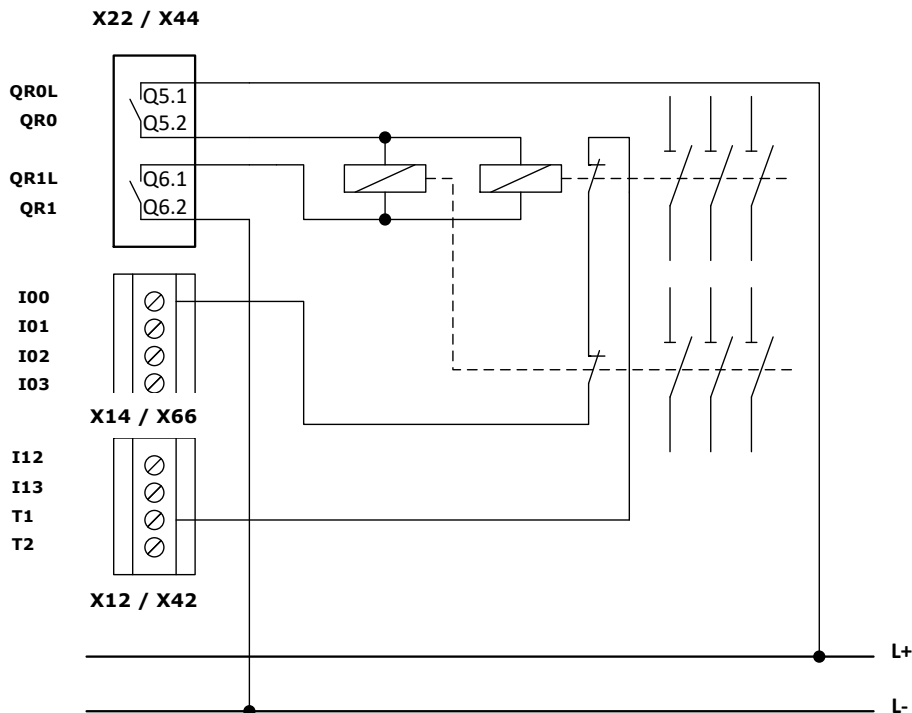

Fig. 29: Two-channel switching relay output with external monitoring – group feedback

The two external monitoring contacts are switched in series, supplied by the clock signal T1 and read in from I00 (configured as EMU-input). In case of higher demands, one must consider that at least 1 switching process must take place every 24 hours.

SAFETY NOTE



- For achieving PL e acc. to EN ISO 13849-1 a sufficiently high testing rate is required.
- For applications with frequent safety shut-down requests these tests should be performed more frequently, e.g. at the beginning of the shift, 1 x per week. However, a test should at least be carried out cyclically 1 x year.

10.3.4.2.5. Dual-channel output with relay output and semi-conductor output – external control circuit with monitoring

For safety applications from PL d and higher acc. to EN ISO 13849-1. The external circuit is controlled in dual-channel mode via a relay and a semi-conductor output. Each of the two external cutout paths is monitored. For PL e acc. to EN ISO 13849-1 a sufficiently high testing rate and $MTTF_D = \text{high}$ is demanded for the external circuit.

Fig. 30: Dual-channel output with relay output and semi-conductor output – external control circuit with monitoring

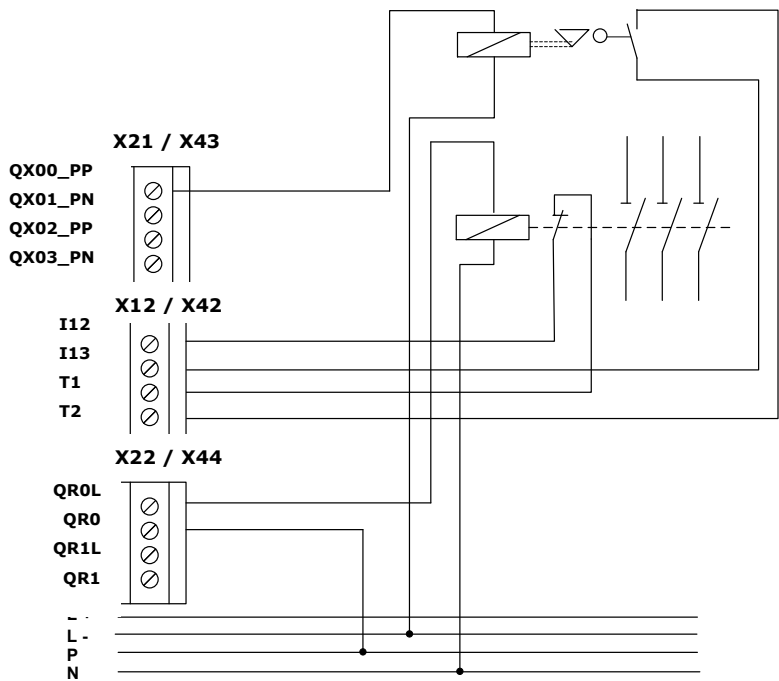

10.3.4.2.6. Dual-channel output with relay output and external control circuit in PL e

For safety applications from PL d and higher acc. to EN ISO 13849-1. The external circuit is controlled in dual-channel mode via the relay outputs. For PL e acc. to EN ISO 13849-1 a sufficiently high testing rate and PL e is demanded for the external circuit.

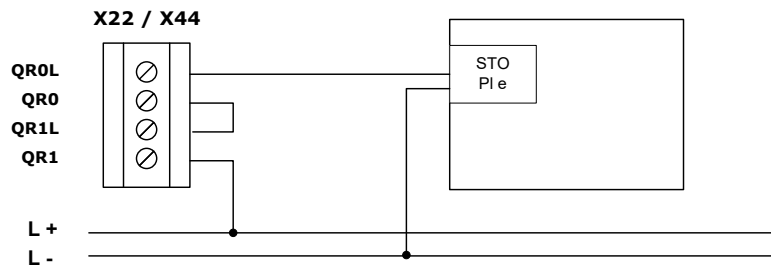

Fig. 31: Dual-channel output with relay output – external control circuit in PL e

10.3.4.2.7. Dual-channel output with semi-conductor output and external control circuit in PL e

For safety applications from PL d and higher acc. to EN ISO 13849-1. The external circuit is controlled in dual-channel mode via the semi-conductor outputs. For PL e acc. to EN ISO 13849-1 PL e is demanded for the external circuit

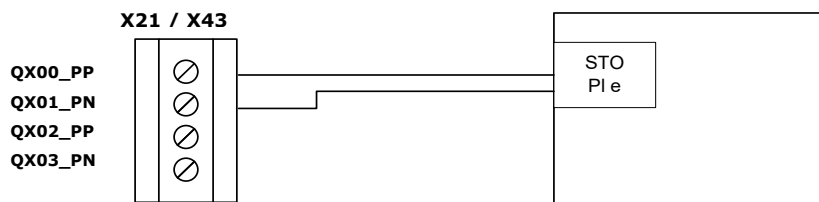

Fig. 32: Dual-channel output with semi-conductor output and external control circuit in PL e

10.3.4.3. Wiring of a auxiliary output

Both semi-conductor outputs implemented on the SDU module can be wired for functional applications. These outputs are not pulse-commutated.

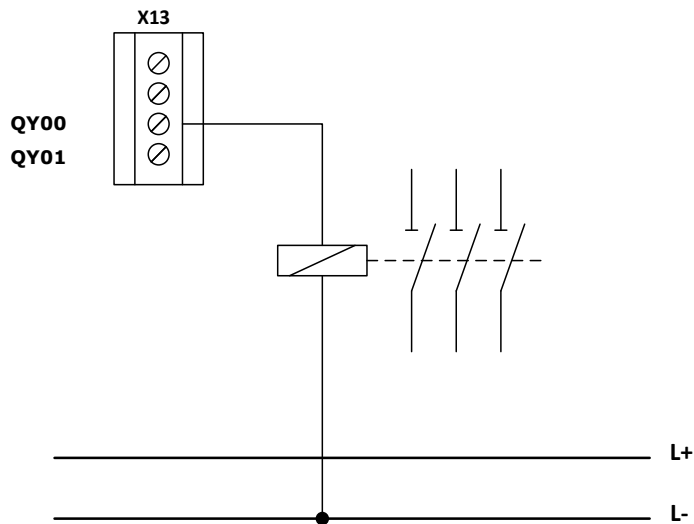

Fig. 33 wiring of a notification output

Applications with notification outputs are not accepted!

10.3.5. Digital outputs I/Os (IQx)

The SCU-2-EC/x and SIO-2 modules have configurable safe digital I/Os (see chapter 6 technical specifications of the SCU series). This connection acts as safe digital pp-switching output parameterized as output (IQx).

10.3.5.1. Classification of the I/Os (IQx) when used as output

Classification	Achievable PI acc. to EN ISO 13849-1	Comment
Static single-channel ⁽²⁾	PL c	Fault detection or fault reaction acc. to cat. 2
Static two-channel ⁽²⁾	PL d	Same group (1): - Time-shifted triggering on PLC level - Fault approach short-circuit on both outputs Different group (1): Nom further requirements necessary
	PL e	Different group ¹⁾ required
Dynamically single-channel ⁽²⁾	PL e	No further requirements necessary
Dynamically dual-channel ⁽²⁾		

Note:

- 1) Group 1: IQ00 ... IQ05
 Group 2: IQ06 ... IQ09
 Group 3: IQ10 ... IQ15
 Group 4: IQ16 ... IQ19
- 2) Static: no pulse test on output
 Dynamic: Pulse test on output $t_{\text{test}} \leq 500 \mu\text{s}$

10.3.5.2. Wiring examples for safe digital outputs I/O 's (IQx)

10.3.5.2.1. Wiring single-channel without testing

When using a two-channel output (IQx) in connection with a single-channel external wiring without external examination it must be taken into account that and adherence of one or several external contacts of the SCU-2-EC/x or SIO-2 module ist not recognized. The following circuitry example is only suitable in a restrictive manner, maximally PL b according to EN ISO 13849-1 can be reached!

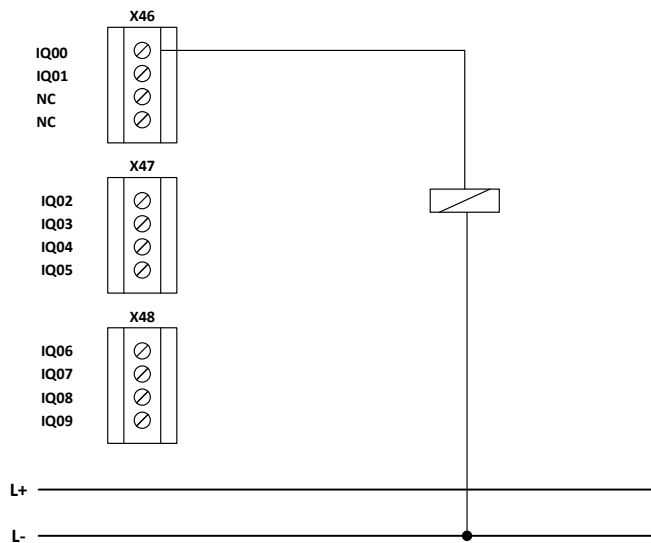

Fig. 34: Two-channel output with single-channel wiring without testing

**SAFETY
NOTE**

- Not recommended for safety applications! In this context see also the notes in EN ISO 13849-1 concerning the application and the required fault exclusions.

10.3.5.2.2. Wiring single-channel with testing

When using a two-channel output Ausgang (IQx) in connection with a single-channel external wiring with testing. Positively guided auxiliary contacts are especially needed for electro-mechanical devices and message contacts for the valve position are required for hydraulic or pneumatic components. Furthermore, a message/warning device for indicating a failure is required. The message/warning device must ensure that the operator recognizes the dangerous situation immediately. The achievable PI is mainly depending on the test rate, PI d acc. to EN ISO 13849-1 can maximally be achieved!

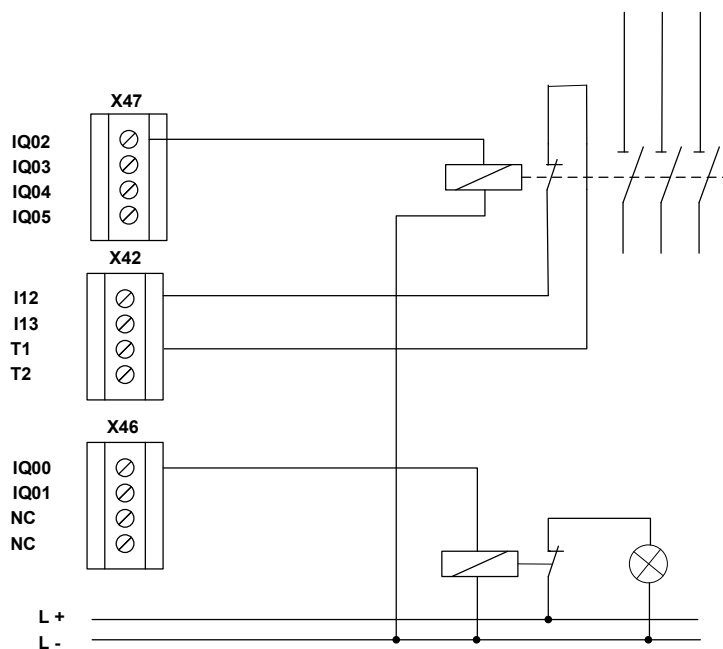

Fig. 35: Two-channel output with single-channel wiring with testing

**SAFETY
NOTE**

- Only conditionally recommended for safety applications! In this context see also the notes in EN ISO 13849-1 concerning the application and the required fault exclusions.
- For category 2 a test rate of $\geq 100 \cdot$ the request rate is required.
- If a hazardous situation is detected during a test of the safety function, suitable control measures must be initiated. For PL d, a safe state must be initiated which may not be lifted until the fault has been eliminated. For PL up to and including PL c, it is also possible to indicate a fault by means of a warning or signalling device if a safe state cannot be initiated.

10.3.5.2.3. Wiring with safe cut-off circuit

For safety applications from PL c and higher acc. to EN ISO 13849-1. The external circuit is controlled directly via a two-channel output. The achievable PL acc. to EN ISO 13849-1 depends on the use of dynamic testing (see 10.2.1.3.2 DC) and the PL of the downstream device.

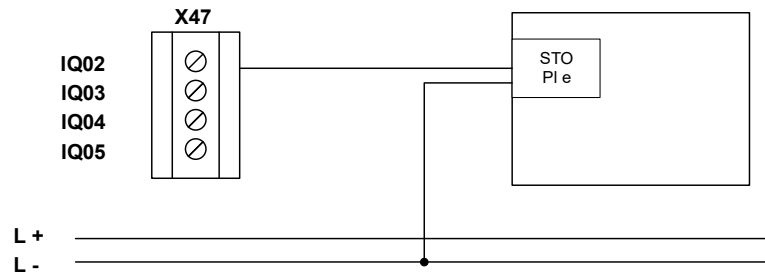

Fig. 36: two-channel output in connection with a device with examined disconnection

10.3.5.2.4. Wiring in connection with two-channel switching cut-off

Suitable for PL d and higher acc. to EN ISO 13849-1. Use of one output IQx in conjunction with two-channel external wiring with test. Positively guided auxiliary contacts are especially needed for electro-mechanical devices and message contacts for the valve position are required for hydraulic or pneumatic components.

The achievable PL depends on the use of dynamic testing as well as MTTFD-value of the external channel. PL e acc. to EN ISO 13849-1 can maximally be reached!

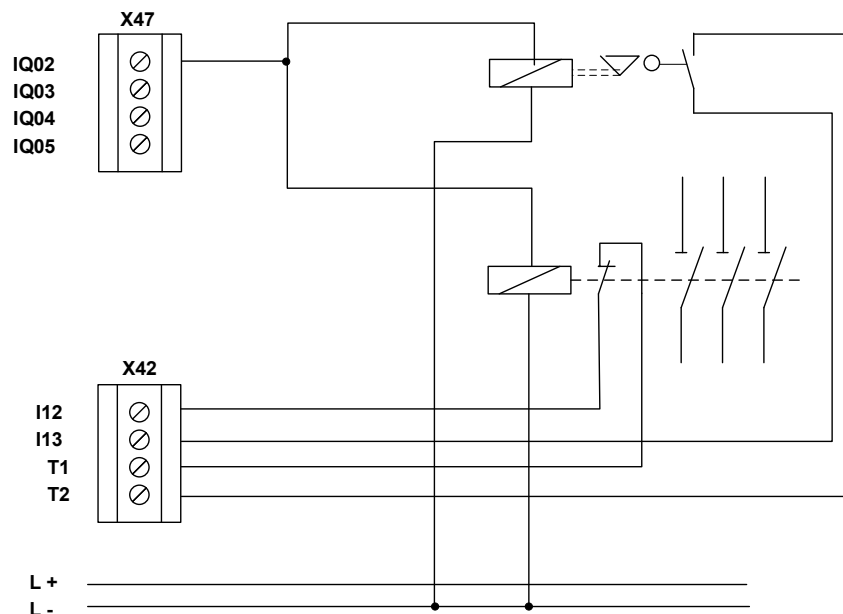

Fig. 37: two-channel output in connection with two-channel cut-off circuit with testing

10.3.5.2.5. Redundant two-channel output

Suitable for PL d and higher acc. to EN ISO 13849-1. Use of two outputs IQx in connection with a dual-channel external wiring.

10.3.5.2.5.1. Wiring dual-channel in the same group

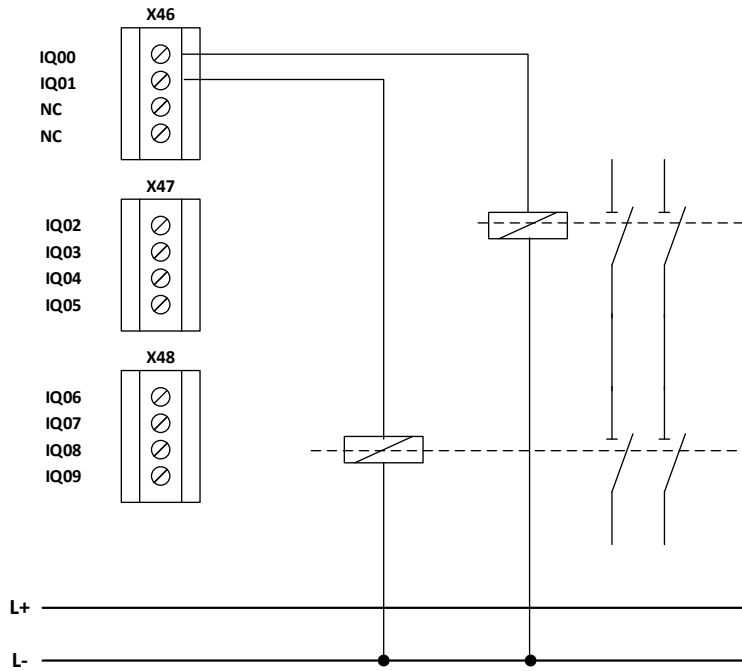

Fig. 38: Redundant two-channel outputs in the same group in connection with two-channel cut-off circuit

10.3.5.2.5.2. Wiring dual-channel in different groups

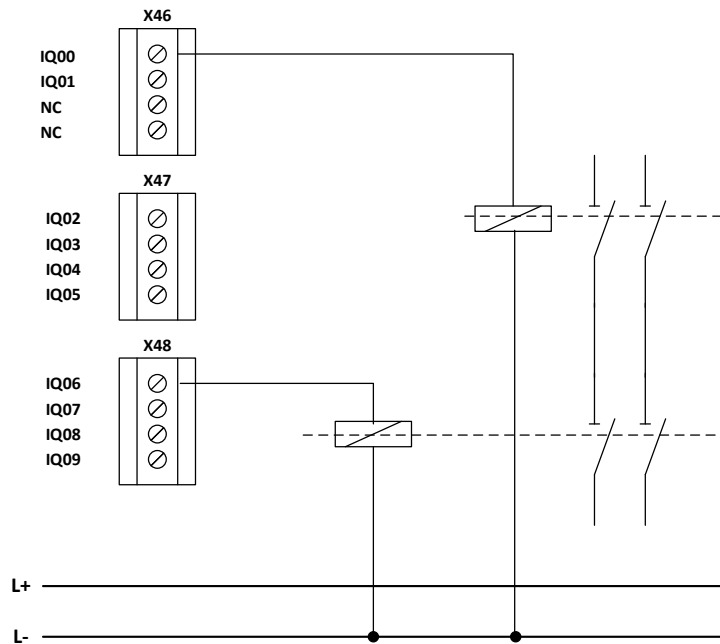

Fig. 39: Redundant two-channel outputs in different groups in connection with two-channel switching-off circuit

**SAFETY
NOTE**



- For a safety related assessment of the partial system output the data issued by the respective manufacturer (MTTF_D, FIT-numbers, B10d-value, etc.) must be used when using external elements, e.g. for switching amplification, in the shut-down circuit.
- The DC-values listed in the table must be used conservatively and compliance with the boundary conditions (see table under „Remarks“) must be ensured.
- According to the applicable standards, fault exclusions are permitted. The boundary conditions mentioned in this context must permanently be met.
- When using elements for switching amplification in safety circuits, their function must be monitored by means of suitable readback contacts, etc. (see circuitry examples). Suitable readback contacts are contacts which are linked with the contacts in the shut-down circuit in a positively switching way.
- The switching ability of the external switching amplifier must be cyclically tested. The time between 2 tests must be determined in accordance with the requirements of the application and ensured by suitable measures. Suitable measures may be of organizational (On and Off switching at the beginning of a shift, etc.) or technical (automatic, cyclic switching) nature.

10.3.5.3. Overview of achievable PL for digital safety outputs

Output SCU, SIO	Actuator / external cut-off circuit	Cat. Acc. to EN ISO 1384 9-1	DC		MTTF _D Actuator	Achievable PL acc. to EN ISO 1384 9-1	Boundary conditions	Fault exclusion
Single-channel without dynamic output test QR0 or QR1	Single-channel Contactor, valve, brake, etc. without direct feedback for diagnostics.	Cat. B	0%		Medium	B	Contactors and downstream actuators appropriately designed for safety application	
QX00..QX04 IQx	Single-channel Contactor, valve, brake, etc. with monitored and positively guided auxiliary contact	Cat. 2	60-90 %	Depending on switching frequency	Medium	B	Auxiliary output required for warning in case of detected malfunction Contactors and downstream actuators appropriately designed for safety application	
					Hoch	C	As before	
						D	As before DC = 90 % due to a sufficiently high test rate with reference to the application	
Single-channel without dynamic output test QR0 or QR1 or single-channel QX00..QX04	Dual channel Contactor, valve, brake, etc. with direct feedback for diagnostics at least in one channel or actuator single-channel controlled with safety function cat. 3 (e.g. STO)	Cat. 2	90 %	Monitoring only in an external shut-down circuit	Medium High	c d	Auxiliary output required for warning in case of detected malfunction Contactors and downstream actuators appropriately designed for safety application	Short circuit on external control

Single-channel without dynamic output test IQx	Dual channel Contactor, valve, brake, etc. with direct feedback for diagnostics at least in one channel or actuator single-channel controlled with safety function cat. 3 (e.g. STO)	Cat. 3	90 %	Monitoring only in an external shut-down circuit	Medium or High	d	Contactor and downstream actuators appropriately designed for safety application	Short circuit on external control
Single-channel with dynamic output test IQx	Dual channel Contactor, valve, brake, etc. with direct feedback for diagnostics at least in one channel or actuator with safety function cat. 4 (e.g. STO)	Cat. 4	99 %	Monitoring in both external shut-down circuits	High	e	Contactor and downstream actuators appropriately designed for safety application Monitoring of electro-mechanical components by means of positively guided switches, position monitoring of control valves, etc.	
Dual-channel without dynamic output test QR0 and QR1 2 x IQx	Zweikanalig Schütz, Ventil, Bremse etc. mit direkter Rückführung zur Diagnose mind. in einem Kanal oder Aktuator mit Sicherheitsfunktion Kat. 4 (z.B. STO)	Cat. 3	90 %	Monitoring in both external shut-down circuits	Medium or High	d	Contactor and downstream actuators appropriately designed for safety application Monitoring of electro-mechanical components by means of positively guided switches, position monitoring of control valves, etc. Outputs IQ00..39 x each from different groups (groups of 6/4	Short circuit on external control

							<p>IQ-Ports each, e.g. IQ05, IQ06..09</p> <p>or</p> <p>Time-shifted triggering on PLC level</p>	
<p>Dual-channel QR0 and QR1 or Dual-channel with dynamic output test</p> <p>QX00..QX04 IQx</p>	<p>Dual-channel Contactor, valve, brake, etc. with direct feedback for diagnostics at least in one channel or actuator with safety function cat. 4 (e.g. STO)</p>	Cat. 4	99 %	Monitoring in both external shut-down circuits	High	e	<p>Contactor and downstream actuators appropriately designed for safety application</p> <p>Monitoring of electro-mechanical components by means of positively guided switches, position monitoring of control valves, etc.</p> <p>For applications with frequent safety shut-down requests these tests should be performed more frequently, e.g. at the beginning of the shift, 1 x per week. However, a test should at least be carried out cyclically 1 x year.</p>	Short-circuit in external control in both channels



11. Switch types

Table 4: switch types

N.C. = Normally closed

N.O. = normally open

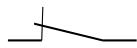
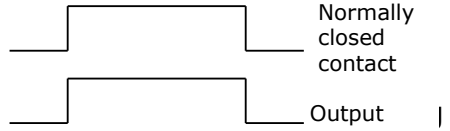
O = output

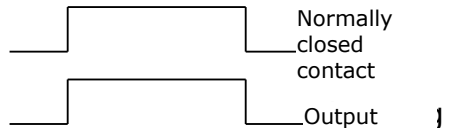
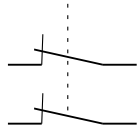
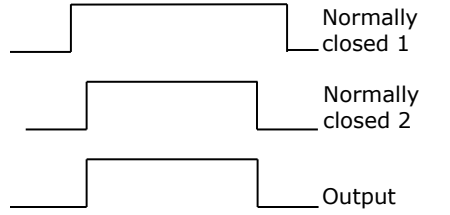
Type	Graphic symbols	Truth table	Logic function	Function block	Function																
1	 eSwitch_1o	<table border="1"> <tr> <td>N.C.</td> <td>O</td> </tr> <tr> <td>0</td> <td>0</td> </tr> <tr> <td>1</td> <td>1</td> </tr> </table>	N.C.	O	0	0	1	1	LD E.1 ST IE.X		Closing contact (N.O.), only in display opening contact (O)										
N.C.	O																				
0	0																				
1	1																				
2	 sSwitch_1s	<table border="1"> <tr> <td>N.O.</td> <td>O</td> </tr> <tr> <td>0</td> <td>0</td> </tr> <tr> <td>1</td> <td>1</td> </tr> </table>	N.O.	O	0	0	1	1	LD E.1 ST IE.X		Normally open, as type 1										
N.O.	O																				
0	0																				
1	1																				
3	 eSwitch_2o	<table border="1"> <tr> <td>N.C.1</td> <td>N.C. 2</td> <td>O</td> </tr> <tr> <td>0</td> <td>0</td> <td>0</td> </tr> <tr> <td>1</td> <td>0</td> <td>0</td> </tr> <tr> <td>0</td> <td>1</td> <td>0</td> </tr> <tr> <td>1</td> <td>1</td> <td>1</td> </tr> </table> <p>N.C. = Normally closed N.O. = normally open O = output</p>	N.C.1	N.C. 2	O	0	0	0	1	0	0	0	1	0	1	1	1	LD E.1 AND E.2 ST IE.X		AND operation of both inputs	
N.C.1	N.C. 2	O																			
0	0	0																			
1	0	0																			
0	1	0																			
1	1	1																			

11

Switch types

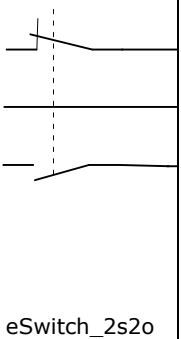
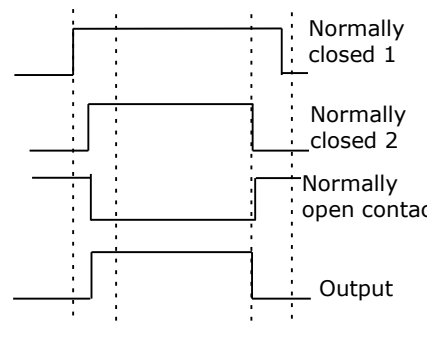
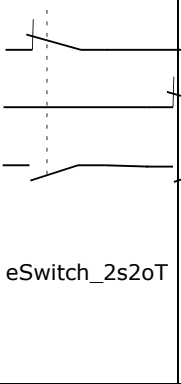
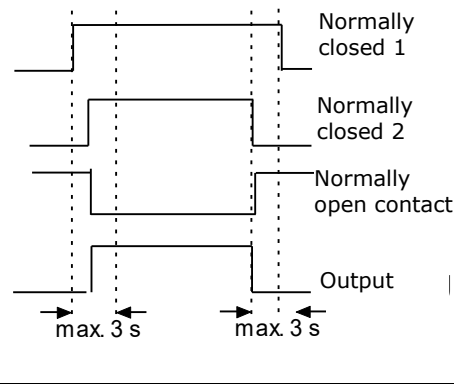
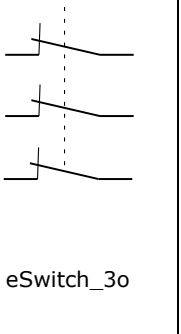
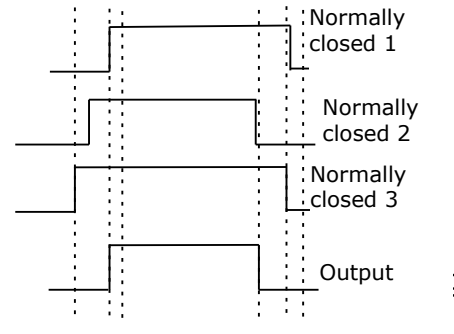

<p>4</p> <p>eSwitch_2oT</p>	<table border="1"> <thead> <tr> <th>N.C.1</th> <th>N.C.2</th> <th>O</th> </tr> </thead> <tbody> <tr> <td>0</td> <td>0</td> <td>0</td> </tr> <tr> <td>1</td> <td>0</td> <td>0</td> </tr> <tr> <td>0</td> <td>1</td> <td>0</td> </tr> <tr> <td>1</td> <td>1</td> <td>1</td> </tr> </tbody> </table>	N.C.1	N.C.2	O	0	0	0	1	0	0	0	1	0	1	1	1	<p>N.C. = Normally closed N.O. = normally open O = output</p>	<p>LD E.1 OR E.2 ST META_EN.1</p> <p>LD E.1 AND E.2 ST METB_EN.1</p> <p>LD MET.1 ST IE.X</p>	<p>Time monitoring MET1..MET4</p>	<p>Like 3, but with time monitoring of state changes. In case of signal changes at N.O. or N.C. a complementary signal must follow within a period of $t=3$ s. If not, detect fault and $O=0$</p>	<p>Normally closed 1</p> <p>Normally closed 2</p> <p>Output</p> <p>max. 3 s</p>
N.C.1	N.C.2	O																			
0	0	0																			
1	0	0																			
0	1	0																			
1	1	1																			
<p>5</p> <p>eSwitch_1s1o</p>	<table border="1"> <thead> <tr> <th>N.O.</th> <th>N.C.</th> <th>O</th> </tr> </thead> <tbody> <tr> <td>0</td> <td>0</td> <td>0</td> </tr> <tr> <td>1</td> <td>0</td> <td>0</td> </tr> <tr> <td>0</td> <td>1</td> <td>1</td> </tr> <tr> <td>1</td> <td>1</td> <td>0</td> </tr> </tbody> </table>	N.O.	N.C.	O	0	0	0	1	0	0	0	1	1	1	1	0	<p>N.C. = Normally closed N.O. = normally open O = output</p>	<p>LD E.1 AND NOT E.2 ST IE.X</p>		<p>Monitoring for $S=$inactive and N.C.=active</p>	<p>Normally closed contact</p> <p>Normally open contact</p> <p>Output</p> <p>max. 3 s</p>
N.O.	N.C.	O																			
0	0	0																			
1	0	0																			
0	1	1																			
1	1	0																			
<p>6</p> <p>eSwitch_1s1oT</p>	<table border="1"> <thead> <tr> <th>N.O.</th> <th>N.C.</th> <th>O</th> </tr> </thead> <tbody> <tr> <td>0</td> <td>0</td> <td>0</td> </tr> <tr> <td>1</td> <td>0</td> <td>0</td> </tr> <tr> <td>0</td> <td>1</td> <td>1</td> </tr> <tr> <td>1</td> <td>1</td> <td>0</td> </tr> </tbody> </table>	N.O.	N.C.	O	0	0	0	1	0	0	0	1	1	1	1	0	<p>N.C. = Normally closed N.O. = normally open O = output</p>	<p>LD E.1 OR NOT E.2 ST META_EN.1</p> <p>LD E1 AND NOT E2 ST METB_EN.1</p> <p>LD MET.1 ST IE.X</p>	<p>Time Monitoring MET1..MET4</p>	<p>Like 5, but with time monitoring of state changes. In case of signal changes at N.O. or N.C. a complementary signal must follow within a period of $t=3$ s. If not, detect fault and $O=0$</p>	<p>Normally closed contact</p> <p>Normally open contact</p> <p>Output</p> <p>max. 3 s</p>
N.O.	N.C.	O																			
0	0	0																			
1	0	0																			
0	1	1																			
1	1	0																			

<p>7</p>  <p>eSwitch_2s2o</p>	<table border="1"> <thead> <tr> <th>N.O.</th> <th>N.C.</th> <th>N.O.</th> <th>N.C.</th> <th>O</th> </tr> </thead> <tbody> <tr> <td>1</td> <td>1</td> <td>2</td> <td>2</td> <td>0</td> </tr> <tr> <td>1</td> <td>0</td> <td>1</td> <td>0</td> <td>0</td> </tr> <tr> <td>0</td> <td>1</td> <td>1</td> <td>0</td> <td>0</td> </tr> <tr> <td>0</td> <td>1</td> <td>0</td> <td>1</td> <td>1</td> </tr> <tr> <td>1</td> <td>0</td> <td>0</td> <td>1</td> <td>0</td> </tr> </tbody> </table>	N.O.	N.C.	N.O.	N.C.	O	1	1	2	2	0	1	0	1	0	0	0	1	1	0	0	0	1	0	1	1	1	0	0	1	0	<p>LD E.1 AND E.2 AND NOT E.3 ST IE.X</p>	<p>Monitoring for N.O.1*N.O.2=inactive and N.C.1*N.C.2=active</p>	
N.O.	N.C.	N.O.	N.C.	O																														
1	1	2	2	0																														
1	0	1	0	0																														
0	1	1	0	0																														
0	1	0	1	1																														
1	0	0	1	0																														
<p>8</p>  <p>eSwitch_2s2oT</p>	<table border="1"> <thead> <tr> <th>N.O.</th> <th>N.C.</th> <th>N.O.</th> <th>N.C.</th> <th>O</th> </tr> </thead> <tbody> <tr> <td>1</td> <td>1</td> <td>2</td> <td>2</td> <td>0</td> </tr> <tr> <td>1</td> <td>0</td> <td>1</td> <td>0</td> <td>0</td> </tr> <tr> <td>0</td> <td>1</td> <td>1</td> <td>0</td> <td>0</td> </tr> <tr> <td>0</td> <td>1</td> <td>0</td> <td>1</td> <td>1</td> </tr> <tr> <td>1</td> <td>0</td> <td>0</td> <td>1</td> <td>0</td> </tr> </tbody> </table>	N.O.	N.C.	N.O.	N.C.	O	1	1	2	2	0	1	0	1	0	0	0	1	1	0	0	0	1	0	1	1	1	0	0	1	0	<p>LD E.1 OR E.2 OR NOT E.3 ST META_EN.1</p> <p>LD E.1 AND E.2 AND NOT E.3 ST METB_EN.1</p> <p>LD MET.1 ST IE.X</p>	<p>Time Monitoring MET1..MET4</p> <p>Like 6, but with time monitoring of state changes. In case of signal changes at N.O. (Attention: Bus line) or N.C. a complementary signal must follow within a period of t=3 s. If not, detect fault and O=0</p>	
N.O.	N.C.	N.O.	N.C.	O																														
1	1	2	2	0																														
1	0	1	0	0																														
0	1	1	0	0																														
0	1	0	1	1																														
1	0	0	1	0																														
<p>9</p>  <p>eSwitch_3o</p> <p>N.C. = Normally closed N.O. = normally open O = output</p>	<table border="1"> <thead> <tr> <th>N.C.</th> <th>N.C.</th> <th>N.C.</th> <th>O</th> </tr> </thead> <tbody> <tr> <td>1</td> <td>2</td> <td>3</td> <td></td> </tr> <tr> <td>0</td> <td>0</td> <td>0</td> <td>0</td> </tr> <tr> <td>1</td> <td>0</td> <td>0</td> <td>0</td> </tr> <tr> <td>0</td> <td>1</td> <td>0</td> <td>0</td> </tr> <tr> <td>1</td> <td>1</td> <td>0</td> <td>0</td> </tr> <tr> <td>1</td> <td>1</td> <td>1</td> <td>1</td> </tr> </tbody> </table>	N.C.	N.C.	N.C.	O	1	2	3		0	0	0	0	1	0	0	0	0	1	0	0	1	1	0	0	1	1	1	1	<p>LD E.1 AND E.2 AND E.3 ST IE.X</p>	<p>AND operation of both inputs</p>			
N.C.	N.C.	N.C.	O																															
1	2	3																																
0	0	0	0																															
1	0	0	0																															
0	1	0	0																															
1	1	0	0																															
1	1	1	1																															

11

Switch types





<p>10</p>	<p>eSwitch_3oT</p>	<table border="1"> <thead> <tr> <th>N.C. 1</th> <th>N.C. 2</th> <th>N.C. 3</th> <th>O</th> </tr> </thead> <tbody> <tr> <td>1</td> <td>2</td> <td>3</td> <td>0</td> </tr> <tr> <td>0</td> <td>0</td> <td>0</td> <td>0</td> </tr> <tr> <td>1</td> <td>0</td> <td>0</td> <td>0</td> </tr> <tr> <td>0</td> <td>1</td> <td>0</td> <td>0</td> </tr> <tr> <td>1</td> <td>1</td> <td>0</td> <td>0</td> </tr> <tr> <td>1</td> <td>1</td> <td>1</td> <td>1</td> </tr> </tbody> </table>	N.C. 1	N.C. 2	N.C. 3	O	1	2	3	0	0	0	0	0	1	0	0	0	0	1	0	0	1	1	0	0	1	1	1	1	<p>LD E.1 OR E.2 OR E.3 ST META_EN.1</p> <p>LD E.1 AND E.2 AND E.3 ST METB_EN.1 LD MET.1</p> <p>ST IE.X</p>	<p>Time Monitoring MET1..MET4</p>	<p>Like 8, but with time monitoring of state changes.</p> <p>In case of signal change on one of the N.C.-inputs the other inputs must follow within a period of $t=3$ s. If not, detect fault and $O=0$</p>	<p>Normally closed 1 Normally closed 2 Normally closed 3 Output</p> <p>max. 3 s max. 3 s</p>		
N.C. 1	N.C. 2	N.C. 3	O																																	
1	2	3	0																																	
0	0	0	0																																	
1	0	0	0																																	
0	1	0	0																																	
1	1	0	0																																	
1	1	1	1																																	
<p>11</p>	<p>eTwoHand_2o</p> <p>N.C. = Normally closed N.O. = normally open O = output</p>	<table border="1"> <thead> <tr> <th>N.C. 1</th> <th>N.O. 1</th> <th>N.C. 2</th> <th>N.O. 2</th> <th>O</th> </tr> </thead> <tbody> <tr> <td>1</td> <td>1</td> <td>2</td> <td>2</td> <td>0</td> </tr> <tr> <td>0</td> <td>1</td> <td>0</td> <td>1</td> <td>0</td> </tr> <tr> <td>1</td> <td>0</td> <td>0</td> <td>1</td> <td>0</td> </tr> <tr> <td>1</td> <td>0</td> <td>1</td> <td>0</td> <td>0</td> </tr> <tr> <td>0</td> <td>1</td> <td>0</td> <td>1</td> <td>1</td> </tr> </tbody> </table>	N.C. 1	N.O. 1	N.C. 2	N.O. 2	O	1	1	2	2	0	0	1	0	1	0	1	0	0	1	0	1	0	1	0	0	0	1	0	1	1	<p>LD NOT E.1 OR E.2 OR NOT E.3 OR E.4 ST MEZ_EN.1</p> <p>LD E.1 AND NOT E2 AND E3 AND NOT E4 ST MEZ_EN.2</p> <p>LD NOT E1 AND E.2 AND NOT E3 AND E.4 ST MEZ_EN.3</p> <p>LD MEZ.1 ST IE.X</p>	<p>Two-hand operation MEZ</p>	<p>Monitoring for N.O.1* N.O.2=inactive and N.C.1*N.C.2=active + temporal monitoring of this status. This means that in case of a signal change of an N.O. from 1->0 or N.C. from 0->1, the other signals (i.e. further N.O.=0 or N.C.=1) must follow within a period of 0.5 s. If not, the output = 0.</p> <p>No interference evaluation! No temporal monitoring when changing to inactive state.</p>	<p>Normally closed 1 / open 1 Normally closed 1 / open 2 Output</p> <p>max. 0,5 s</p>
N.C. 1	N.O. 1	N.C. 2	N.O. 2	O																																
1	1	2	2	0																																
0	1	0	1	0																																
1	0	0	1	0																																
1	0	1	0	0																																
0	1	0	1	1																																

11

Switch types

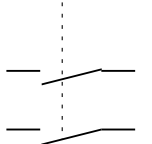
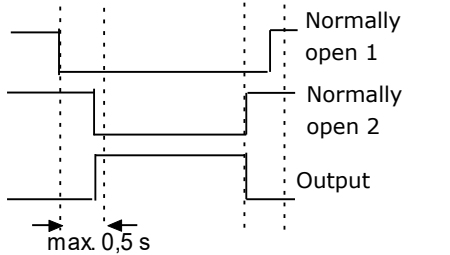

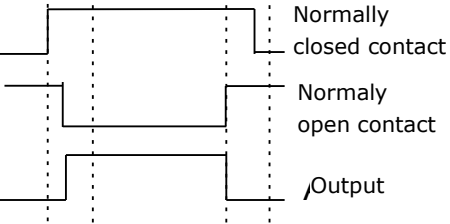
<p>12</p>	 <p>eTwoHand_2s</p>	<table border="1" data-bbox="443 225 645 419"> <thead> <tr> <th>N.O.</th> <th>N.O.</th> <th>O</th> </tr> <tr> <th>1</th> <th>2</th> <th></th> </tr> </thead> <tbody> <tr> <td>1</td> <td>0</td> <td>0</td> </tr> <tr> <td>0</td> <td>1</td> <td>0</td> </tr> <tr> <td>0</td> <td>0</td> <td>0</td> </tr> <tr> <td>1</td> <td>1</td> <td>1</td> </tr> </tbody> </table> <p>N.C. = Normally closed N.O. = normally open O = output</p>	N.O.	N.O.	O	1	2		1	0	0	0	1	0	0	0	0	1	1	1	<p>LD E.1 OR E.2 ST MEZ_EN.1</p> <p>LD NOT E.1 AND NOT E.2 ST MEZ_EN.2</p> <p>LD E.1 AND E.2 ST MEZ_EN.3</p> <p>LD MEZ.1 ST IE.X</p>	<p>Two-hand operation MEZ</p>	<p>Monitoring for N.O.1*N.O.2=inactive + temporal monitoring of this status. This means that in case of a signal change of one N.O. from 1->0 the other signal (i.e. another N.O.=0) must follow within a period of 0.5 s. If not, the output = 0. No interference evaluation! No temporal monitoring when changing to inactive state.</p>	 <p>Normally open 1</p> <p>Normally open 2</p> <p>Output</p> <p>max. 0,5 s</p>		
N.O.	N.O.	O																								
1	2																									
1	0	0																								
0	1	0																								
0	0	0																								
1	1	1																								
<p>13</p>	 <p>eMode_1s1o</p>	<table border="1" data-bbox="443 724 660 895"> <thead> <tr> <th>S1</th> <th>S2</th> <th>O1</th> <th>O2</th> </tr> </thead> <tbody> <tr> <td>1</td> <td>0</td> <td>1</td> <td>0</td> </tr> <tr> <td>0</td> <td>1</td> <td>0</td> <td>1</td> </tr> <tr> <td>0</td> <td>0</td> <td>0</td> <td>0</td> </tr> <tr> <td>1</td> <td>1</td> <td>0</td> <td>0</td> </tr> </tbody> </table> <p>S= Switch</p>	S1	S2	O1	O2	1	0	1	0	0	1	0	1	0	0	0	0	1	1	0	0	<p>LD E.1 AND NOT E.2 ST IE.X1</p> <p>LD NOT E.1 AND E.2 ST IE.X2</p>	<p>Selector switch</p>	<p>Clear linkage of permissible switch positions</p>	 <p>Normally closed contact</p> <p>Normally open contact</p> <p>Output</p>
S1	S2	O1	O2																							
1	0	1	0																							
0	1	0	1																							
0	0	0	0																							
1	1	0	0																							

11

Switch types

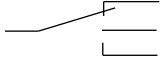
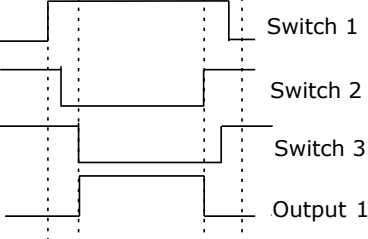
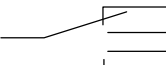
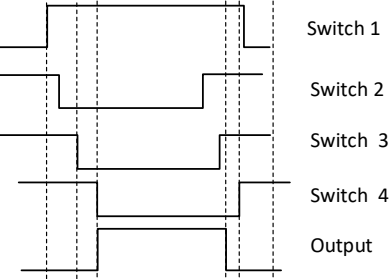

<p>14</p>  <p>eMode_3switch</p>	<table border="1"> <thead> <tr> <th>S1</th> <th>S2</th> <th>S3</th> <th>O1</th> <th>O2</th> <th>O3</th> </tr> </thead> <tbody> <tr><td>1</td><td>0</td><td>0</td><td>1</td><td>0</td><td>0</td></tr> <tr><td>0</td><td>1</td><td>0</td><td>0</td><td>1</td><td>0</td></tr> <tr><td>0</td><td>0</td><td>1</td><td>0</td><td>0</td><td>1</td></tr> <tr><td>1</td><td>1</td><td>0</td><td>0</td><td>0</td><td>0</td></tr> <tr><td>1</td><td>0</td><td>1</td><td>0</td><td>0</td><td>0</td></tr> <tr><td>0</td><td>1</td><td>1</td><td>0</td><td>0</td><td>0</td></tr> <tr><td>1</td><td>1</td><td>1</td><td>0</td><td>0</td><td>0</td></tr> <tr><td>0</td><td>0</td><td>0</td><td>0</td><td>0</td><td>0</td></tr> </tbody> </table>	S1	S2	S3	O1	O2	O3	1	0	0	1	0	0	0	1	0	0	1	0	0	0	1	0	0	1	1	1	0	0	0	0	1	0	1	0	0	0	0	1	1	0	0	0	1	1	1	0	0	0	0	0	0	0	0	0	<p>LD E.1 AND NOT E.2 AND NOT E.3 ST IE.X1</p> <p>LDN E.1 AND E2 AND NOT E.3 ST IE.X2</p> <p>LDN E.1 AND NOT E.2 AND E.3 ST IE.X3</p>	<p>Selector switch</p>	<p>Clear linkage of permissible switch positions</p>																																			
S1	S2	S3	O1	O2	O3																																																																																								
1	0	0	1	0	0																																																																																								
0	1	0	0	1	0																																																																																								
0	0	1	0	0	1																																																																																								
1	1	0	0	0	0																																																																																								
1	0	1	0	0	0																																																																																								
0	1	1	0	0	0																																																																																								
1	1	1	0	0	0																																																																																								
0	0	0	0	0	0																																																																																								
<p>15</p>  <p>eMode_4switch</p>	<table border="1"> <thead> <tr> <th>S1</th> <th>S2</th> <th>S3</th> <th>S4</th> <th>A1</th> <th>A2</th> <th>A3</th> <th>A4</th> </tr> </thead> <tbody> <tr><td>1</td><td>0</td><td>0</td><td>0</td><td>1</td><td>0</td><td>0</td><td>0</td></tr> <tr><td>0</td><td>1</td><td>0</td><td>0</td><td>0</td><td>1</td><td>0</td><td>0</td></tr> <tr><td>0</td><td>0</td><td>1</td><td>0</td><td>0</td><td>0</td><td>1</td><td>0</td></tr> <tr><td>0</td><td>0</td><td>0</td><td>1</td><td>0</td><td>0</td><td>0</td><td>1</td></tr> <tr><td>1</td><td>1</td><td>1</td><td>0</td><td>0</td><td>0</td><td>0</td><td>0</td></tr> <tr><td>1</td><td>1</td><td>0</td><td>1</td><td>0</td><td>0</td><td>0</td><td>0</td></tr> <tr><td>1</td><td>0</td><td>1</td><td>1</td><td>0</td><td>0</td><td>0</td><td>0</td></tr> <tr><td>0</td><td>1</td><td>1</td><td>1</td><td>0</td><td>0</td><td>0</td><td>0</td></tr> <tr><td>1</td><td>1</td><td>1</td><td>1</td><td>0</td><td>0</td><td>0</td><td>0</td></tr> <tr><td>0</td><td>0</td><td>0</td><td>0</td><td>0</td><td>0</td><td>0</td><td>0</td></tr> </tbody> </table>	S1	S2	S3	S4	A1	A2	A3	A4	1	0	0	0	1	0	0	0	0	1	0	0	0	1	0	0	0	0	1	0	0	0	1	0	0	0	0	1	0	0	0	1	1	1	1	0	0	0	0	0	1	1	0	1	0	0	0	0	1	0	1	1	0	0	0	0	0	1	1	1	0	0	0	0	1	1	1	1	0	0	0	0	0	0	0	0	0	0	0	0	<p>LD E.1 AND NOT E.2 AND NOT E.3 ST IE.X1</p> <p>LD NOT E.1 AND E.2 AND NOT E.3 ST IE.X2</p> <p>LD NOT E.1 AND NOT E.2 AND E.3 ST IE.X3</p> <p>LD NOT E.1 AND NOT E.2 AND NOT E.3 AND E.4 ST IE.X4</p>	<p>Selector switch</p>	<p>Clear linkage of permissible switch positions</p>	
S1	S2	S3	S4	A1	A2	A3	A4																																																																																						
1	0	0	0	1	0	0	0																																																																																						
0	1	0	0	0	1	0	0																																																																																						
0	0	1	0	0	0	1	0																																																																																						
0	0	0	1	0	0	0	1																																																																																						
1	1	1	0	0	0	0	0																																																																																						
1	1	0	1	0	0	0	0																																																																																						
1	0	1	1	0	0	0	0																																																																																						
0	1	1	1	0	0	0	0																																																																																						
1	1	1	1	0	0	0	0																																																																																						
0	0	0	0	0	0	0	0																																																																																						

12. Commissioning and start

The assembly can only be used after it has been programmed.
For programming, please observe the Programming Manual SCU.

DANGER



Work on the wiring or work at the electrical system can cause electric shock. Electric shock can cause death. Thus, only persons qualified according to TRBS 1203 may carry out work on the wiring or work on the electrical system.

12.1. Switch-on sequence

If the assembly runs correctly, after every restart of the assembly the following phases are passed through. The respective phases are indicated on the 7-segment display on the front side of the assembly.

7 segment display	Mode	Description
„1“	STARTUP	Synchronization between the two processor systems and check of the configuration data / check of the firmware data
„2“	SENDCONFIG	Distribution of the configuration data / Configuration of the firmware data, and second check of these data. Afterwards range check of the configuration data.
„3“	STARTUP BUS	If available, initializing of a bus system.
„4“	RUN	Standard operation of the system, All outputs are are switched according to the current state of the logic.
„5“	STOP	In the Stop mode, parameter data and program data can be loaded externally.
„6“	Error	Error mode of the assembly. All outputs are switched off. Error can only be reset via ON / OFF of the assembly.
„7“	Alarm	Alarm mode of the assembly. All outputs are switched off. Alarm can be reset either via digital input or via the acknowledge button that is situated on the front side.
„8“	Local mode	Local mode of the assembly. Normal mode without network connection.

7 segment display	Mode	Description
.."	FBus Status	Slave F-Bus (PROFIsafe/FSoE): Out: Slow flashing: Fast flashing: On: F-Bus does not use F-Bus configured, no connection to the master Connection to the master, F-Bus activation pending F-Bus connected

Table 5: 7-segment display

12.2. Reset behaviour

The Reset function differentiates into a start-up function after voltage recovery (= General Reset) and a status reset / alarm reset (= Internal Reset). The latter is triggered via the button at the front side or via an appropriately configured input (= Reset element) with enabled "Alarm reset" function. The following table offers a survey of the Reset functions and of the effects of the Reset functions.

12.2.1. Types of Reset and triggering events

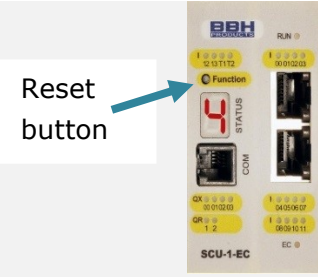
Reset type	Trigger element	Remark
General Reset	Voltage recovery / device start-up	Reset function after the device has been completely switched off and switched on.
Internal Reset		Triggering of the internal reset by means of Reset button on the front-side

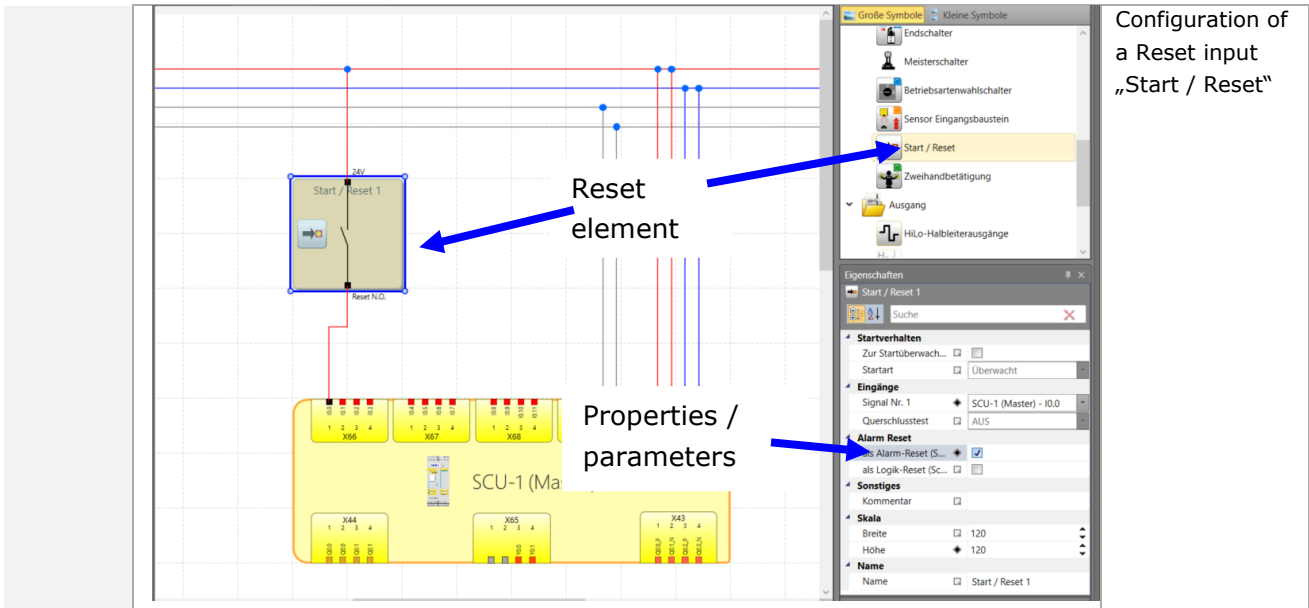

Table 6: types of Reset

12.2.2. Timing of Reset

In the RUN mode, the Reset input for internal Reset is monitored with respect to time. Under the condition $T \leq 3$ sec between the rising edge / the falling edge, an Internal Reset is triggered with the falling edge of the Reset input.

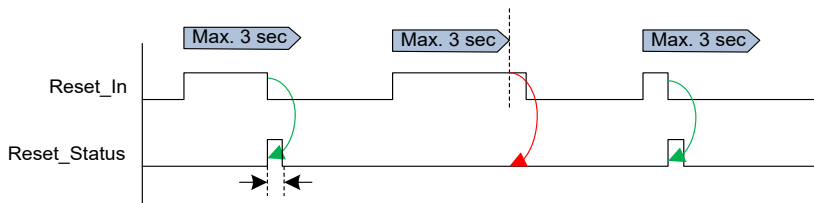

Fig. 40: Timing of Reset

NOTICE

- For time-based functions, the condition $T \leq 3$ sec is only possible by using a block reset.
see SCU Programming Manual, chapter "4.12.2.2"

12.2.3. Reset functions

Function unit	General Reset	Internal Reset	Function
Fatal Error	X		Error reset
Alarm	X	X	Alarm reset
Monitoring functions	X	X	Reset of an addressed monitoring function
Flip-Flop	X	X	Status = Reset
Timer	X	X	Timer = 0

Table 7: Reset functions

After a Reset, the status of the monitoring functions is newly formed.

- ⇒ When exceeding the parametrized limits, process values do not change the initial status of the monitoring function
- ⇒ Time-based function timers provoke a reset of the initial status of the monitoring functions. A response only takes place if the parametrized limit values are once more exceeded.

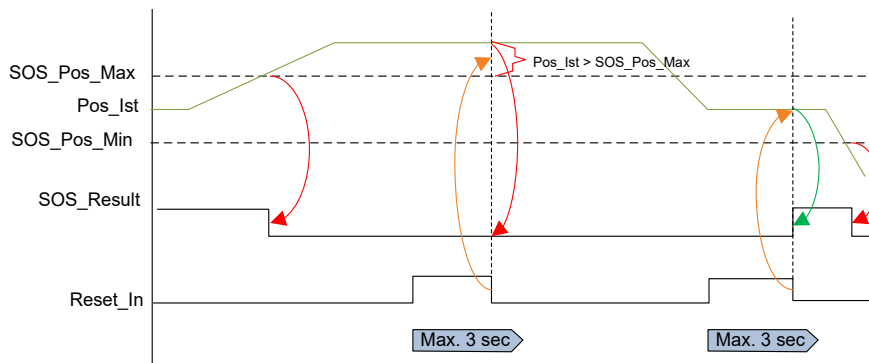

Fig. 41: Reset function 1

Process value (position) => no change of output status at Reset during alarm status

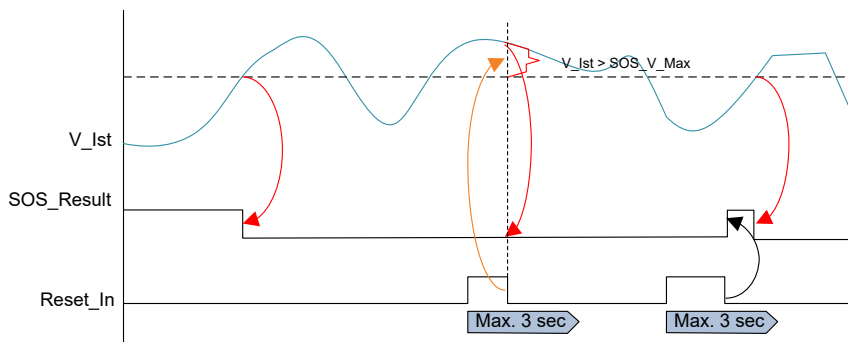

Fig. 42: Reset function 2

Process value (speed) =>no change of output status at Reset during alarm status

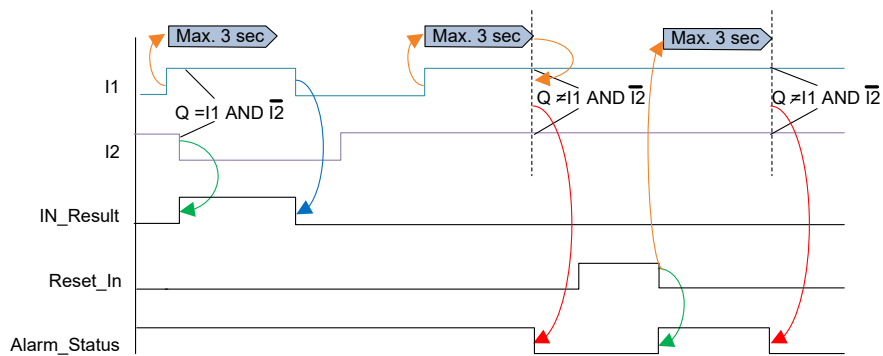

Fig. 43: Reset function 3

Time-based function => reset of output status if limit is exceeded again

NOTICE

- In case of time-based functions (e. g. time monitoring of complementary input signals), the input status is reset. In this case, a status defined as faulty is detected only if the (time) limit value is exceeded again.
- As protective measures against unintended use (e. g. repeated triggering of the Reset function to bypass an alarm status, if need be, applicative measures must be taken in PLC programming.

12.3. LED displays

The SCU unit has 2 LEDs: EC ST and RUN:

LED	Colour	Display	Meaning
EC ST		Off	Init
	Green	Flashing	PRE-OPERATIONAL
	Green	Single Flash	SAFE-OPERATIONAL
	Green	On	OPERATIONAL
	Red	Off	No error
	Red	Flashing	Invalid configuration
	Red	Single Flash	Local error
	Red	Double Flash	Watchdog Timeout
RUN	-	Off	No power supply voltage
	Orange	Flashing	Control is in startup phase, or STOP, or firmware update is carried out.
	Orange	Permant light	Assembly in local mode (without network connection)
	Green	Blinking	Control function correct; applicatoin runs, but has not (yet) been validated.
	Green	Permanent light	Control function correct; application runs and is validated.
	Red	Blinking	Alarm (application error) – the assembly is in safe operating state. Error status can be reset
	Red	permanent light	Fatal error – the assembly is in safe operating state.

Table 8: LED displays

NOTICE For all operating states except RUN, the displays are passivated by the firmware, i. e., the displays are safely disconnected. In the RUN status, the status of the plant depends on the implemented PLC program.

12.4. Parametrization

Parametrization is carried out via the program SafePLC².

To be able to send the data to an assembly, a programming adapter is needed. The driver of the programming adapter must first be installed by the user. Parametrization is described in the Programming manual.

12.5. Regular function test

To grant the safety of the assembly once a year a function test of the safety functions must be carried out. In this function test, the blocks (inputs, outputs, monitoring functions and logic modules) must be tested with respect to their function, or rather, with respect to their disconnection.

12.6. Validation

Every safety function must be validated after implementation to grant its correct functioning and its reliability. Validation of safety functions takes place on different levels. Validation is explained in a more detailed way in the standard EN 13849-2:

- ➔ Validation of the safety function in the programming tool
- ➔ Additional validation of the safety function on the finished machine
- ➔ Carrying out of function tests with respect to the diagnostics measures and with respect to the shut-off functions in the event of a fault or a failure
- ➔ Carrying out of error detection procedures. Thus, also correct wiring of the machine can be tested.

Besides the function test, validation of safety-relevant controls also includes a detailed analysis, and, if need be, error simulations.

To be able to recognize problems at an early stage, this analysis should take place at the beginning of the design process.

The scope of the analyses and tests carried out during the validation depends on the complexity of the control system and its integration into the machine or plant.

For validation a validation plan must be created. Depending on the complexity of the control to be tested, or depending on the machine, the validation plan contains the following information:

- Requirements for the implementation
- Operating conditions and ambient conditions
- Basic and reliable safety principles
- Reliable components
- Error presumptions and error exclusions
- Applied analyses and applied tests

To preserve the capacity of safety-relevant controls and to grant the safety, regular maintenance and repair with periodic tests is necessary. The periodic tests should be listed in the validation plan.

12.6.1. Process

To guarantee the functioning of the implemented safety functions, after start and parametrization, the user must test the parameters and the connections, and he must document the test. Test and documentation of the parameters and of the connections is supported by the software SafePLC² in the form of a configuration report.

The concept of the **SCU-x-EC** assumes the following basic conditions:

Parameter data and PLC data that are deposited in the flash of the **SCU-x-EC** cannot change on their own. This is ensured by online tests and the corresponding signatures in the course of basic measures.

Nevertheless, the configuration in itself cannot be rated by the **SCU-x-EC**. This concerns the parametrization of the sensors, of the threshold values and of the limit values.

To ascertain the correctness of the parametrization, the parametrization must be verified by an expert. This verification corresponds to the validation.

After a successful start, the user must confirm that the data of the configuration report coincide with the parameters on the **SCU-x-EC**.

In the course of a function test the parametrized individual values for the calibration distance, the sensors and the monitoring functions must be verified and recorded by the user.

Furthermore, the programmed PLC functions must be verified and recorded by the user for every connection in terms of a code inspection. For this purpose, it is recommended to design the control so that the limit values of the **SCU-x-EC** can be tested.

12.6.2. Configuration report

The validation of the safety assembly is carried out by means of a configuration report.

12.6.2.1. Structure of the configuration report

The configuration report contains the following data:

- A header section that contains checksums and boxes to insert general project data
- A section with the list of the IL commands (PLC code)
- A survey of the inputs and the outputs used and of their parametrization
- All monitoring functions used and their parameters

12.6.2.2. Creating a configuration report

Via the connection dialog of the parametrizing software SafePLC² a configuration report of the connected device can be produced.

For the production of a configuration report, the necessary data are downloaded from the connected device, and are stored legibly in a *.pdf document. The user can determine the memory location while creating the document.

The respective boxes can be filled in directly in the PDF documents. Validation can also be carried out by means of a print of the configuration report.

12.6.2.3. Filling in the configuration report

The configuration report is filled in the following way:

- ➔ Enter the plant-specific data in the "Header" section. The plant-specific data are informative, but their content and their volume should both be coordinated with the acceptance authority / with the tester.
- ➔ Set all hooks in the Header section if all displayed data (serial number, device type, CRC of the configuration) are identical with the data of the assembly.
- ➔ Validate the PLC user program and make sure that the code that has been filled in corresponds to the specific function.
- ➔ Set the hook in the inputs / outputs section for every entry that coincides with the rals connection of the **SCU-x-EC**.
- ➔ Set the hooks for all safety functions (e. g. SLS, SCA, etc.) if the set parameters coincide with the requirements.

NOTICE

- ➔ To create the configuration report for validation, the correct program data and the correct parameter data must be loaded.
- ➔ All listed parameter instructions and all listed program instructions must be validated at the plant / at the machine and must be confirmed in the configuration report.

- ➔ The tester must validate all configured data in the configuration report by checking all set limit values of the monitoring functions used are checked by means of a function test.

The practical procedure of validation should be carried out directly on the machine or plant to be protected. At least the following documents should be available for the validation:

- ➔ Operating instructions of the machine or plant with warnings
- ➔ Circuit diagram of the entire control system
- ➔ Documentation of the planning of the safety-related part of the plant as described above.
- ➔ Configuration report in electronic or printed form

The specific procedure should be based on the following guidelines:

- The connected components such as control devices, sensors and actuators should be checked for correct connection. This check should be done primarily by actuating / stimulating the sensors and checking in the status display (diagnostics) of the safety controller.
- When using diagnostic functions e.g. pulse assignment, a check should be carried out e.g. by short-circuiting him pulses etc.
- If safety functions are used which are based on speed and/or position data, the correct recording of the speed or position must first be checked. The check is possible e.g. by the diagnostic function for speed and position which can be selected in the SafePLC. Here the displayed velocity / position is to be checked by a physical measurement with a suitable device. This test must be carried out in any case and is a prerequisite and cannot be replaced by a theoretical test.
- It is recommended to also check the diagnostics of the speed and position sensors. This can be done, for example, by disconnecting a sensor or a track of a sensor.
- The logic functions should be checked in relation to the planning specifications. This should be done primarily by appropriate stimulation of the inputs etc. and the effect checked e.g. activation of a monitoring function or also deactivation of an output.
- The set parameters of monitoring functions should not only be checked for compliance with the planning specifications, but also as far as possible by exceeding the parameterized limit value and observing the reaction.

13. Safety inspection

To ensure the functioning of the implemented safety functions, after start and parametrization the user must check the parameters and the connections, and he must document the check. Check and documentation are supported by the software SafePLC² (cf. Programming manual SCU).

On the first two pages of the validation reports, general details concerning the plant can be entered.

On the following pages of the validation report, all functions used are printed with their parameters as itemization of the safety inspection.

After the configuration data and the program data have been transmitted to the SCU assembly, the status LED blinks yellow. This indicates that the configuration has not yet been validated.

By confirming the button "KONFIGURATION SPERREN" [BLOCK CONFIGURATION] at the end of the validation dialog, the data are made as "Validated" and the LED blinks green.

14. Maintenance

The SCU assembly is maintenance-free.

15. Failure and troubleshooting

If the SCU assembly does not work properly, it autonomously changes into the safe status and displays the fault state via LED (cf. chapter 11.3 LED displays).

Please, check the displayed error code (7-segments display) by means of the SCU error list (error codes and measures).

Should it not be possible to eliminate the error status, please contact the manufacturer immediately (cf. "Manufacturer").

16. Replacing an assembly

DANGER



Work on the wiring or work at the electrical system can cause electric shock. Electric shock can cause death. Thus, only persons qualified according to TRBS 1203 may carry out work on the wiring or work on the electrical system.

Repair

Assemblies must always be replaced completely.

Repairs can and may only be carried out in the factory.

Warranty

Warranty expires if the assembly is unduly opened.

NOTICE

If the assembly is modified, the safety authorisation expires!

NOTICE

When changing an assembly, you should proceed as follows:

- Disconnect the current converter(s) from the main supply
- Switch off the power supply for the device and disconnect the connection
- Unplug the encoder plug.
- Remove all other pluggable connections.
- Take the assembly off the top-hat rail and pack it according to EMC standards.
- Fix a new assembly on the top-hat rail.
- Restora all connections.
- Switch on the current converter(s).
- Switch on the power supply.
- Configure the device.

17. Decommissioning / disassembly / disposal

DANGER



Work on the complete plant and work on the SCU may only be carried out by a trained electrician. This trained electrician must be a qualified person according to TRBS 1203. Before disassembly the machine must be in rest position. Power supply must be completely switched off and completely disconnected.

In case of final decommissioning, the whole plant must be secured mechanically. Afterwards, the plant and its components must be marked so that recommissioning is not possible. Decommissioning must be mentioned in the documentation.

After its final decommissioning, the complete plant can be disassembled. The plant and their components (e. g. the joining module) contain valuable raw materials. Thus, the plant and its components must be recycled separately by an appropriately specialised company.

Disassembly Is carried out analogous to chapter 15 "Replacing an assembly".

Disposal:

NOTICE:

Please observe the national regulations concerning the disposal of electrical devices.



The symbol of the crossed out garbage bin signifies that electric devices and electronic devices including their accessories must be disposed of separate from domestic waste.

The materials are reusable according to their label(s). By reusing or recycling materials or by other ways of recycling old equipment, you make an important contribution to the protection of our environment.

If necessary, dispose of the components separately according to their nature. Always dispose of the components according to the regulations valid in the respective country, e. g. as:

- Electrical waste
- Artificial sheet metal
- Sheet metal
- Copper

18. Setting as EtherCAT Slave with TwinCAT3

Furthermore, in the EtherCAT network the FSoE Master must be parametrized as Slave. For EtherCAT Master by Beckhoff, this setting can be carried out with the program **TwinCAT3** (by Beckhoff).

The necessary steps are described hereafter.

18.1. Installing the program

First, the program must be installed completely.

For program installation, Beckhoff provides the following installation program:

TC31-Full-Setup.3.1.4020.0.exe

By calling up the program, the program is installed automatically.

Please follow the instructions and complete the installation.

18.2. Creating a new project / Creating a new EtherCAT network

First, the program TwinCAT3 must be started. The program TwinCAT3 can be started via the start menu.

START -> Beckhoff -> TwinCAT3

Afterwards, a new project (a network) can be created via the following path:

File -> New project -> TwinCAT XAE Project (XML format)

For this project, a name and a memory location must be specified.

The following window appears:

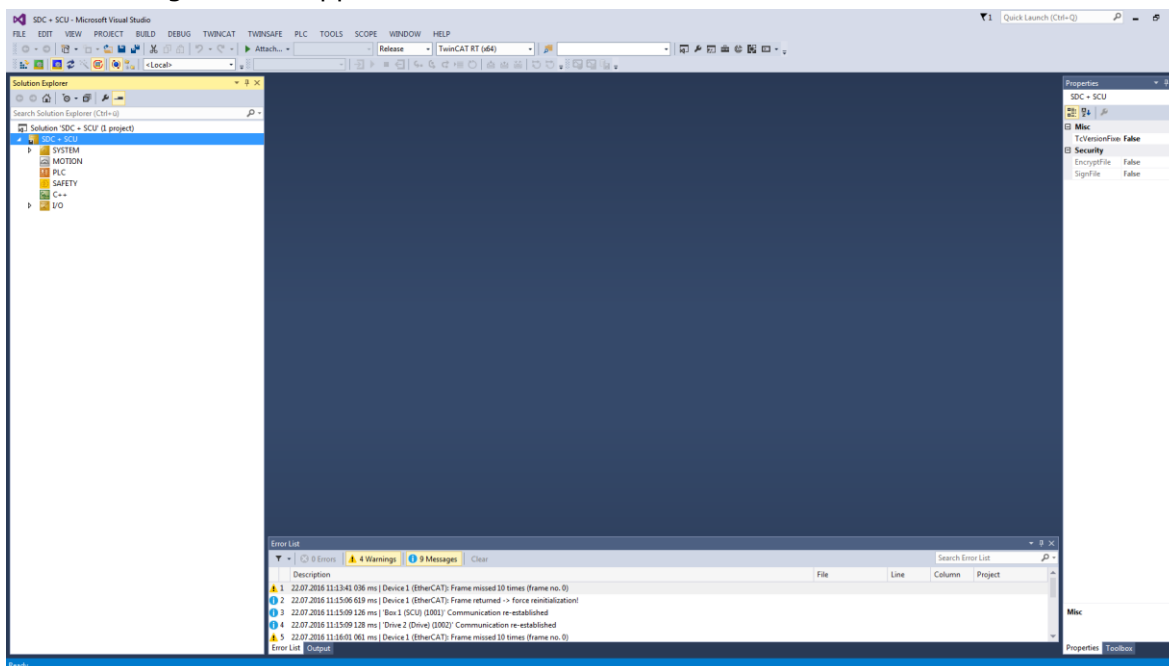

Fig. 44: starting TwinCAT

Please insert the real-time capable devices, and check the insertion via the menu
TWINCAT -> Show Realtime Ethernet Compatible Devices...

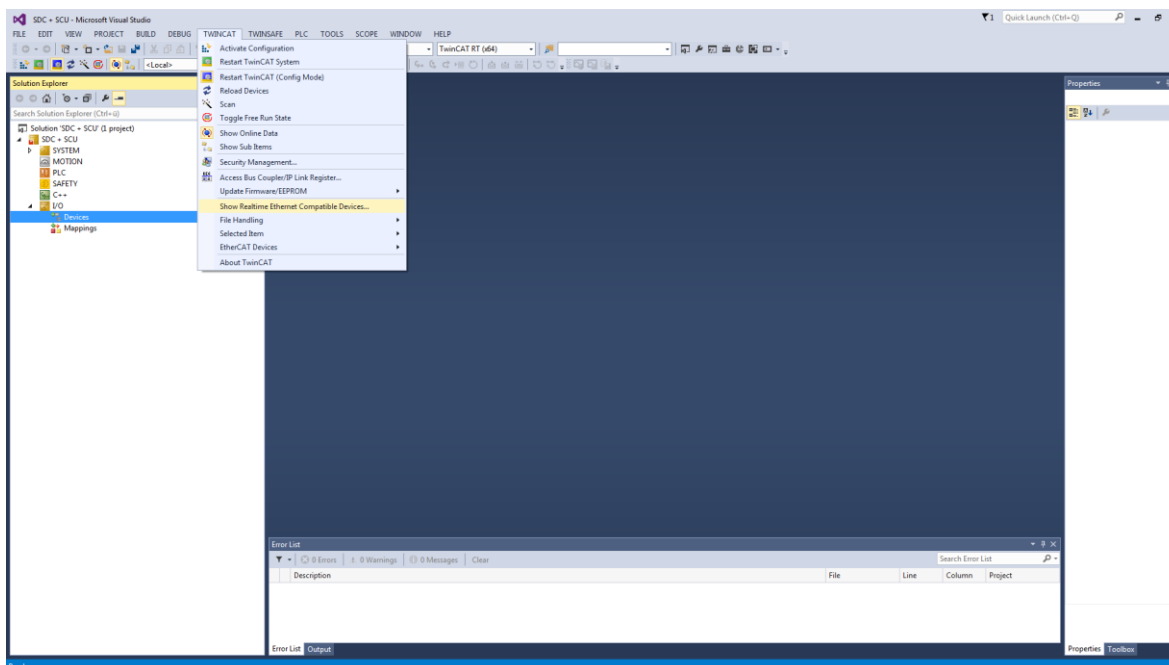

Fig. 45: TwinCAT – Geräte einfügen [TwinCAT - insert devices]

Please, first insert the EtherCAT Master.

To insert the EtherCAT Master, use the option "neue I/O-Geräte einfügen" [insert new I/O devices] via the following menu:

I/O -> Devices click< right mouse button> -> Add new items

There, please select the Master assembly.

Then the following window appears:

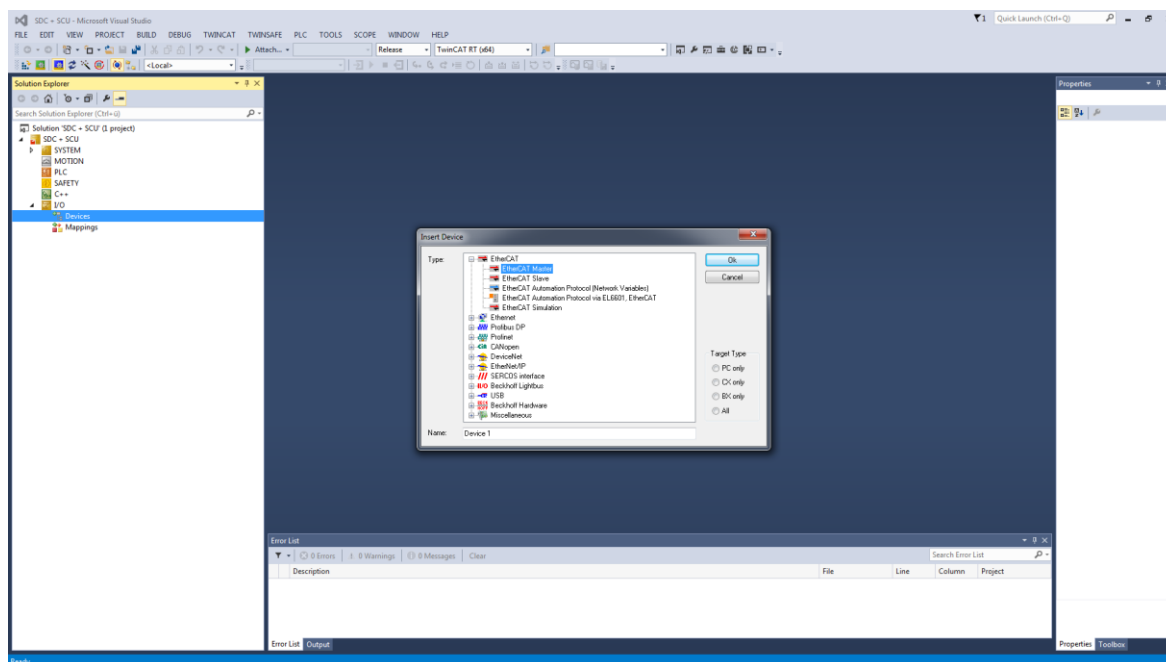

Fig. 46: TwinCAT - Master einfügen [TwinCAT – insert Master]

To insert EtherCAT Slaves (e. g. the assemblies manufactured by BBH), please use the menu

I/O -> Devices -> Device1 (EtherCAT) click <right mouse button> klicken -> Add new items -> BBH Products GmbH -> SCU -> SCU

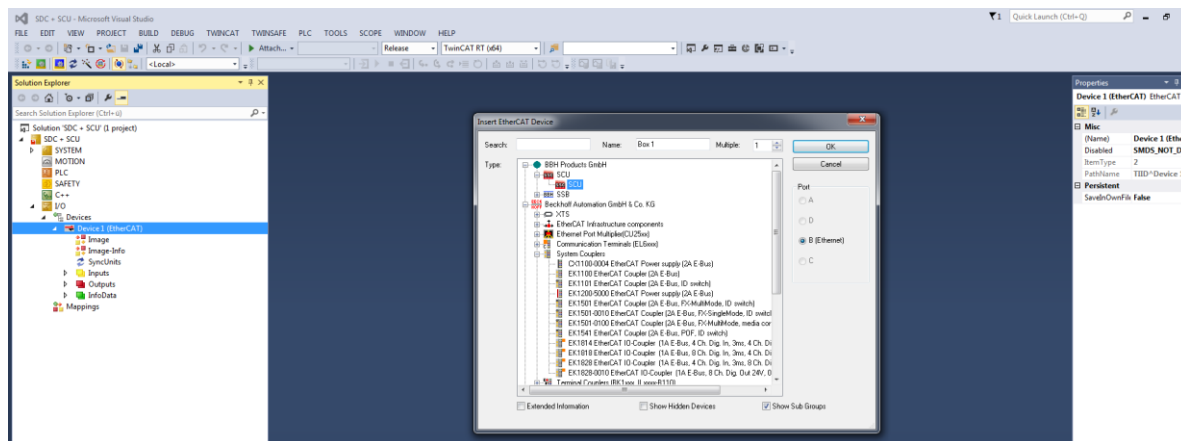

Fig. 47: TwinCAT – SCU einfügen [TwinCAT - insert SCU]

To insert additional EtherCAT Slaves, please use the menu – as shown with the example *LTi-Servo One CM – axle module*

I/O -> Devices -> Devices1 (EtherCAT) click <right mouse button> -> Add new items -> LTI DRIVES GmbH -> ServoOneCM -> 3 Axis module

The selected module is parametrized by inserting "Slots" in the SCU assembly.
To insert "Slots" in the SCU assembly, please <double click> on the SCU assembly.
Select the Slot table and afterwards **10 Bytes In / 10 Bytes Out** in Slot 1, Slot 2 and Slot 3.

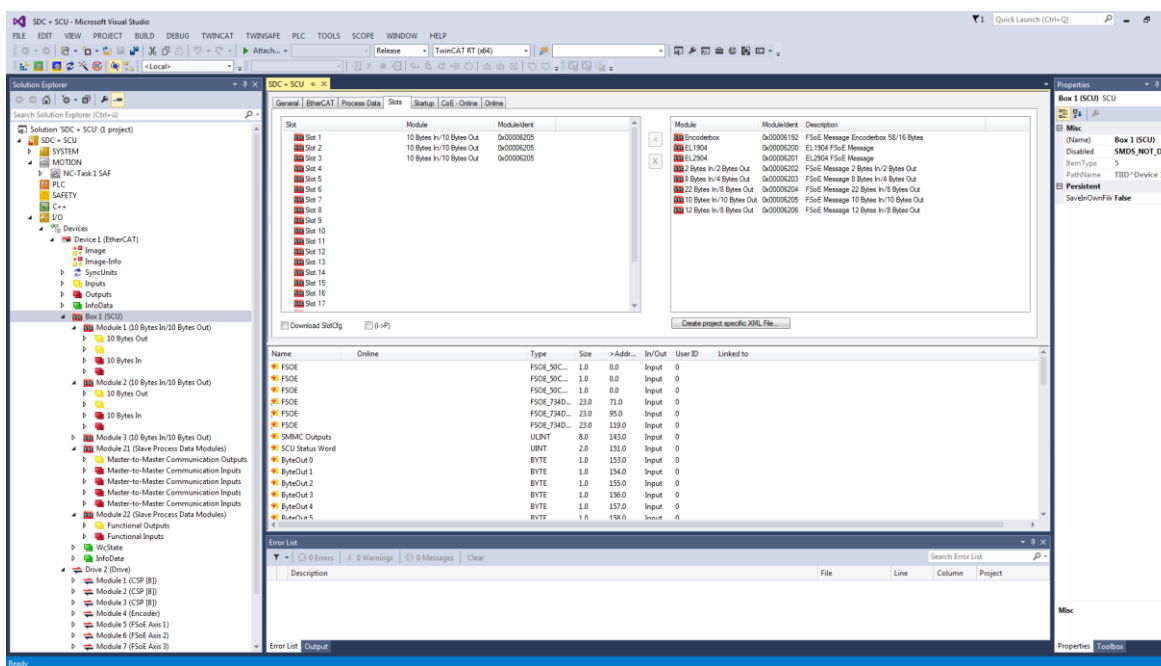

Fig .48: TwinCAT – IO devices

The respective Slots are parametrized via

I/O -> Devices -> Drive 2 (Drive) <double click> -> Process Data Tab -> PDO Assignment

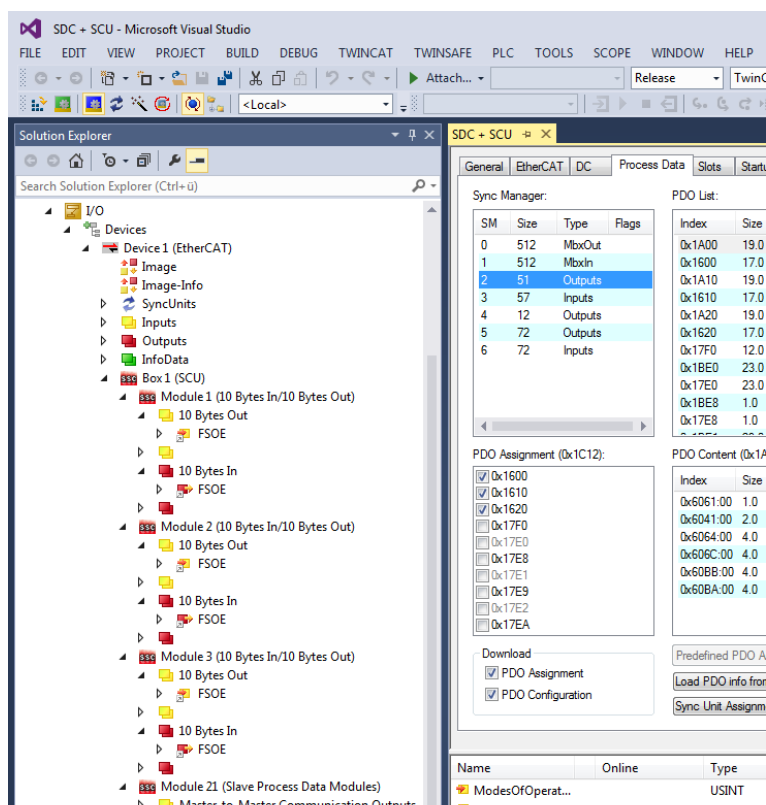

Fig. 49: TwinCAT – IO devices

There, the following settings must be made

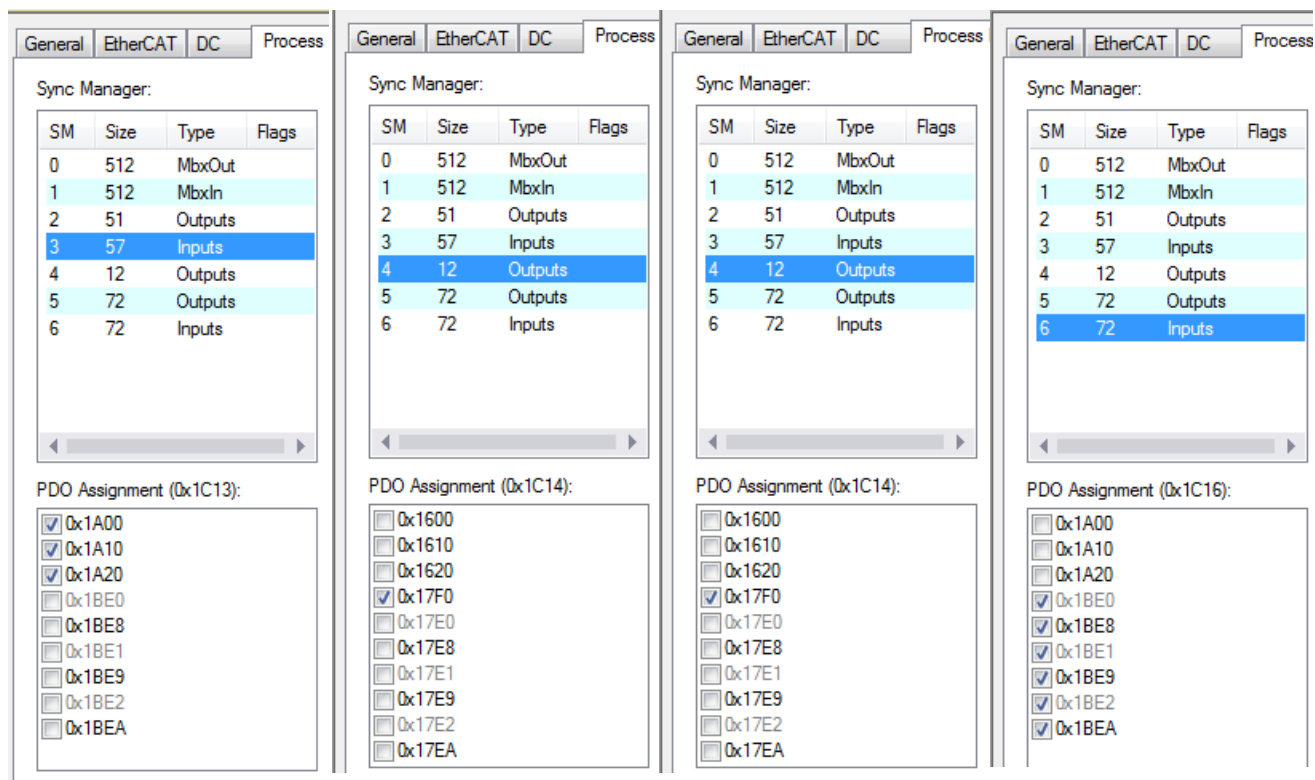

Fig. 50: TwinCAT – setting Slaves

The linking of the inputs and the of the outputs of the two devices must be set as follows:
Inputs from Box 1 (SCU) < -> Outputs from Drive 2 (Drive)
Outputs from Box 1 (SCU) < -> Inputs from Drive 2 (Drive)

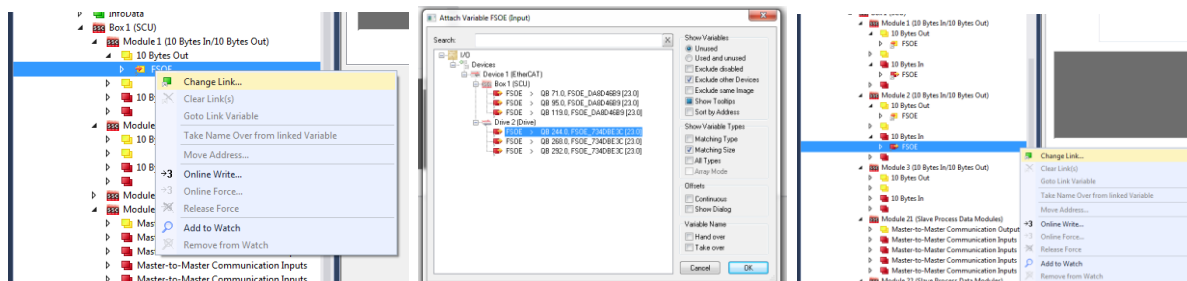
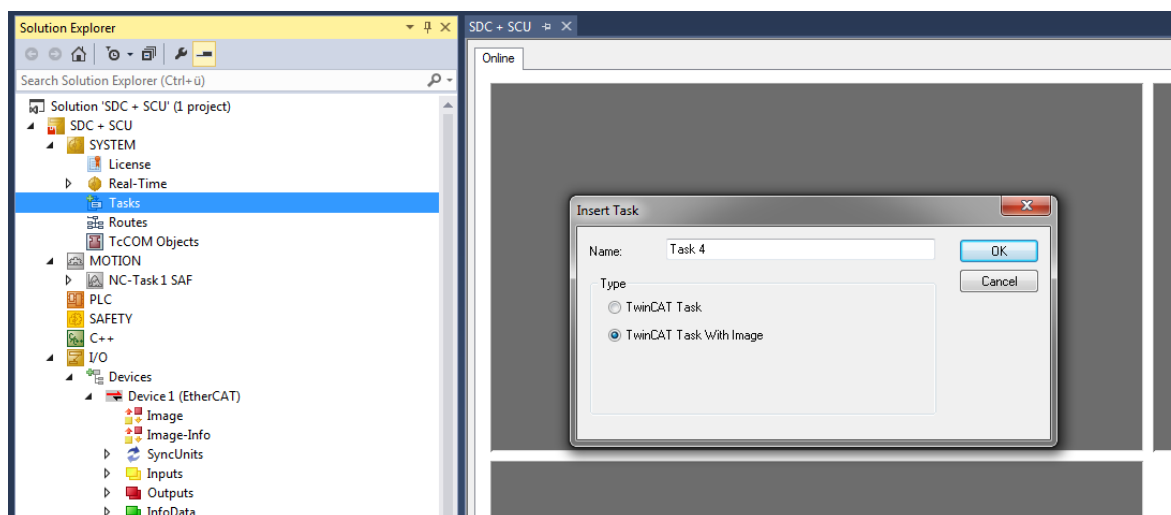

Fig. 51: TwinCAT - linking

The SCU assembly is inserted via the menu:

SDC + SCU -> SYSTEM -> Tasks -> Add New Items



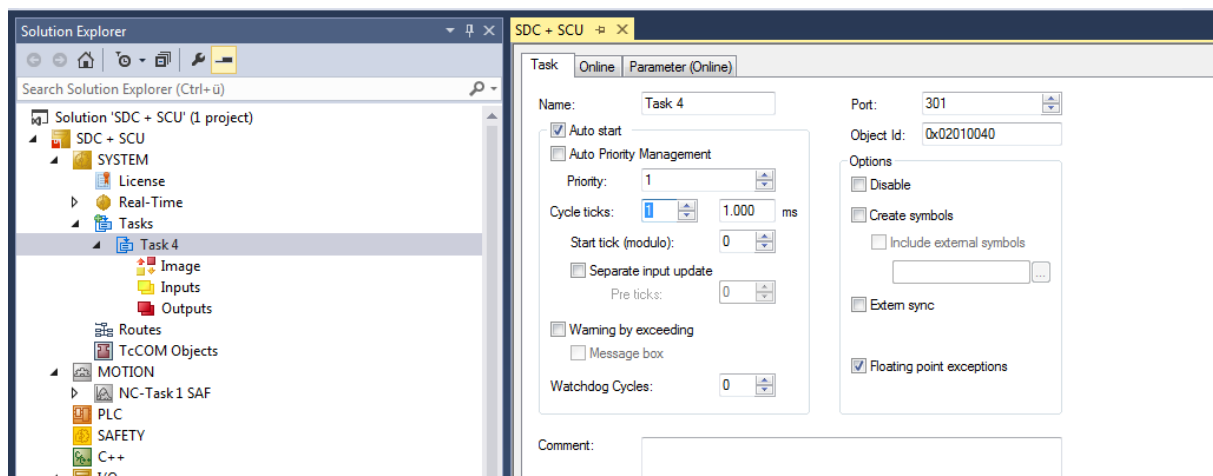

Fig. 52: TwinCAT – insert SDC

SDC + SCU -> SYSTEM ->Tasks -> Task 4 -> Inputs -> Add New Items

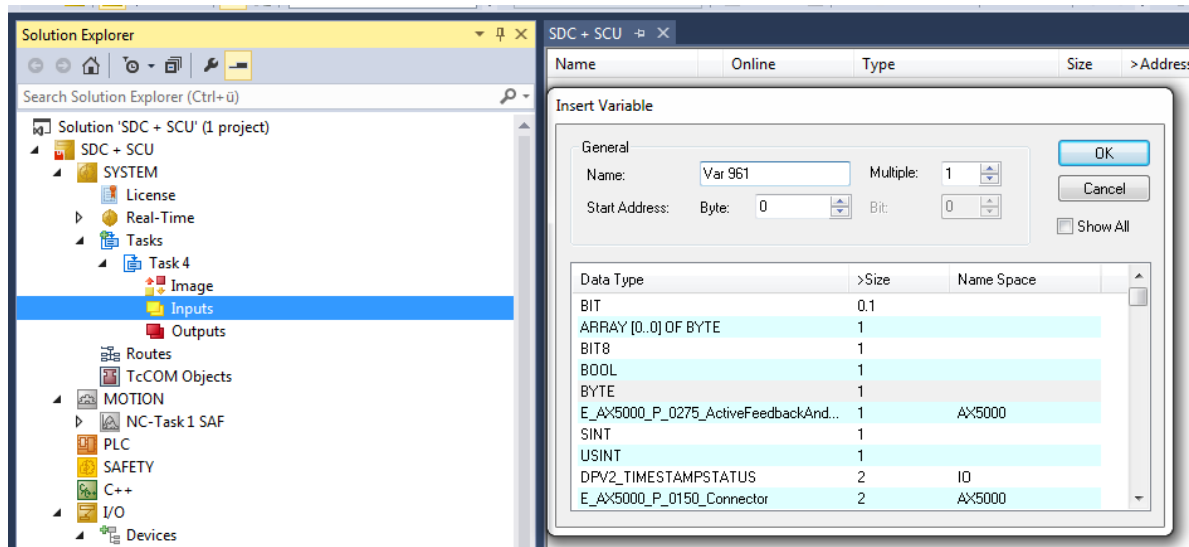

Fig. 53: TwinCAT - Task

The parameters are set via:

SDC + SCU -> SYSTEM ->Tasks -> Task 4 -> Inputs -> Var 961 -> Change Link.

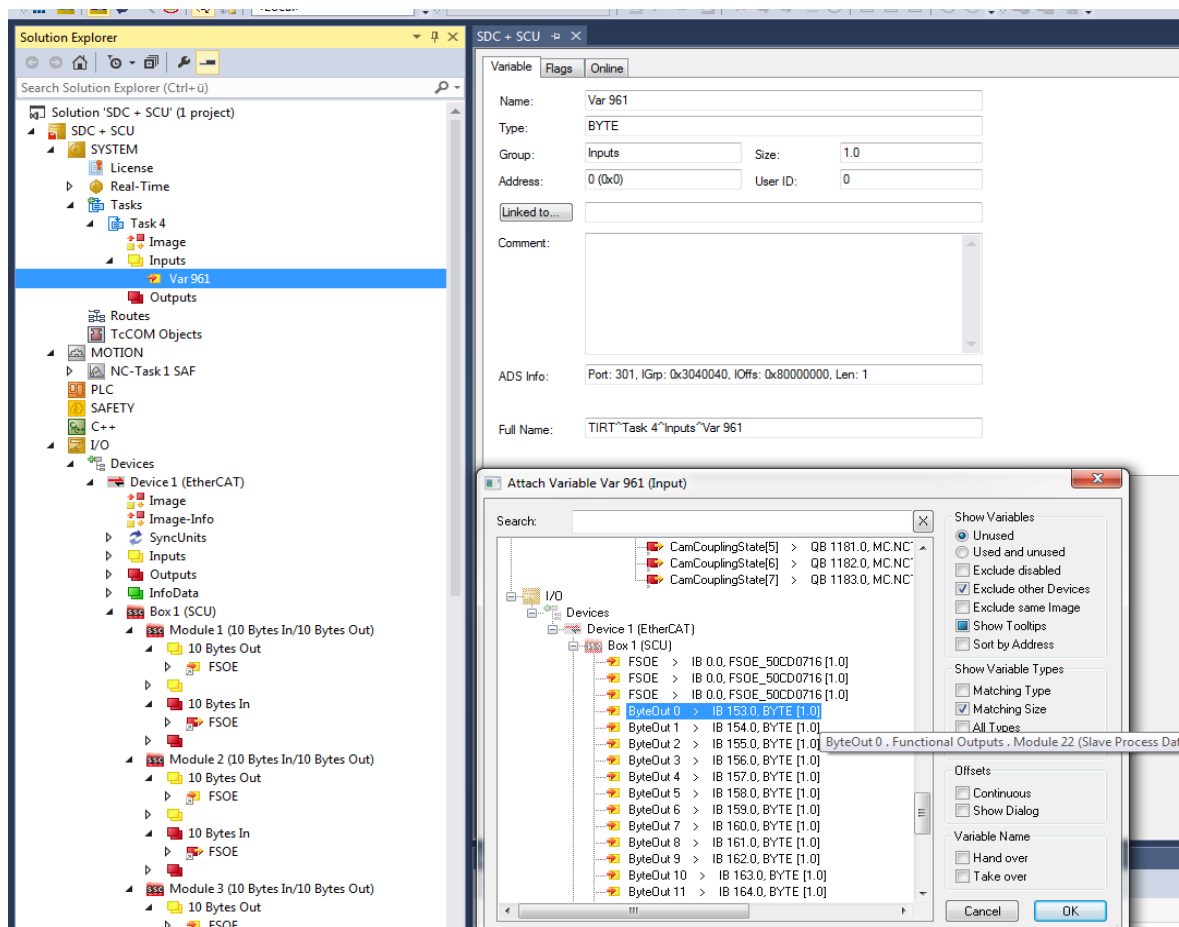

Fig .54: TwinCAT connection

Setting the time parameters:

I/O -> Devices -> Device 1 (EtherCAT)

In the adapter table, the value for the Freerun Cycle must be set to 1ms.

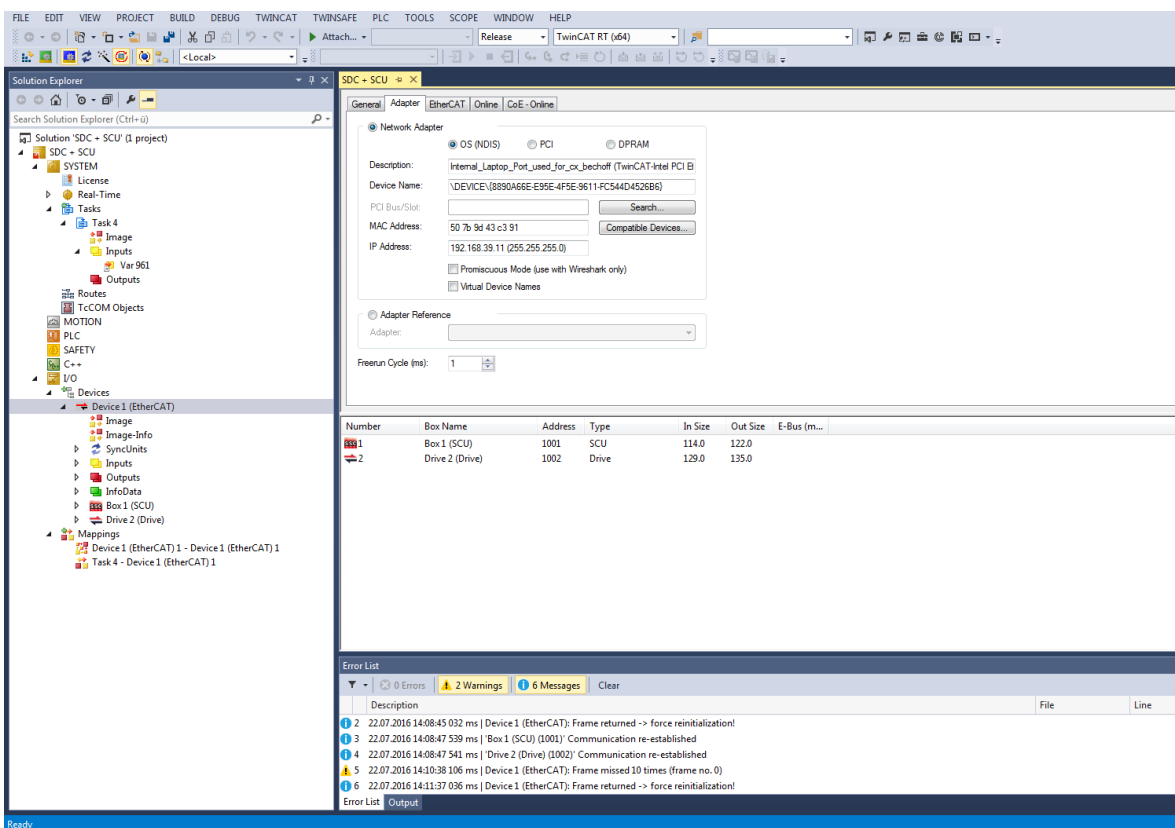

Fig. 55: TwinCAT – time parameters

Finally, please reload the device, and activate Free run aktivieren, wenn nun Danach läuft das FSoE-Netzwerk („RUN“) und die Geräte müssen in den Status „OP“ wechseln.

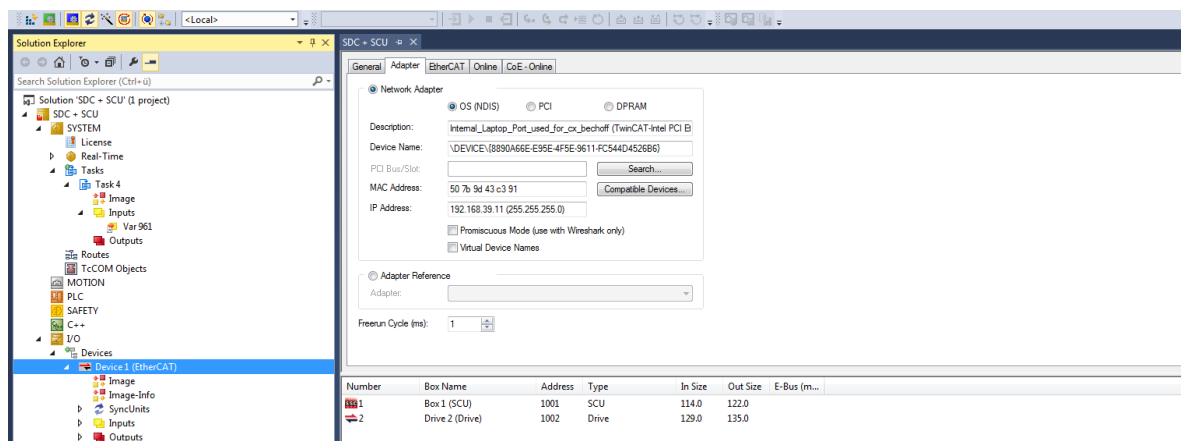

Fig. 56: TwinCAT – RUN

18.3. EoE settings in TwinCAT (EtherCAT settings)

To carry out the EoE settings, the virtual Ethernet Switch must be enabled (Enable Virtual Ethernet Switch):

I/O -> Devices -> Device1 (EtherCAT) -> Open the EtherCAT tab -> Advanced Settings... -> EoE Supprt

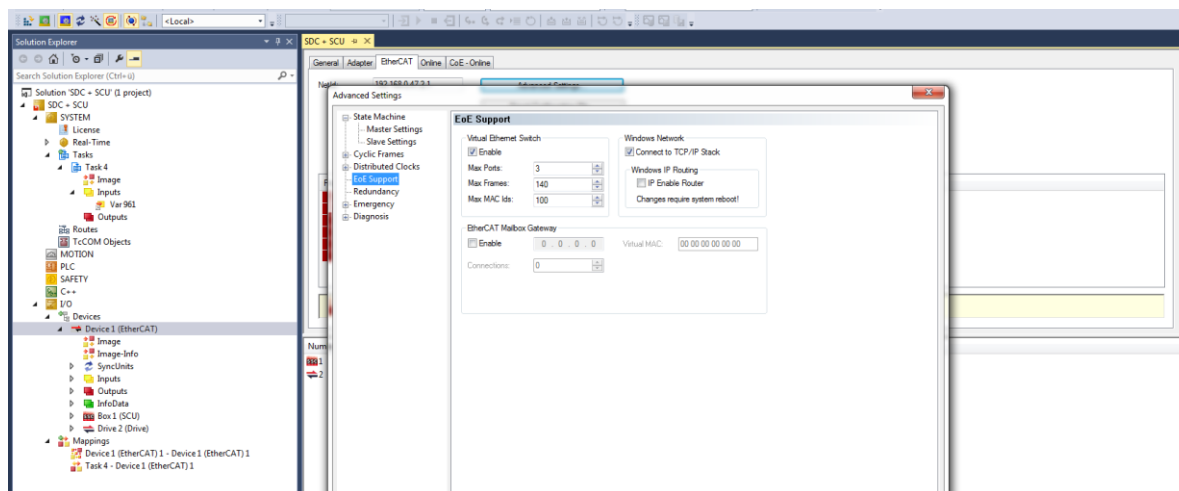

Fig 57: TwinCAT – EoE settings

Then set the IP ports:

I/O -> Devices -> Device1 (EtherCAT) -> Drive 2 (Drive) and Open the EtherCAT tab-> Advanced Settings...-> Mailbox EoE

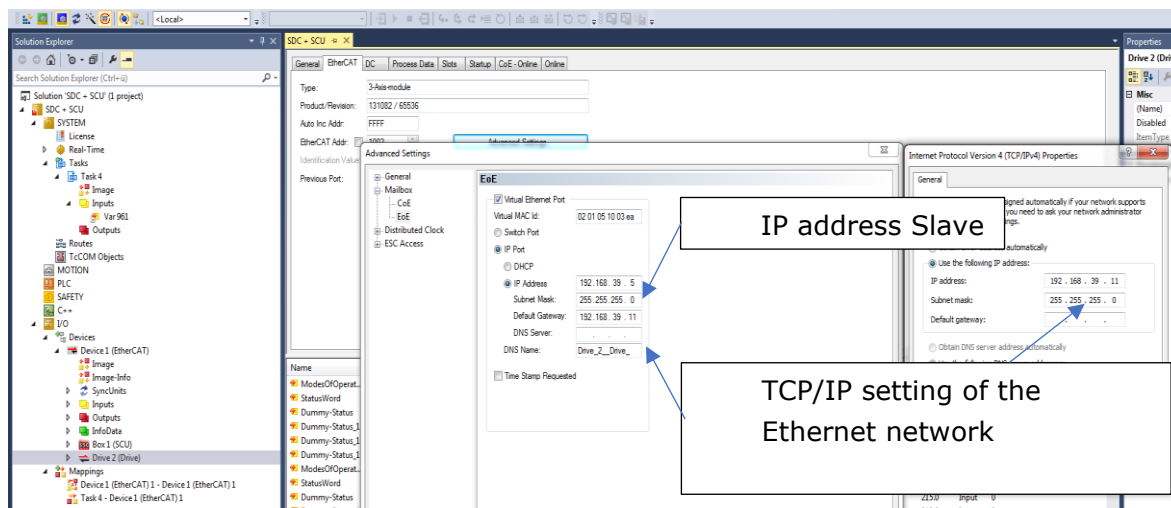

Fig 58: TwinCAT – IP ports

Afterwards, the pinging (testing) of the Slave carried out (with FSoE being enabled):
RUN -> cmd -> ping 192.168.39.5

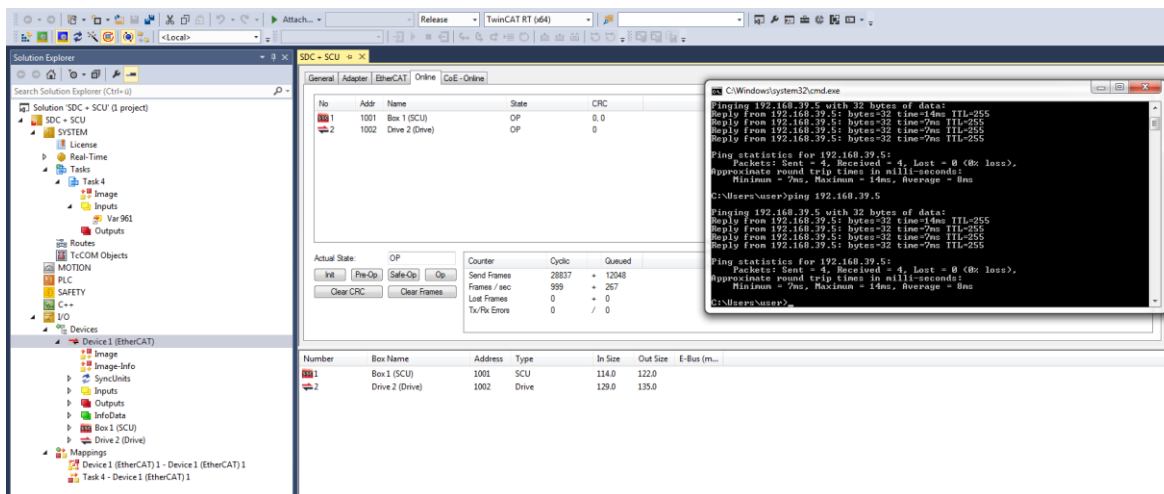

Fig 59: TwinCAT – pinging of the Slaves

Finally, SafePLC² can be connected with the program, if FSoE is enabled.

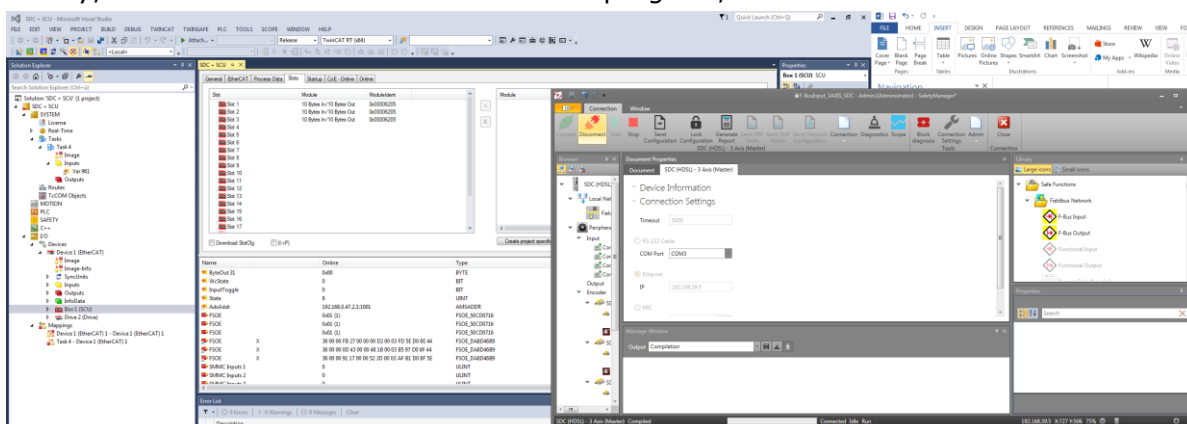

Fig 60: TwinCAT + SafePLC2

19. Information for design, programming, validation and test

The following information describes the procedure for design, programming, validation and test of safety-related applications.

The information shall help the user to classify all steps from risk analysis to the system test, to easily understand these steps, and to apply these steps

19.1. Risk analysis

In principle, the manufacturer of a machine must warrant the safety of a machine he manufactured or delivered. For safety evaluation, the respective valid relevant directives and standards must be consulted. The objective of the safetyreview and of the measures resulting thereof must be to reduce danger to persons to an acceptable level.

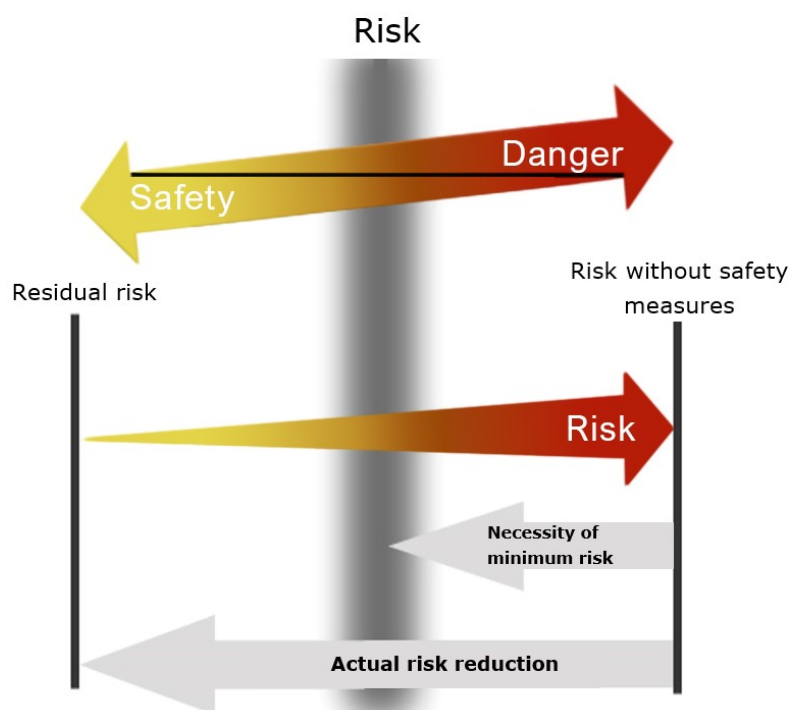

Fig 61: risk analysis

The risk analysis must consider all operating conditions of the machine, e. g. operation, setting-up and maintenance or installing and decommissioning as well as foreseeable misuse of the machine.

The necessary method for risk analysis, and the measures for risk reduction are contained in the relevant standards, e. g.

- EN ISO 13849-1 Sicherheit von Maschinen
- EN ISO 61508 Funktionale Sicherheit sicherheitsbezogener e/e/p E-Systeme.

Risk evaluation according to EN ISO 13849-1

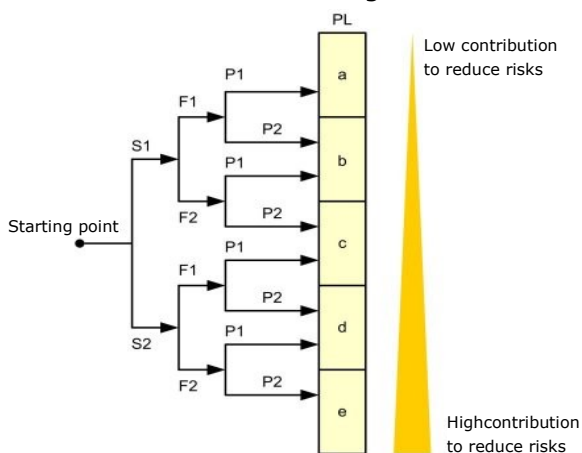

- S – Serve physical injury
- S1 = minor, reversible injury
- S2 = severe, irreversible injury

- F – Frequency and/or duration of Exposure to danger
- F1= rarely, not cyclic
- F2 = frequently up to permanent and / or long duration, cyclic operation

- P – Possibility of risk prevention
- P1 = possible, slow movement / slow acceleration
- P2 = hardly possible, high acceleration in the event of a fault

Fig 62: risk graph according to EN 13849-1

Risk evaluation according to EN ISO 61508

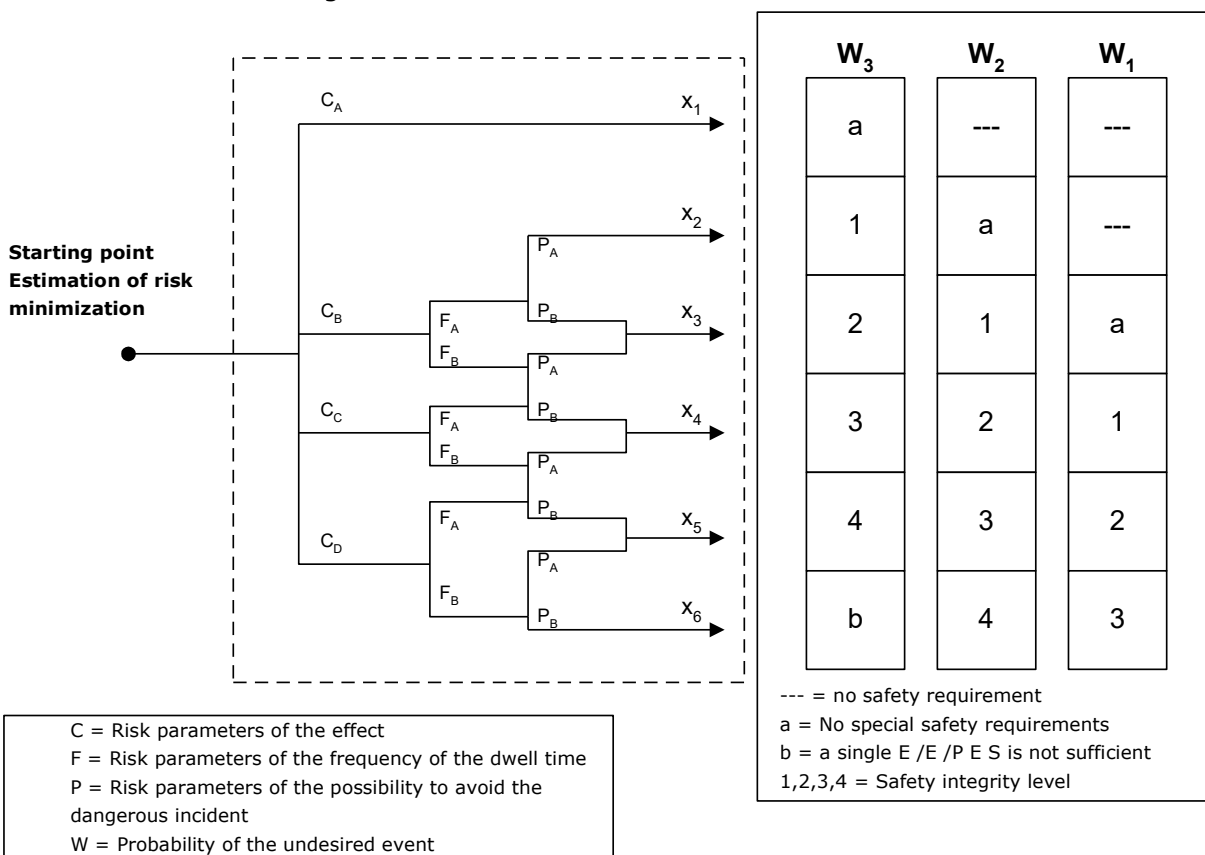

The risks to be considered are also contained in the relevant directives or standards, or rather, the risks to be considered must be considered separately by the manufacturer due to his specific knowledge of the machine.

For machinery put into circulation within the EU, the minimum risks to be considered are specified in the EU Machine Directive 2006/42/EG, or rather, In the latest version of this directive.

Further information concerning risk evaluation and the safe design of machinery is contained in the standards

- ISO/TR 14121-2 Safety of machinery – Risk assessment,
- EN 12100 Safety of machinery – basic concepts.

Measures applied to reduce identified risks must be at least on the same level as the risk. Such measures and the requirements for these measures are exemplified in the directives and standards mentioned above.

19.2. Necessary technical documents

Various technical documents must be supplied by the manufacturer.

Their minimum scope is also included in the relevant directives and standards.

For example, according to the EU Machinery Directive, the following documents must be supplied at a minimum:

1. The technical file shall comprise the following:
 - a) a construction file including:
 - a general description of the machinery,
 - the overall drawing of the machinery and drawings of the control circuits, as well as the pertinent descriptions and explanations necessary for understanding the operation of the machinery,
 - full detailed drawings, accompanied by any calculation notes, test results, certificates, etc., required to check the conformity of the machinery with the essential health and safety requirements,
 - the documentation on risk assessment demonstrating the procedure followed, including:
 - i) a list of the essential health and safety requirements which apply to the machinery,
 - ii) the description of the protective measures implemented to eliminate identified hazards or to reduce risks and, when appropriate, the indication of the residual risks associated with the machinery,
 - the standards and other technical specifications used, indicating the essential health and safety requirements covered by these standards,
 - any technical report giving the results of the tests carried out either by the manufacturer or by a body chosen by the manufacturer or his authorised representative,
 - a copy of the instructions for the machinery,
 - where appropriate, the declaration of incorporation for included partly completed machinery and the relevant assembly instructions for such machinery,
 - where appropriate, copies of the EC declaration of conformity of machinery or other products incorporated into the machinery,
 - a copy of the EC declaration of conformity;
 - b) for series manufacture, the internal measures that will be implemented to ensure that the machinery remains in conformity with the provisions of this Directive.

Fig. 63: technical documents according to the Machine Directive

Source: BGIA Report 2/2008

The documents must be easy to understand, and they must be written in the respective national language.

19.3. Necessary steps – design, realization and test

The implementation of plant components requires special diligence with respect to design, realization and test. Also for these aspects, guidelines are contained in the relevant standards (cf. EN ISO 13849-2 or rather, EN ISO 61508).

The effort for the implementation of plant components depends on the complexity of the task for plant components with safety functions.

When it comes to realizing such functions by means of safety-relevant control functions and safety-relevant monitoring functions, the SCU series offers efficient support in the form of the system's architecture (architecture cat. 4 according to EN ISO 13849-1), and above all in the form of the programming language and in the form of tested safety functions. Programming takes place in FUP (function-plan oriented programming). FUP is the form of programming that is recommended in the safety standards. Furthermore, FUP meets the requirements of a programming language with a limited language range (LVL) for which essentially there apply simplification in documentation and in the test range. In every case the single steps require careful planning and analysis of the methods and systems used. The particular steps must be documented in a well comprehensible way.

V model (simplified):

The implementation of safety-related function requires a structured method as it is exemplified in the V model that is recommended in the relevant standards. Subsequently, the method in case of applications with assemblies of the SCU series is exemplified:

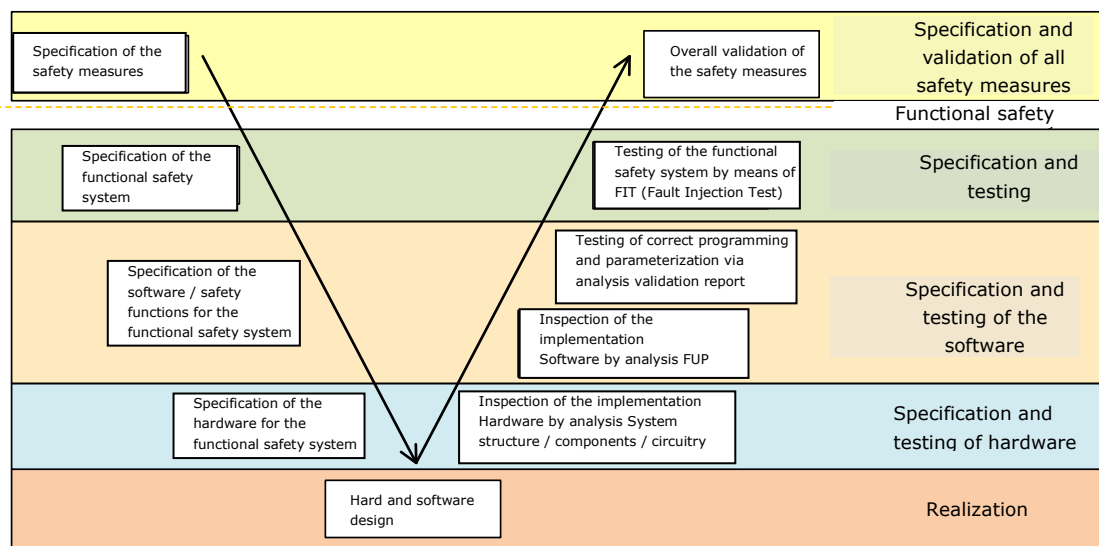

Fig. 64: V model

Phases of the V model:

Name	Description	
	Design phase	Validation phase
Specification and validation of all passive safety measures and of all active safety measures.	Specification of all applicable safety measures, e. g. covers, enclosures, max. machine parameters, safety functions etc.	Test of all passive safety measures and of all active safety measures for correct implementation and for efficiency
Specification of the functional safety systems	Specification of the active safety systems an assignment of the active safety systems to the risks to be reduced, e. g. reduced speed in set-up mode, stop mode, monitoring of access areas etc. Specification of the PLr , or rather, of the required SIL for every particular safety function	Test of all active safety systems for efficiency and for observance of the specified parameters, such as e. g. correct speed, correct stop, response of monitoring devices etc. by means of practical tests.
Specification of the software / specification of the safety functions	Specification of the functionality of the particular safety functions and definition of the de-energizing circuit etc. Definition of the parameters for the particular safety functions such as e. g. max. speed, stop ramps, and stop categories etc.	Prüfung der korrekten Umsetzung der Funktionsvorgaben durch Analyse FUP-Programmierung Validation of the application program and validation of the paramters by comparison of the validation report to the FUP, or rather by comparison of the validation report to the requirements for the parameters
Specifiation of the hardware	Specification of the plant structure and of the functions of the different sensors, control devices, control components ad actuators with respect to their safety functions	Check of the correct implementation of the specifications Determination of the failure probability, or rather, determiantion of PL by means of analysis of the total architecture and of the identification data of all components involved, always related to the particular safety functions
Hardware design and software design	Concrete planning and implementation of the plant structure / of the wiring. Concrete implementation of the safety functions by programming in FUP	Nil

Table 9: Phases of the V model

19.3.1. Specification of the safety requirements

On the basis of the standards to be observed, e. g. product standards, the safety requirements must be analyzed in detail.

- 1 General product and project information**
 - 1.1 Product identification
 - 1.2 Author, version, date, document name, file name
 - 1.3 Contents
 - 1.4 Terminology, definitions, glossary
 - 1.5 Version history and changes
 - 1.6 Directives, standards and technical rules relevant to development
- 2 Functional information on the machine, where relevant to safety**
 - 2.1 Intended use and reasonably foreseeable misuse
 - 2.2 Process description (operating functions)
 - 2.3 Operating modes (e.g. setup mode, automatic mode, operation of localized relevance or of parts of the machine)
 - 2.4 Characteristic data, e.g. cycle times, response times, overrun distances
 - 2.5 Other characteristics of the machine
 - 2.6 Safe state of the machine
 - 2.7 Interaction between processes (see also 2.2) and manual actions (repair, setup, cleaning, troubleshooting, etc.)
 - 2.8 Emergency operations
- 3 Required Performance Level(s) (PL_r)**
 - 3.1 Reference to existing documentation concerning the hazard analysis and risk assessment for the machine
 - 3.2 Results of the risk assessment for each identified hazard or hazardous situation and specification of the safety function(s) required in each case for risk reduction

4 Safety functions (information applies to each safety function)

- Description of the function ("input – logic – output") including all functional characteristics (refer also to Tables 5.1 and 5.2)
- Activation/deactivation conditions or events (e.g. operating modes of the machine)
- Behaviour of the machine when the safety function is triggered
- Conditions to be observed for re-starting
- Performance criteria/performance data
- Process (timing behaviour) of the safety function, including response time
- Frequency of actuation (i.e. demand rate), recovery time following demand
- Other data
- Adjustable parameters (where provided)
- Classification and assignment of priorities in the event of simultaneous demand for and processing of multiple safety functions
- Functional concept for separation or independence/freedom of reciprocal action from non-safety functions and further safety functions

5 Required information for the SRP/CS design

- 5.1 Allocation of the SRP/CS and the form of technology by which the safety function is to be implemented; intended equipment
- 5.2 Selection of the Category, designated architecture (structure) in the form of a safety-related block diagram and description
- 5.3 Description of the interfaces (process interfaces, internal interfaces, user interfaces, control and display elements, etc.)
- 5.4 Behaviour at switch-on, implementation of the required starting and restarting behaviour
- 5.5 Performance data: cycle times, response times, etc.
- 5.6 Behaviour of the SRP/CS in the event of component failures and faults (achieve and maintain the safe state), including timing behaviour
- 5.7 Failure modes of components, modules or blocks which are to be considered; where applicable, reasoning for fault exclusions
- 5.8 Concept for implementation of the detection and control of random and systematic failures (self-tests, test circuits, monitoring arrangements, comparisons, plausibility tests, fault detection by the process, etc.)
- 5.9 Quantitative aspects
 - 5.9.1 Target values for $MTTF_d$ and DC_{avg}

- 5.9.2 Switching frequency of components subject to wear
- 5.9.3 Frequency of measures for fault detection
- 5.9.4 Mission time, where different from the assumption upon which the intended architecture is based (20 years)
- 5.10 Operating and limit data (operating and storage temperature range, humidity class, IP degree of protection, resistance values for shock/vibration/EMC, supply data with tolerances, etc.)
- 5.11 Generic standards to be applied for design (for the equipment, for protection against electric shock/hazardous shock currents, for resistance to environmental conditions, etc.)
- 5.12 Technical and organizational measures for protected access to safety-related parameters and to SRP/CS characteristics (protection against tampering, access protection, program/data protection) and for protection against unauthorized operation (key switch, code, etc.), for example in non-standard operating modes
- 5.13 General technical requirements and organizational framework for commissioning, testing and acceptance, and for maintenance and repair

Fig. 65: safety requirements

Source: General guideline, excerpt from BGIA Report 2/2008 zu EN ISO 13849-1

19.3.2. Specification of the safety system

Based on the general hazard and risk analysis of the machine, the active protective functions must be identified and specified.

Active protective functions are, for example, safely reduced speed in certain system states, monitored stop and standstill functions, area monitoring, processing of monitoring devices such as light grids, switching mats, etc.

The safety functions must be differentiated in each case and the specific requirements defined in terms of function and safety level.

19.3.2.1. Definition of the safety functions

The definition of the safety functions must contain:

- Identification of the risk to be covered
- Description of the exact function
- Listing of all involved sensors, command devices
- Naming of all control units
- Naming of the triggered shut-off circuit

The definition is intended to serve as the basis for the hardware and software design specification.

The parameters that may be used, such as max. system speed in setup mode, etc., must be determined for each of the safety functions defined in this way.

Examples of safety functions:

- SF1: STO (Safe Turn-Off) to protect the plant from a safe start
- SF2: safe speeds
- SF3: safe positions
- SF4: ...

Required Performance Level (PL r) (additional emergency stop)

Now, the required Performance Level PL r must be determined from the safety functions SF1... that have been recognized above.

Required Performance Level: d



Severity of injury (S)

S1 Slight (normally reversible injury)

✓ S2 Serious (normally irreversible injury or death)

Frequency and/or exposure times to hazard (F)

✓ F1 Seldom to less often and/or exposure time is short

F2 Frequent to continuous and/or exposure time is long

Possibility of avoiding hazard or limiting harm (P)

P1 Possible under specific conditions

✓ P2 Scarcely possible

Fig. 66: decision path acc. to SISTEMA

Example for SF1: result of PL r = d (source SISTEMA)

19.3.3. Software specification

The software specification refers to the preceding specification of the safety functions. The software specification can also be replaced by an accordingly elaborated specification of the safety functions if this specification of the safety function contains all requirements (cf. the example under 19.3.2.1)

It is recommended to create an extracted list.

This extracted list should contain the following information:

- Designation of the safety function
- Description of the safety function
- Parameters if available
- Triggering event / operating state
- Reaction / output

The specification should be detailed enough to be suitable for a later validation of the programming.

19.3.4. Hardware specification

In the hardware specification describes the complete plant structure, and especially the components used within the plant structure together with their specific identification data. The hardware specification serves as basis for the determination of the achieved safety level. The achieved safety level is determined on the basis of the architecture and of the identification data of all devices that participate in a safety function.

Furthermore, in the hardware specification also the constructive protective measures against systematic errors and Common Cause errors must be indicated.

19.3.4.1. Selection of the SRP/CS and selection of the equipment

For every safety function, the SRP/CS (Safety related parts of control system) must be selected in a way that is suitable to achieve the desired safety level for every safety function. In an overall survey of the plant structure, the components with safety-related functions must be indicated, and they must be assigned to the particular safety functions. The safety indices of the components with safety-related functions must be determined.

The safety indices include the following values:

MTTFd = mean time to failure (dangerous) = the mean time until the dangerous failure occurs)

DC avg = average diagnostic coverage range

CCF = common cause failure, failure due to a common cause

For an SRP/CS also the software and the systematic errors must be considered.

Basically, an analysis of the SRP/CS that a part of a safety function must be carried out according to the scheme sensor / PES / actuator.

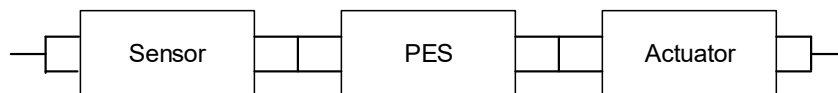

19.3.4.2. Consideration of systematic failures

Within the hardware specification also systematic failures must be considered.

Example of measures against systematic failures:

Loss of energy during operation: If the loss of energy is dangerous, the loss of energy must be considered like an operating state.

The SRP/CD must control this state, so that the safe state is maintained.

Measures of systematic failures according to DIN EN ISO 13849-9, appendix G.

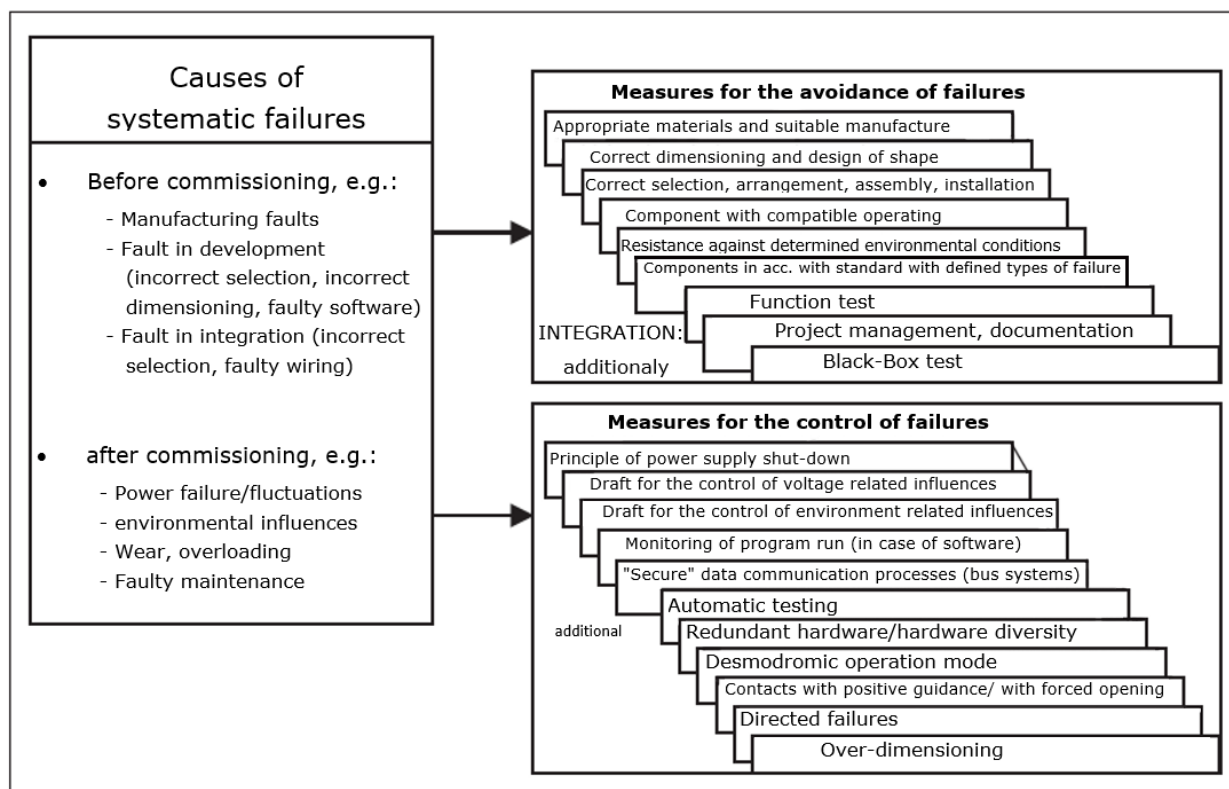

Fig. 67: Systematic failures

Source: BGIA Report 2/2008

19.3.4.3. Fault exclusions

If fault exclusions are made for certain devices or for certain plant components, these fault exclusions must be named and specified in detail.

Fault exclusions can be e. g. mechanical shaft break, bonding of switch contacts, short circuits on cables, wires etc.

The legitimacy of the error exclusions should be substantiated, e. g. by references to the legitimate fault exclusions according to relevant standards, e. g. EN ISO 13849-1.

If particular measures are necessary for these fault exclusions, the necessary measures must be indicated.

Examples of fault exclusions and assigned measures:

- Positive-locking connection in case of mechanical shaft connections
- Dimensioning on the basis of sufficient theoretical basics in case of fractures of components of the security chain
- Forced guidance in connection with forced separation of switch contacts
- Protected laying within the switching system in case of short circuits in cables and wires, and if cables are laid in cable ducts.

19.3.5. Hardware design and software design

The stipulations of the hardware design and the stipulations of the software design are implemented in the design of the proper plant.

The stipulations for the components to be used and for their circuitry that are indicated in the hardware specification must be observed just as the stipulations for the error exclusions. The compliance with each of the above stipulations must be ensured and documented by appropriate means.

In the software, also the stipulations of the software specification must be observed and must be completely implemented.

Furthermore, here the subordinate stipulations for the software concerning safety-relevant programming must be observed. Stipulations for safety-relevant programming are among others:

- Clear and modular structure of the program
- Assignment of the functions to the safety functions
- Understandable presentation of the functions by:
 - Unique designations
 - Understandable comments
 - Use of tested functions or tested function block to the greatest possible extent
- Defensive programming

19.3.5.1. Testing of the hardware design

After planning is completed, it must be checked if the hardware design complies with the stipulations indicated in the hardware specification.

Furthermore, for every safety function the compliance with the specified safety level must be checked by means of an appropriate analysis. The analysis procedures are described in the relevant standards (e. g. EN13849-1).

19.3.5.2. Analysis of the circuit diagram

The compliance with the safety-relevant stipulations must be checked by means of the switch diagram and by means of the piece list. In particular, the following items must be checked:

- The correct circuitry of the components according to the respective stipulations.
- The two-channel structure, if stipulated.
- The die Rückwirkungsfreiheit von parallelen, redundanten Kanälen.
- The use of the components according to the respective stipulations.

The audit is to be carried out by comprehensible analysis.

19.3.5.3. Iterative test of the achieved safety level

The achieved safety level must be determined by means of the circuit configuration (= one-channel architecture / two-channel architecture / with diagnostics or without diagnostics), by means of the device data (according to manufacturer information or according to relevant sources), and by means of the diagnostic coverage (information by the manufacturer of the PES or general sources). The relevant procedures must be taken from the safety standard used.

19.3.5.4. Verification of the software and parameters

The verification takes place in two steps:

- Verification of the functional scheme with respect to the specified functionality
- Verification of the functional scheme against the IL listing (IL = Instruction List) of the validation report, or rather, verification of the given parameters against the parameters listed in the validation report.

Verification of the functional scheme

For verification, the actually programmed function chart must be compared to the stipulations of the specifications.

The clearer programming has been structured with respect to the safety functions, the more efficient is the comparison.

Validation of the functional scheme against the Instruction List (AWL) and parameters via a validation report

The programming carried out in the FUP can be compared with the AWL listing of the validation report.

A step-by-step check is recommended. The check is more efficient if the programming in the FUP was executed in a structured manner.

After checking of the program, the parameters must be checked and compared against the requirements in the specification.

19.3.5.5. Execution of system tests / FIT (Fault Injection Test)

For the FIT, the manufacturer must compile a list of functions that must be tested. This list includes the defined safety functions as well as error tests to verify the correct reaction of the SRP/CS to these faults.

20. List of abbreviaions

Abbreviation	Meaning	Comment
AC	Alternating Current	
BBH	Manufacturer of assemblies	
CRC	Cyclic Redundancy Check	Cyclical checksum calculation
DC	Diagnostic Coverage	
BG	Berufsgenossenschaft	Employer's Liability Insurance Association
Cat.	Category according to EN 13849-1	Architecture category
CE	Communauté Européenne	Symbol of conformity with relevant EU directives
CLK	Clock	cycle
CPU	Central Processing Unit	
DC	Direct Current	
DIN	Deutsches Institut für Normung	German Standardization Institute
[EMU]	Emergency Monitoring Unit	Safety function
[ELC]	Emergency Limit Control	Safety function
EMC	Electromagnetic compatibility	
EN	European Norm	
EtherCAT	EtherCAT (name)	Data protocol
FSoE	Fail Safe over EtherCAT	Safe data transfer via EtherCAT protocol
FUP	Function plan	
GND	Ground	Ground potential 0 VDC
H / HISIDE	High Side	Positive switching output 24 VDC
HW	Hardware	
I.	Input.	
IL	Instruction List	List of the commands within the assembly
IO	Input Output	Digital input / digital output
IP	International Protection	Protection class according to the norm
ISO	International Organization for Standardization	
LED	Light Emitting Diode	Electroluminescent diode
LOSIDE	Low Side	Output switching after grounding 0 VDC
O.	Output.	
PAA	Prozessabbild der Ausgänge	Process image of the outputs
PAE	Prozessabbild der Eingänge	Process image of the inputs
PELV	Protective Extra Low Voltage	

Abbreviation	Meaning	Comment
PLC	Programmable Logic Controller	
POR	Power On Reset	RESETprocedure
SafePLC2	Program for the programming of PLC	Programming surface for the programming of assemblie developed by BBH
SCU	Safe Control Unit	FSoE Master assembly to process encoder data, input data and output data
SDDC	Safe Device to Device Communication	
SDU	Safe Drive Unit	FSoE assembly to record encoder values
SDP	Safe Drive Profile	Data profile for safe encoder data
SELV	Safe Extra Low Voltage	Safe (fused) low voltage
SIO	Safe IO	FSoE-Slave assembly to record digital inputs / digital outputs
SMMC	Safe Master to Master Communication	
SSB	Safe Sensor Box	FSoE-Slave assembly to record encoder data from 6 encoders
SSI	Synchronous Serial Interface	
SW	Software	
T.	Pulse output.	Pulsed signal
VDE	Verband der Elektrotechnik	Registered Association of the Electrical, Electronic and Information Technology Association

Table 10: Abbreviations

21. Appendix

21.1. Appendix A – EC declaration



EG-Konformitätserklärung für Sicherheitsbauteile im Sinne der EG-Maschinenrichtlinie 2006/42/EG (Anhang IV)

*EC declaration of conformity
for safety components according the EU Machinery
Directive 2006/42/EG (Appendix IV)*

Firma <i>Manufacturer</i>	BBH Products GmbH
Anschrift <i>Address</i>	Böttgerstrasse 40 92637 Weiden Deutschland
Produkt	SCU Serie Frei programmierbare Sicherheitssteuerung zur Überwachung von Antriebssystemen, geeignet für SIL 3 IEC 61508:2010, bzw. PL e nach EN ISO 13849-1:2015.
<i>Product</i>	<i>SCU Serie Free programmable safe plc for monitoring of drives, appropriated for SIL 3 IEC 61508:2010, resp. PL e according EN ISO 13849-1:2015</i>
Produktname	Produktliste siehe Anhang
<i>Product name</i>	<i>product list see annex</i>

Das Produkt wurde entwickelt, konstruiert und gefertigt in Übereinstimmung der o.g. Richtlinie.
*The product was developed, designed and manufactured in accordance to the directive as
named above*

Folgende Normen wurden angewendet:
Following standards were applied:

Norm / Standard	Titel / Title	Ausgabe / Edition
EN ISO 13849-1	Sicherheit von Maschinen - Sicherheitsbezogene Teile von Steuerungen - Teil 1: Allgemeine Gestaltungsleitsätze <i>Safety of machinery - Safety-related parts of control systems - Part 1: General principles for design</i>	2015
EN 62061	Sicherheit von Maschinen - Funktionale Sicherheit sicherheitsbezogener elektrischer, elektronischer und programmierbarer elektronischer Steuerungssysteme <i>Safety of machinery - Functional safety of safety-related electrical, electronic, programmable electronic control systems</i>	2005 + AC:2010 + A1:2013 + A2:2015

Norm / Standard	Titel / Title	Ausgabe / Edition
IEC 61508	Teil 1-7: Funktionale Sicherheit sicherheitsbezogener elektrischer/elektronischer/programmierbarer elektronischer Systeme <i>Part 1-7: Functional safety of electrical/electronic/programmable electronic safety-related systems</i>	2010
EN 61800-3	Drehzahlveränderbare elektrische Antriebe - Teil 3: EMV-Anforderungen einschließlich spezieller Prüfverfahren <i>Adjustable speed electrical power drive systems - Part 3: EMC requirements and specific test methods.</i>	2018
EN 61800-5-1	Elektrische Leistungsantriebssysteme mit einstellbarer Drehzahl - Teil 5-1: Anforderungen an die Sicherheit – Elektrische, thermische und energetische Anforderungen <i>Adjustable speed electrical power drive systems - Part 5-1: Safety Requirements- Electrical, thermal and energy</i>	2007 + A1:2017
IEC 61800-5-2	Elektrische Leistungsantriebssysteme mit einstellbarer Drehzahl Teil 5-2: Anforderungen an die Sicherheit – Funktionale Sicherheit <i>Adjustable speed electrical power drive systems - Part 5-2: Safety requirements - Functional</i>	2017
EN IEC 63000	Technische Dokumentation zur Beurteilung von Elektro- und Elektronikgeräten hinsichtlich der Beschränkung gefährlicher Stoffe <i>Technical documentation for the assessment of electrical and electronic products with respect to the restriction of hazardous substances</i>	2018
EN 61000-1-2	Elektromagnetische Verträglichkeit (EMV) - Teil 1-2: Allgemeines - Verfahren zum Erreichen der funktionalen Sicherheit von elektrischen und elektronischen Systemen einschließlich Geräten und Einrichtungen im Hinblick auf elektromagnetische Phänomene. <i>Electromagnetic compatibility (EMC) - Part 1-2: General - Methodology for the achievement of functional safety of electrical and electronic systems including equipment with regard to electromagnetic phenomena.</i>	2016
EN 61000-6-7	Elektromagnetische Verträglichkeit (EMV) - Teil 6-7: Fachgrundnormen - Störfestigkeitsanforderungen an Geräte und Einrichtungen, die zur Durchführung von Funktionen in sicherheitsbezogenen Systemen (funktionale Sicherheit) an industriellen Standorten vorgesehen sind. <i>Electromagnetic compatibility (EMC) - Part 6-7: Generic standards - Immunity requirements for equipment intended to perform functions in a safety-related system (functional safety) in industrial locations</i>	2015
EN 61131-2	Speicherprogrammierbare Steuerungen - Teil 2: Betriebsmittelanforderungen und Prüfungen <i>Industrial-process control systems - Instruments with analogue inputs and two- or multi-state outputs - Part 2: Guidance for inspection and routine testing</i>	2008
EN 50178	Ausrüstung von Starkstromanlagen mit elektronischen Betriebsmitteln <i>Electronic equipment for use in power installations</i>	1997

Bemerkungen / Notes:

Die Produkte entsprechen den Anforderungen der Niederspannungs-Richtlinie 2014/35/EU und der EMV-Richtlinie 2014/30/EU.

The products are in accordance to the Low Voltage Directive 2014/35/EC and EMC Directive 2014/30/EC.

Den im Produkthandbuch beschriebenen Sicherheits-, Installations- und Bedienungshinweisen muss Folge geleistet werden.

These products must be installed and operated with reference to the instructions in the Product Manual.

All instructions, warnings and safety information of the Product Manual must be adhered to.

Für das Produkthandbuch zeichnet sich Dipl.-Ing. (FH) Gerhard Bauer verantwortlich.

For the Product Manual is responsible Dipl.-Ing. (FH) Gerhard Bauer.

Weiden, 21/07/2023

Gerhard Bauer, *Managing Director*

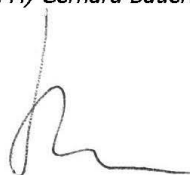

Anhang

annex

Typ Type	Beschreibung Description	Version / Version	
		Hardware	Firmware CPU / FPGA
SCU-1-EC	Sicherheitssteuerung zur Überwachung von Antriebssystemen <i>Safety controller for monitoring drive systems</i>	13-04	03-01-00-01 / 101 03-01-00-03 / 101 03-01-01-07 / 117 03-01-01-09 / 117
SCU-2-EC	Sicherheitssteuerung zur Überwachung von Antriebssystemen <i>Safety controller for monitoring drive systems</i>	13-04-10-10	03-01-00-01 / 101 03-01-00-03 / 101 03-01-01-07 / 117 03-01-01-09 / 117
SCU-1-EC/NM	Sicherheitssteuerung zur Überwachung von Antriebssystemen <i>Safety controller for monitoring drive systems</i>	13-04-07	03-01-00-01 / 101 03-01-00-03 / 101 03-01-01-07 / 117 03-01-01-09 / 117
SCU-2-EC/NM	Sicherheitssteuerung zur Überwachung von Antriebssystemen <i>Safety controller for monitoring drive systems</i>	13-04-10-10-07	03-01-00-01 / 101 03-01-00-03 / 101 03-01-01-07 / 117 03-01-01-09 / 117
SIO-1	Dezentrale I/O Erweiterung <i>Decentralized I/O expansion</i>	13-04	03-01-00-01 / 101 03-01-00-03 / 101
SIO-2	Dezentrale I/O Erweiterung <i>Decentralized I/O expansion</i>	13-04-10-10	03-01-00-01 / 101 03-01-00-03 / 101



**EG-Konformitätserklärung für Sicherheitsbauteile
im Sinne der EG-Maschinenrichtlinie 2006/42/EG (Anhang IV)**

*EC declaration of conformity
for safety components according the EU Machinery
Directive 2006/42/EG (Appendix IV)*

Firma <i>Manufacturer</i>	BBH Products GmbH
Anschrift <i>Address</i>	Böttgerstrasse 40 92637 Weiden Deutschland
Produkt	SDU Serie Frei programmierbare Sicherheitssteuerung zur Überwachung von Antriebssystemen, geeignet für SIL 3 IEC 61508:2010, bzw. PL e nach EN ISO 13849-1:2015.
<i>Product</i>	<i>SDU Serie Free programmable safe plc for monitoring of drives, appropriated for SIL 3 IEC 61508:2010, resp. PL e according EN ISO 13849-1:2015</i>
Produktname	Produktliste siehe Anhang
<i>Product name</i>	<i>product list see annex</i>

Das Produkt wurde entwickelt, konstruiert und gefertigt in Übereinstimmung der o.g. Richtlinie.
*The product was developed, designed and manufactured in accordance to the directive as
named above*

Folgende Normen wurden angewendet:
Following standards were applied:

Norm / Standard	Titel / Title	Ausgabe / Edition
EN ISO 13849-1	Sicherheit von Maschinen - Sicherheitsbezogene Teile von Steuerungen - Teil 1: Allgemeine Gestaltungsleitsätze <i>Safety of machinery - Safety-related parts of control systems - Part 1: General principles for design</i>	2015
EN 62061	Sicherheit von Maschinen - Funktionale Sicherheit sicherheitsbezogener elektrischer, elektronischer und programmierbarer elektronischer Steuerungssysteme <i>Safety of machinery - Functional safety of safety-related electrical, electronic, programmable electronic control systems</i>	2005 + AC:2010 + A1:2013
EN 50178	Ausrüstung von Starkstromanlagen mit elektronischen Betriebsmitteln <i>Equipment of power installations with electronic equipment</i>	1997

Norm / Standard	Titel / Title	Ausgabe / Edition
EN 60204-1	Sicherheit von Maschinen – Elektrische Ausrüstung von Maschinen – Teil 1: Allgemeine Anforderungen <i>Safety of machinery – Electrical equipment of machines – Part 1: General requirements</i>	2006 + A1:2009 + AC:2010 (auszugsweise / in extracts)
EN ISO 13850	Sicherheit von Maschinen, Not-Halt, Gestaltungsleitsätze <i>Safety of machinery, Emergency stop, principles for design</i>	2008
IEC 61508	Teil 1-7: Funktionale Sicherheit sicherheitsbezogener elektrischer/elektronischer/programmierbarer elektronischer Systeme <i>Part 1-7: Functional safety of electrical/electronic/programmable electronic safety-related systems</i>	2010
EN 55011 (Klasse A)	Industrielle, Wissenschaftliche und medizinische Geräte – Funkstörungen – Grenzwerte und Messverfahren <i>Industrial, scientific and medical equipment – Radio-frequency disturbance characteristics – Limits and methods of measurements</i>	2009 + A1:2010
EN 61800-3	Drehzahlveränderbare elektrische Antriebe – Teil 3: EMV-Anforderungen einschließlich spezieller Prüfverfahren <i>Adjustable speed electrical power drive systems – Part 3: EMC requirements and specific test methods.</i>	2004 + A1:2012
EN 61800-5-2	Elektrische Leistungsantriebssysteme mit einstellbarer Drehzahl Teil 5-2: Anforderungen an die Sicherheit – Funktionale Sicherheit <i>Adjustable speed electrical power drive systems – Part 5-2: Safety requirements – Functional</i>	2007
EN 61000-6-2	Elektromagnetische Verträglichkeit (EMV) – Teil 6-2: Fachgrundnormen – Störfestigkeit für Industriebereiche <i>Electromagnetic compatibility (EMC) – Part 6-2: Generic standards – Immunity for industrial environments</i>	2005
EN 61000-6-4	Elektromagnetische Verträglichkeit (EMV) – Teil 6-4: Fachgrundnormen – Störaussendung für Industriebereiche <i>Electromagnetic compatibility (EMC) – Part 6-4: Generic standards – Emission standards for industrial environments</i>	2007 + A1:2011

Bemerkungen / Notes:

Die Produkte entsprechen den Anforderungen der Niederspannungs-Richtlinie 2014/35/EU und der EMV-Richtlinie 2014/30/EU.

The products are in accordance to the Low Voltage Directive 2014/35/EC and EMC Directive 2014/30/EC.

Den im Produkthandbuch beschriebenen Sicherheits-, Installations- und Bedienungshinweisen muss Folge geleistet werden.

These products must be installed and operated with reference to the instructions in the Product Manual.

All instructions, warnings and safety information of the Product Manual must be adhered to.

Für das Produkthandbuch zeichnet sich Dipl.-Ing. (FH) Gerhard Bauer verantwortlich.

For the Product Manual is responsible Dipl.-Ing. (FH) Gerhard Bauer.

Weiden, 21/07/2023

Gerhard Bauer, *Managing Director*



Anhang

annex

Typ Type	Beschreibung Description	Version / Version	
		Hardware	Firmware CPU
SDU-11/x	Kompaktsteuerung mit Safe Motion (inkl. PROFIsafe-Stack oder FSoE-Stack) 1 Achse Optional mit Universal Kommunikationsinterface <i>Compact controller with Safe Motion (incl. PROFIsafe stack or FSoE stack) 1 axis Optionally with universal communication interface</i>	11-11-07	05-00-00-01 PS 05-00-00-17 PS 05-00-04-19 PS 05-01-00-01 FSoE
SDU-11-PXV/x	Kompaktsteuerung mit Safe Motion (inkl. PROFIsafe-Stack oder FSoE-Stack) 1 PXV Achse Optional mit Universal Kommunikationsinterface <i>Compact controller with Safe Motion (incl. PROFIsafe stack or FSoE stack) 1 PXV axis Optionally with universal communication interface</i>	11-11-07	05-00-02-33 PS 05-00-05-43 PS 05-01-02-33 FSoE
SDU-12/x	Kompaktsteuerung mit Safe Motion (inkl. PROFIsafe-Stack oder FSoE-Stack) 1 Achse Optional mit Universal Kommunikationsinterface <i>Compact controller with Safe Motion (incl. PROFIsafe stack or FSoE stack) 1 axis Optionally with universal communication interface</i>	11-11-07	05-00-00-01 PS 05-00-00-17 PS 05-00-04-19 PS 05-01-00-01 FSoE
SDU-21/x	Kompaktsteuerung mit Safe Motion (inkl. PROFIsafe-Stack oder FSoE-Stack) 2 Achse Optional mit Universal Kommunikationsinterface <i>Compact controller with Safe Motion (incl. PROFIsafe stack or FSoE stack) 2 axis Optionally with universal communication interface</i>	11-11-04-07	05-00-00-01 PS 05-00-00-17 PS 05-00-04-19 PS 05-01-00-01 FSoE
SDU-21-PXV/x	Kompaktsteuerung mit Safe Motion (inkl. PROFIsafe-Stack oder FSoE-Stack) 2 Achsen davon eine PXV Achse Optional mit Universal Kommunikationsinterface <i>Compact controller with Safe Motion (incl. PROFIsafe stack or FSoE stack) 2 axes, one of which is a PXV axle Optionally with universal communication interface</i>	11-11-04-07	05-00-02-33 PS 05-00-05-43 PS 05-01-02-33 FSoE
SDU-21A/x	Kompaktsteuerung mit Safe Motion und Analog (inkl. PROFIsafe-Stack oder FSoE-Stack) 2 Achsen	11-11-04-07	05-00-00-01 PS 05-00-00-17 PS 05-00-04-19 PS 05-01-00-01 FSoE

	Optional mit Universal Kommunikationsinterface <i>Compact controller with Safe Motion and analogue (incl. PROFIsafe stack or FSoE stack)</i> <i>2 axis Optionally with universal communication interface</i>		
SDU-22/x	Kompaktsteuerung mit Safe Motion (inkl. PROFIsafe-Stack oder FSoE-Stack) 2 Achsen Optional mit Universal Kommunikationsinterface <i>Compact controller with Safe Motion (incl. PROFIsafe stack or FSoE stack)</i> <i>2 axes Optionally with universal communication interface</i>	11-11-04-04-07	05-00-00-01 PS 05-00-00-17 PS 05-00-04-19 PS 05-01-00-01 FSoE
SDU-22A/x	Kompaktsteuerung mit Safe Motion und Analog (inkl. PROFIsafe-Stack oder FSoE-Stack) 2 Achsen Optional mit Universal Kommunikationsinterface <i>Compact controller with Safe Motion and analogue (incl. PROFIsafe stack or FSoE stack)</i> <i>2 axes Optionally with universal communication interface</i>	11-11-04-04-07	05-00-00-01 PS 05-00-00-17 PS 05-00-04-19 PS 05-01-00-01 FSoE

SCU-0-EC/x

SCU SERIES » SCU Master

BBH
PRODUCTS



DESCRIPTION

Open programmable and configurable FSoE master unit for operation on EtherCAT networks

- Simple integration of safe drives (Safe Drive Profile)
- Fast-Channel task for logic processing with a guaranteed response time of 4 ms
- Safety controller up to PL e acc. to EN ISO 13849-1 or SIL3 acc. to IEC 61508
- optional: kinematics module, PROFIsafe / FSoE-Slave stack

CHARACTERISTIC OF THE MODULE

- » Connection of up to 32 FSoE Slave units
- » Safe logic processing of input, output, status and activation signals
- » Simple and transparent programming and parametrization in the EtherCAT environment via SafePLC²
- » Fast response time with integrated Fast Channel Task with guaranteed processing time of 4 ms
- » Central or decentralized drive monitoring possible
- » Complete set of Drive monitoring for single axes and charged axes (based on Kinematics function)
- » Temporary deterministic data communication and processing for safe position und speed functions via distributed sensor / multiple axes
- » Specific profiles for process data exchange and central parametrization that can be adapted to converter/manufacture
- » Safe cross communication (**S**afe **M**aster- **M**aster **C**ommunication) for data exchange between FSoE masters via EAP
- » Storage of safe parameters in the basic module
- » Coded status display via front-side 7 segment display and status LEDs
- » Multifunction buttons (quit, start, reset) can be operated from the front side
- » Optional integrated Communication interface :
 - additional field bus interface and PROFIsafe / FSoE-Slave stack for secure connectivity to higher levels of control
 - safe kinematics module for up to 6/12 axes with spatial speed and position monitoring
- » The mechanical structure of SCU-0-EC (/x*) is depended on the respective forms of the base module

* Optional: integrated Communication interface (/NM)

Appendix: data sheets SCU Master

SCU-0-EC/x

SCU_{SERIES} » SCU Master



SAFETY RELATED CHARACTERISTIC DATA

Performance Level	PL e (EN ISO 13849-1)
PFH / architecture	PFH = $7,68 \cdot 10^{-9}$
	MTTFd = 280 years = high
	DCavg = high
Safety Integrity Level	SIL 3 (IEC 61508)
Proof test interval	20 years = max. operating period

GENERAL DATA

Max. no. of expansion modules	32
Interface for expansion modules	RJ-45 (Ethernet)
Number of safe digital inputs	–
Number of safe digital outputs	–
Number of safe digital I/O	–
Number of relay outputs	–
Number of safe analogue inputs	–
Number of auxiliary outputs	–
Number of pulse outputs (clock outputs)	–
Type of connection	Plug-in terminals with spring or screw connection
Cycle time PLC	16 ms
Fast Channel central / SCU	4 ms
Fast Channel decentralized SSB / standard Slave	4 ms
Safe Master	FSoE
Safe Slave *	PROFIsafe / FSoE / CIP Safety
Non-safe Slave	EtherCAT

* optional: integrated communication interface (/NM)

ELECTRICAL DATA

Supply voltage (tolerance)		24 VDC (-10%, +15%)
Fuse	24+	min. 30 VDC; max. 3,15A
Max. Power consumption (logic)	SCU-0-EC	3,1 W
Rated data digital inputs		24 VDC; 20 mA Typ1 acc. to IEC 61131-2
Rated data digital outputs		–
Rated data relays		–

Appendix: data sheets SCU Master

SCU-0-EC/x

SCU_{SERIES} » SCU Master



ENVIRONMENTAL DATA

Temperature	0°C ... +50°C operation
	-25°C ... +70°C storage and transport
Class of protection	IP 20
Climatic category	3K3 acc. to DIN EN 60721-3
Min-, Maximum relative humidity (no condensation)	5% - 85%
EMC	DIN EN 61000-6-2, DIN EN 61000-6-4, DIN EN 61000-6-7, DIN EN 61800-3, DIN EN 61326-3, DIN EN 62061
Operating altitude	2000m

MECHANICAL DATA

Dimensions (HxDxW [mm])	SCU-0-EC	100x115x45
	SCU-0-EC/x *	100x115x67,5
Weight [g]	SCU-0-EC	162
	SCU-0-EC/x *	248
Mounting	to snap on top-hat rail	
Min. terminal cross-section / AWG	0,2 mm ² / 24	
Max. terminal cross-section / AWG	2,5 mm ² / 12	

* Specification, see: „Optional integrated communication interface“

Appendix: data sheets SCU Master

SCU-0-EC/x SCUSERIES » SCU Master



DEVICE INTERFACES

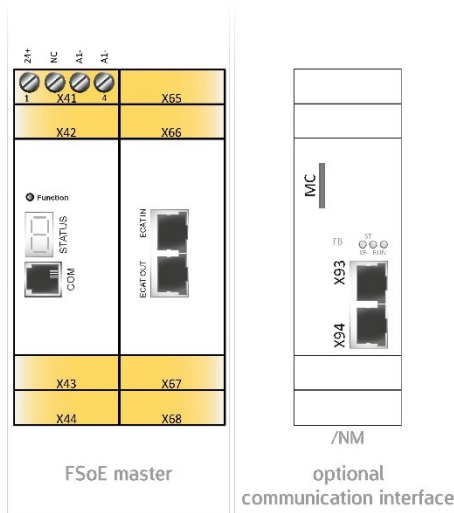

Interface	Description of interface
X41 – X44 / X65 – X68	Diagnostic and configuration interface
COM	Fieldbus interfaces *
ECAT IN / OUT	Fieldbus interfaces *
X93 / X94	Feldbus-Schnittstellen*

* configurable via SafePLC²

VOLTAGE SUPPLY AND I/O INTERFACE

X41		
Pin	1 - 24+	Voltage supply device +24 VDC
	2 - NC	No function
	3 - A1- 4 - A1-	Voltage supply device 0 VDC
X42		
Pin	1 - NC	No function
	2 - NC	
	3 - NC	
	4 - NC	
X43		
Pin	1 - NC	No function
	2 - NC	
	3 - NC	
	4 - NC	
X44		
Pin	1 - NC	No function
	2 - NC	
	3 - NC	
	4 - NC	

X65		
Pin	1 - NC	No function
	2 - NC	
	3 - NC	
	4 - NC	
X66		
Pin	1 - NC	No function
	2 - NC	
	3 - NC	
	4 - NC	
X67		
Pin	1 - NC	No function
	2 - NC	
	3 - NC	
	4 - NC	
X68		
Pin	1 - NC	No function
	2 - NC	
	3 - NC	
	4 - NC	

Appendix: data sheets SCU Master

SCU-0-EC/x

SCU_{SERIES} » SCU Master



DIAGNOSTIC AND CONFIGURATION INTERFACE

Pin assignment

RJ 10, 4-pin		
Pin	Beschreibung	COM front side
1	GND	
2	RS485-	
3	RS485+	
4	VCCH	

» With existing Ethernet-based fieldbus interface, it can be used as a diagnostic and configuration interface.

FIELDBUS INTERFACES

Pin assignment female connector

EtherCAT interface / optional Ethernet-based fieldbus interface (RJ45)				
Pin	Name	Description	Colour	EtherCAT IN/OUT , X93 / X94
1	TX+	Transmit Data +	white-orange	
2	TX-	Transmit Data -	orange	
3	RX+	Receive Data +	white-green	
4	nc	Not used	blue	
5	nc	Not used	white-blue	
6	RX-	Receive Data -	green	
7	nc	Not used	white-brown	
8	nc	Not used	brown	

OPTIONAL INTEGRATED COMMUNICATION INTERFACE

» The optionally integrated communication interface expands the FSoE-Master with a additional safe fieldbus interface (/NM)

General data		
Fieldbus interface	/N	2x RJ 45 *
Memory Card (safety program)	/xM	1x Mini SD (front side)
Status LED's		4

* available field buses: FSoE, PROFIsafe

Appendix: data sheets SCU Master

SCU-0-EC/x

SCU_{SERIES} » SCU Master



ORDER INFORMATIONS

FSoE MASTER

item	description	item no.
SCU-0-EC	FSoE Master - modular basic module	2411
SCU-0-EC/NM	FSoE Master + ethernet-based fieldbus interface + memory card	2412

ACCESSORIES

item	description	item no.
FSoE License	Field bus license for FSoE	2366
PROFIsafe License	Field bus license for PROFIsafe	2319
SMX91	Programming adapter	1010
SXxxx-x	Terminal connector, screw terminals (set), encoded for cabling SCU-0-EC (/NM)	on request
SXxxx-x	Terminal connector, spring terminals (set), encoded for cabling SCU-0-EC (/NM)	on request

FSoE SLAVES

item	description	item no.
SSB-3-AD-x	Axis expansion module for up to 3 axes + analog / digital	on request
SSB-6-EnDAT-x	Axis expansion module for up to 6 axes + EnDAT 2.2	1656
SSB-6-DSL-x	Axis expansion module for up to 6 axes + HyperfaceDSL	1665
SIO-1	Decentralized IO expansion module	2234
SIO-2	Decentralized IO expansion module	2235
SDU-11	Decentralized axis expansion module for one axis	2394
SDU-11/NM	Decentralized axis expansion module for one axis, safe PROFIsafe / FSoE-slave	2471
SDU-11-PXV	Decentralized axis expansion module for one axis, with safePXV encoder interface	2472
SDU-12	Decentralized axis expansion module for one axis	2395
SDU-21	Decentralized axis expansion module for 2 axes	2396
SDU-22	Decentralized axis expansion module for 2 axes	2397
SDU-21A	Decentralized axis expansion module for 2 axes + Analog Option	2398
SDU-21A-I	Decentralized axis expansion module for 2 axes + Analog Option (current.)	2399
SDU-21A-U	Decentralized axis expansion module for 2 axes + Analog Option (voltage)	2400
SDU-22A	Decentralized axis expansion module for 2 axes + Analog Option	2401
SDU-22A-I	Decentralized axis expansion module for 2 axes + Analog Option (current)	2402
SDU-22A-U	Decentralized axis expansion module for 2 axes + Analog Option (voltage)	2403

SOFTWARE

item	description	item no.
SafePLC ² 1st	Programming software, 1te License incl. Hardlock	1244
SafePLC ² 2nd	Programming software, 2te License incl. Hardlock	1646
SafePLC ² 3rd	Programming software, 3te License incl. Hardlock	1647

SCU-1-EC/x

SCU_{SERIES} » SCU master



DESCRIPTION

Open programmable and configurable FSoE master unit for operation on EtherCAT networks

- 14 safe digital Inputs
- up to 5 safe cut-off channels
- 2 Relay outputs
- Fast-Channel task for logic processing with a guaranteed response time of 4 ms
- Simple integration of safe drives (Safe Drive Profile)
- Safety controller up to PL e acc. to EN ISO 13849-1 or SIL3 acc. to IEC 61508
- optional: kinematics module, PROFIsafe / FSoE-Slave stack

CHARACTERISTIC OF THE MODULE

- » Connection of up to 32 FSoE Slave units
- » Safe logic processing of input, output, status and activation signals
- » Simple and transparent programming and parametrization in the EtherCAT environment via SafePLC²
- » Fast response time with integrated Fast Channel Task with guaranteed processing time of 4 ms
- » Central or decentralized drive monitoring possible
- » Complete set of Drive monitoring for single axes and charged axes (based on Kinematics function)
- » Temporary deterministic data communication and processing for safe position und speed functions via distributed sensor / multiple axes
- » Specific profiles for process data exchange and central parametrization that can be adapted to converter/manufacture
- » Safe cross communication (**Safe Master- Master Communication**) for data exchange between FSoE masters via EAP
- » Storage of safe parameters in the basic module
- » Coded status display via front-side 7 segment display and status LEDs
- » Multifunction buttons (quit, start, reset) can be operated from the front side
- » Optional integrated Communication interface :
 - additional field bus interface and PROFIsafe / FSoE-Slave stack for secure connectivity to higher levels of control
 - safe kinematics module for up to 6/12 axes with spatial speed and position monitoring
- » The mechanical structure of SCU-1-EC (x*) is depended on the respective forms of the base module

* Optional: integrated Communication interface (/NM)

Appendix: data sheets SCU Master

SCU-1-EC/x
SCUSERIES » SCU master

BBH
PRODUCTS

SAFETY RELATED CHARACTERISTIC DATA

Performance Level	PL e (EN ISO 13849-1)
PFH / architecture	PFH = $7,68 \cdot 10^{-9}$
	MTTFd = 280 years = high
	DCavg = high
Safety Integrity Level	SIL 3 (IEC 61508)
Proof test interval	20 years = max. operating period

GENERAL DATA

Max. no. of expansion modules	32
Interface for expansion modules	RJ-45 (Ethernet)
Number of safe digital inputs	14
Number of safe digital outputs	
	pp-switching * 4
	pn-switching * 2
Number of safe digital I/O	–
Number of relay outputs	2
Number of safe analogue inputs	–
Number of auxiliary outputs	–
Number of pulse outputs (clock outputs)	2
Type of connection	Plug-in terminals with spring or screw connection
Cycle time PLC	16 ms
Fast Channel central / SCU	4 ms
Fast Channel decentralized SSB / standard Slave	4 ms
Safe Master	FSoE
Safe Slave **	PROFIsafe / FSoE / CIP Safety
Non-safe Slave	EtherCAT

* pn / pp can be parameterized via SafePLC²

** **optional**: integrated communication interface (/NM)

Appendix: data sheets SCU Master

SCU-1-EC/x
SCU_{SERIES} » SCU master

BBH
PRODUCTS

ELECTRICAL DATA

Supply voltage (tolerance)		24 VDC (-10%, +15%)
Fuse	24+	min. 30 VDC; max. 3,15A
	AQ1+	min. 30 VDC; max. 10A
Max. Power consumption (logic)		
	SCU-1-EC/x	3,1 W
Rated data digital inputs		24 VDC; 20 mA Typ1 acc. to IEC 61131-2
Rated data digital outputs		
	pn-switching	24 VDC; 2A *
	pp-switching	24 VDC; 2A *
	pulse outputs (clock outputs)	24 VDC; 0,5 A
Rated data relays		
	Normally open	DC 13
		24 VDC; 2A
		AC 15
		230 VDC; 2A

DERATING OUTPUTS

- » Maximum current load based on temperature
- » The maximum total current is 10A

type of module	outputs	temperature 30°C / 50°C
SCU-1-EC/x	QX 00 – QX 03	2A / 1,8A

Appendix: data sheets SCU Master

SCU-1-EC/x
SCUSERIES » SCU master

BBH
PRODUCTS

ENVIRONMENTAL DATA

Temperature	0°C ... +50°C operation -25°C ... +70°C storage and transport
Class of protection	IP 20
Climatic category	3K3 acc. to DIN EN 60721-3
Min-, Maximum relative humidity (no condensation)	5% - 85%
EMC	DIN EN 61000-6-2, DIN EN 61000-6-4, DIN EN 61000-6-7, DIN EN 61800-3, DIN EN 61326-3, DIN EN 62061
Operating altitude	2000m

MECHANICAL DATA

Dimensions (HxDxW [mm])	SCU-1-EC	100x115x45
	SCU-1-EC/x *	100x115x67,5
Weight [g]	SCU-1-EC	312
	SCU-1-EC/x *	398
Mounting	to snap on top-hat rail	
Min. terminal cross-section / AWG	0,2 mm ² / 24	
Max. terminal cross-section / AWG	2,5 mm ² / 12	

* Specification, see: „Optional integrated communication interface“

Appendix: data sheets SCU Master

SCU-1-EC/x SCUSERIES » SCU master



DEVICE INTERFACES

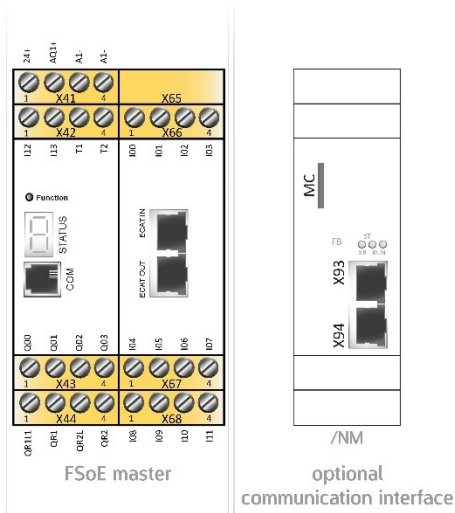

Interface	Description of interface
X41 – X44 / X65 – X68	Voltage supply and I/O interface
COM	Diagnostic and configuration interface
ECAT IN / OUT	Fieldbus interfaces *
X93 / X94	Fieldbus interfaces *

* configurable via SafePLC²

VOLTAGE SUPPLY AND I/O INTERFACE

X41			
Pin	1 - 24+	Voltage supply device +24 VDC	
	2 - AQ1+	Voltage supply device +24 VDC outputs	
	3 - A1- 4 - A1-	Voltage supply device 0 VDC	
X42			
Pin	1 - I12 2 - I13	Safe digital inputs	
	3 - T1 4 - T2	Clock outputs	
	X43		
	Pin	1 - Q00	Safe output pn-/ pp-switching 00
2 - Q01		Safe output pn-/ pp-switching 01	
3 - Q02		Safe output pn-/ pp-switching 02	
4 - Q03		Safe output pn-/ pp-switching 03	
X44			
Pin	1 - QR1L	Safe relay input	
	2 - QR1	Safe relay output	
	3 - QR2L	Safe relay input	
	4 - QR2	Safe relay output	

X65			
Pin	1 - NC 2 - NC 3 - NC 4 - NC	No function	
	X66		
	Pin	1 - I00 2 - I01 3 - I02 4 - I03	Safe digital inputs
		X67	
Pin		1 - I04 2 - I05 3 - I06 4 - I07	Safe digital inputs
		X68	
	Pin	1 - I08 2 - I09 3 - I10 4 - I11	Safe digital inputs

Appendix: data sheets SCU Master

SCU-1-EC/x SCUSERIES » SCU master



DIAGNOSTIC AND CONFIGURATION INTERFACE

Pin assignment

RJ 10, 4-pin		
Pin	Beschreibung	COM front side
1	GND	
2	RS485-	
3	RS485+	
4	VCCH	

» With existing Ethernet-based fieldbus interface, it can be used as a diagnostic and configuration interface.

FIELDBUS INTERFACES

Pin assignment female connector

EtherCAT interface / optional Ethernet-based fieldbus interface (RJ45)				
Pin	Name	Description	Colour	EtherCAT IN/OUT , X93 / X94
1	TX+	Transmit Data +	white-orange	
2	TX-	Transmit Data -	orange	
3	RX+	Receive Data +	white-green	
4	nc	Not used	blue	
5	nc	Not used	white-blue	
6	RX-	Receive Data -	green	
7	nc	Not used	white-brown	
8	nc	Not used	brown	

OPTIONAL INTEGRATED COMMUNICATION INTERFACE

» The optionally integrated communication interface expands the FSoE-Master with a additional safe fieldbus interface (/NM)

General data		
Fieldbus interface	/N	2x RJ 45 *
Memory Card (safety program)	/xM	1x Mini SD (front side)
Status LED's		4

* available field buses: FSoE, PROFIsafe

Appendix: data sheets SCU Master

SCU-1-EC/x

SCU_{SERIES} » SCU master



ORDER INFORMATIONS

FSoE MASTER

item	description	item no.
SCU-1-EC	FSoE Master - modular basic module	1655
SCU-1-EC/NM	FSoE Master + ethernet-based fieldbus interface + Memory Card	2261

ACCESSORIES

item	description	item no.
FSoE License	Field bus license for FSoE	2366
PROFIsafe License	Field bus license for PROFIsafe	2319
SMX91	Programming adapter	1010
SXxxx-x	Terminal connector, screw terminals (set), encoded for cabling SCU-1-EC (/NM)	on request
SXxxx-x	Terminal connector, spring terminals (set), encoded for cabling SCU-1-EC (/NM)	on request

FSoE SLAVES

item	description	item no.
SSB-3-AD-x	Axis expansion module for up to 3 axes + analog / digital	on request
SSB-6-EnDAT-x	Axis expansion module for up to 6 axes + EnDAT 2.2	1656
SSB-6-DSL-x	Axis expansion module for up to 6 axes + HyperfaceDSL	1665
SIO-1	Decentralized IO expansion module	2234
SIO-2	Decentralized IO expansion module	2235
SDU-11	Decentralized axis expansion module for one axis	2394
SDU-11/NM	Decentralized axis expansion module for one axis, safe PROFIsafe / FSoE-slave	2471
SDU-11-PXV	Decentralized axis expansion module for one axis, with safePXV encoder interface	2472
SDU-12	Decentralized axis expansion module for one axis	2395
SDU-21	Decentralized axis expansion module for 2 axes	2396
SDU-22	Decentralized axis expansion module for 2 axes	2397
SDU-21A	Decentralized axis expansion module for 2 axes + Analog Option	2398
SDU-21A-I	Decentralized axis expansion module for 2 axes + Analog Option (current)	2399
SDU-21A-U	Decentralized axis expansion module for 2 axes + Analog Option (voltage)	2400
SDU-22A	Decentralized axis expansion module for 2 axes + Analog Option	2401
SDU-22A-I	Decentralized axis expansion module for 2 axes + Analog Option (current)	2402
SDU-22A-U	Decentralized axis expansion module for 2 axes + Analog Option (voltage)	2403

SOFTWARE

item	description	item no.
SafePLC ² 1st	Programming software, 1te License incl. Hardlock	1244
SafePLC ² 2nd	Programming software, 2te License incl. Hardlock	1646
SafePLC ² 3rd	Programming software, 3te License incl. Hardlock	1647

SCU-2-EC/x

SCUSERIES » SCU Master

BBH
PRODUCTS

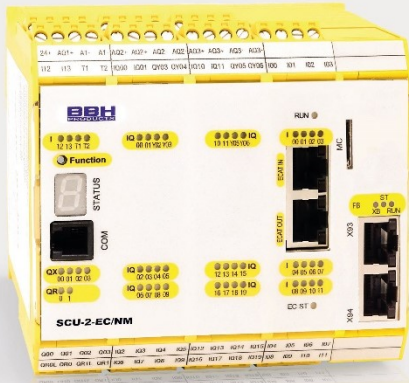

DESCRIPTION

Open programmable and configurable FSoE master unit for operation on EtherCAT networks

- 14 safe digital Inputs
- up to 20 safe digital I/O's
- 2 Relay outputs
- Fast-Channel task for logic processing with a guaranteed response time of 4 ms
- Simple integration of safe drives (Safe Drive Profile)
- Safety controller up to PL e acc. to EN ISO 13849-1 or SIL3 acc. to IEC 61508
- Optional: kinematics module, PROFIsafe / FSoE-Slave stack

CHARACTERISTIC OF THE MODULE

- » Connection of up to 32 FSoE Slave units
- » Safe logic processing of input, output, status and activation signals
- » Simple and transparent programming and parametrization in the EtherCAT environment via SafePLC²
- » Fast response time with integrated Fast Channel Task with guaranteed processing time of 4 ms
- » Central or decentralized drive monitoring possible
- » Complete set of Drive monitoring for single axes and charged axes (based on Kinematics function)
- » Temporary deterministic data communication and processing for safe position and speed functions via distributed sensor / multiple axes
- » Specific profiles for process data exchange and central parametrization that can be adapted to converter/manufacture
- » Safe cross communication (**Safe Master- Master Communication**) for data exchange between FSoE masters via EAP
- » Storage of safe parameters in the basic module
- » Coded status display via front-side 7 segment display and status LEDs
- » Multifunction buttons (quit, start, reset) can be operated from the front side
- » Optional integrated Communication interface :
 - additional field bus interface and PROFIsafe / FSoE-Slave stack for secure connectivity to higher levels of control
 - safe kinematics module for up to 6/12 axes with spatial speed and position monitoring
- » The mechanical structure of SCU-2-EC (/x*) is depended on the respective forms of the base module

* Optional: integrated communication interface (/NM)

SCU-2-EC/x

SCU_{SERIES} » SCU Master



SAFETY RELATED CHARACTERISTIC DATA

Performance Level	PL e (EN ISO 13849-1)
PFH / architecture	PFH = $7,68 \cdot 10^{-9}$
	MTTFd = 280 years = high
	DCavg = high
Safety Integrity Level	SIL 3 (IEC 61508)
Proof test interval	20 years = max. operating period

GENERAL DATA

Max. no. of expansion modules	32
Interface for expansion modules	RJ-45 (Ethernet)
Number of safe digital inputs	14
Number of safe digital outputs	
	pp-switching * 4
	pn-switching * 2
Number of safe digital I/O	20
Number of relay outputs	2
Number of safe analogue inputs	–
Number of auxiliary outputs	–
Number of pulse outputs (clock outputs)	2
Type of connection	Plug-in terminals with spring or screw connection
Cycle time PLC	16 ms
Fast Channel central / SCU	4 ms
Fast Channel decentralized SSB / standard Slave	4 ms
Safe Master	FSoE
Safe Slave **	PROFIsafe / FSoE / CIP Safety
Non-safe Slave	EtherCAT

* pn / pp can be parameterized via SafePLC²

** **optional**: integrated communication interface (/NM)

Appendix: data sheets SCU Master

SCU-2-EC/x
SCU_{SERIES} » SCU Master

BBH
PRODUCTS

ELECTRICAL DATA

Supply voltage (tolerance)		24 VDC (-10%, +15%)
Fuse	24+	min. 30 VDC; max. 3,15A
	AQ1+	min. 30 VDC; max. 10A
Max. Power consumption (logic)	SCU-2-EC/x	3,1 W
Rated data digital inputs		24 VDC; 20 mA Typ1 acc. to IEC 61131-2
Rated data digital outputs		
	pn-switching	24 VDC; 2A *
	pp-switching	24 VDC; 2A *
	pulse outputs (clock outputs)	24 VDC; 250mA
	Digital I/O	00 - 04 10 - 14 05 - 09 15 - 19
		24 VDC; 0,5A 24 VDC; 2A *
Rated data relays		
	Normally open	DC 13 AC 15
		24 VDC; 2A 230 VAC; 2A

DERATING OUTPUTS

- » Maximum current load based on temperature
- » The maximum total current is 10A

type of module	outputs	temperature 30°C / 50°C
SCU-2-EC/x	QX 00 – QX 03	2A / 1,8A

Appendix: data sheets SCU Master

SCU-2-EC/x

SCU_{SERIES} » SCU Master



ENVIRONMENTAL DATA

Temperature	0°C ... +50°C operation
	-25°C ... +70°C storage and transport
Class of protection	IP 20
Climatic category	3K3 acc. to DIN EN 60721-3
Min-, Maximum relative humidity (no condensation)	5% - 85%
EMC	DIN EN 61000-6-2, DIN EN 61000-6-4, DIN EN 61000-6-7, DIN EN 61800-3, DIN EN 61326-3, DIN EN 62061
Operating altitude	2000m

MECHANICAL DATA

Dimensions (HxDxW [mm])	SCU-2-EC	100x115x90
	SCU-2-EC/x *	100x115x112,5
Weight [g]	SCU-2-EC	512
	SCU-2-EC/x *	602
Mounting	to snap on top-hat rail	
Min. terminal cross-section / AWG	0,2 mm ² / 24	
Max. terminal cross-section / AWG	2,5 mm ² / 12	

* Specification, see: „Optional integrated communication interface“

Appendix: data sheets SCU Master

SCU-2-EC/x SCUSERIES » SCU Master



DEVICE INTERFACES

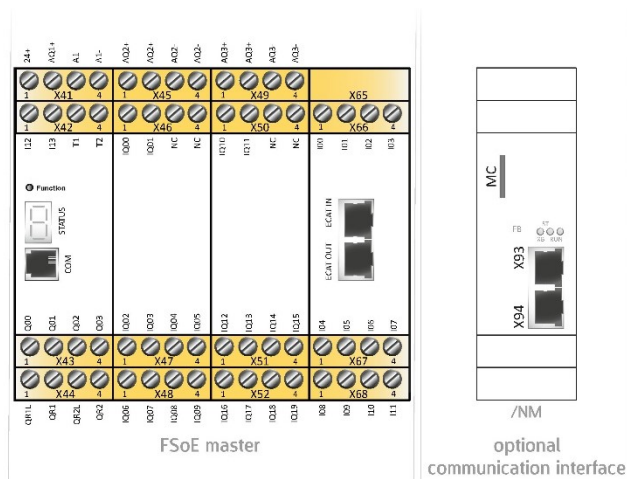

Interface	Description of interface
X41 – X52 / X65 – X68	Voltage supply and I/O interface
COM	Diagnostic and configuration interface
ECAT IN / OUT	Fieldbus interfaces *
X93 / X94	Fieldbus interfaces *

* configurable via SafePLC²

VOLTAGE SUPPLY AND I/O INTERFACE

X41		
Pin	1 - 24+	Voltage supply device +24 VDC
	2 - AQ1+	Voltage supply device +24 VDC outputs
	3 - A1-	Voltage supply device 0 VDC
	4 - A1-	Voltage supply device 0 VDC
X42		
Pin	1 - I12	Safe digital inputs
	2 - I13	
	3 - T1	Clock outputs
	4 - T2	
X43		
Pin	1 - QX00	Safe output pn-/ pp-switching 00
	2 - QX01	Safe output pn-/ pp-switching 01
	3 - QX02	Safe output pn-/ pp-switching 02
	4 - QX03	Safe output pn-/ pp-switching 03
X44		
Pin	1 - QR1L	Safe relay input
	2 - QR1	Safe relay output
	3 - QR2L	Safe relay input
	4 - QR2	Safe relay output

X45		
Pin	1 - AQ2+	Voltage supply device +24 VDC outputs
	2 - AQ2+	
	3 - AQ2-	Voltage supply 0 VDC
	4 - AQ2-	
X46		
Pin	1 - IQ00	Safe digital inputs / outputs
	2 - IQ01	
	3 - NC	No function
	4 - NC	
X47		
Pin	1 - IQ02	safe digital inputs / outputs
	2 - IQ03	
	3 - IQ04	
	4 - IQ05	
X48		
Pin	1 - IQ06	safe digital inputs / outputs
	2 - IQ07	
	3 - IQ08	
	4 - IQ09	

Appendix: data sheets SCU Master

SCU-2-EC/x
 SCU_{SERIES} » SCU Master



X49		
Pin	1 - AQ3+	Voltage supply device +24 VDC outputs
	2 - AQ3+	
	3 - AQ3-	Voltage supply device 0 VDC
	4 - AQ3-	
X50		
Pin	1 - IQ10	Safe digital inputs / outputs
	2 - IQ11	
	3 - NC	No function
	4 - NC	
X51		
Pin	1 - IQ12	Safe digital inputs / outputs
	2 - IQ13	
	3 - IQ14	
	4 - IQ15	
X52		
Pin	1 - IQ16	Safe digital inputs / outputs
	2 - IQ17	
	3 - IQ18	
	4 - IQ19	

X65		
Pin	1 - NC	No function
	2 - NC	
	3 - NC	
	4 - NC	
X66		
Pin	1 - I00	Safe digital inputs
	2 - I01	
	3 - I02	
	4 - I03	
X67		
Pin	1 - I04	Safe digital inputs
	2 - I05	
	3 - I06	
	4 - I07	
X68		
Pin	1 - I08	Safe digital inputs
	2 - I09	
	3 - I10	
	4 - I11	

Appendix: data sheets SCU Master

SCU-2-EC/x SCUSERIES » SCU Master



DIAGNOSTIC AND CONFIGURATION INTERFACE

Pin assignment

RJ 10, 4-pin		
Pin	Beschreibung	COM front side
1	GND	
2	RS485-	
3	RS485+	
4	VCCH	

» With existing Ethernet-based fieldbus interface, it can be used as a diagnostic and configuration interface.

FIELDBUS INTERFACES

Pin assignment female connector

EtherCAT interface / optional Ethernet-based fieldbus interface (RJ45)				
Pin	Name	Description	Colour	EtherCAT IN/OUT , X93 / X94
1	TX+	Transmit Data +	white-orange	
2	TX-	Transmit Data -	orange	
3	RX+	Receive Data +	white-green	
4	nc	Nicht genutzt	blue	
5	nc	Nicht genutzt	white-blue	
6	RX-	Receive Data -	green	
7	nc	Nicht genutzt	white-brown	
8	nc	Nicht genutzt	brown	

OPTIONAL INTEGRATED COMMUNICATION INTERFACE

» The optionally integrated communication interface expands the FSoE-Master with a additional safe fieldbus interface (/NM)

General data		
Fieldbus interface	/N	2x RJ 45 *
Memory Card (safety program)	/xM	1x Mini SD (front side)
Status LED's		4

* available field buses: FSoE, PROFIsafe

Appendix: data sheets SCU Master

SCU-2-EC/x

SCU_{SERIES} » SCU Master



ORDER INFORMATIONS

FSoE MASTER

item	description	item no.
SCU-2-EC	FSoE Master - modular basic module with 20 safe digital I/O's	1693
SCU-2-EC/NM	FSoE Master + ethernet-based fieldbus interface + Memory Card	2393

ACCESSORIES

item	description	item no.
FSoE License	Field bus license for FSoE	2366
PROFIsafe License	Field bus license for PROFIsafe	2319
SMX91	Programming adapter	1010
SXxxx-x	Terminal connector, screw terminals (set), encoded for cabling SCU-2-EC (/NM)	on request
SXxxx-x	Terminal connector, spring terminals (set), encoded for cabling SCU-2-EC (/NM)	on request

FSoE SLAVES

item	description	item no.
SSB-3-AD-x	Axis expansion module for up to 3 axes + analog / digital	on request
SSB-6-EnDAT-x	Axis expansion module for up to 6 axes + EnDAT 2.2	1656
SSB-6-DSL-x	Axis expansion module for up to 6 axes + HyperfaceDSL	1665
SIO-1	Decentralized IO expansion module	2234
SIO-2	Decentralized IO expansion module	2235
SDU-11	Decentralized axis expansion module for one axis	2394
SDU-11/NM	Decentralized axis expansion module for one axis, safe PROFIsafe / FSoE-slave	2471
SDU-11-PXV	Decentralized axis expansion module for one axis, with safePXV encoder interface	2472
SDU-12	Decentralized axis expansion module for one axis	2395
SDU-21	Decentralized axis expansion module for 2 axes	2396
SDU-22	Decentralized axis expansion module for 2 axes	2397
SDU-21A	Decentralized axis expansion module for 2 axes + Analog Option	2398
SDU-21A-I	Decentralized axis expansion module for 2 axes + Analog Option (current)	2399
SDU-21A-U	Decentralized axis expansion module for 2 axes + Analog Option (voltage)	2400
SDU-22A	Decentralized axis expansion module for 2 axes + Analog Option	2401
SDU-22A-I	Decentralized axis expansion module for 2 axes + Analog Option (current)	2402
SDU-22A-U	Decentralized axis expansion module for 2 axes + Analog Option (voltage)	2403

SOFTWARE

item	description	item no.
SafePLC ² 1st	Programming software, 1te License incl. Hardlock	1244
SafePLC ² 2nd	Programming software, 2te License incl. Hardlock	1646
SafePLC ² 3rd	Programming software, 3te License incl. Hardlock	1647

SDU-11

SCU_{SERIE} » SCU Slaves



DESCRIPTION

FSoE slave module for safe speed and position of 1 axis for further evaluation in an FSoE master module

- 14 Safe digital inputs
- Up to 4 safe digital outputs
- 2 Encoder interfaces
- 2 Relay / Pulse outputs
- 2 Auxiliary outputs
- Safety controller up to PL e acc. to EN ISO 13849-1 or SIL3 acc. to IEC 61508

CHARACTERISTIC OF THE MODULE

- » Decentralized safe axle assembly for the EtherCAT environment
- » Safe detection of speed and position of one axis
- » Fast response time via integrated Fast Channel Task with guaranteed processing time of 2 ms
- » Complete speed and position-related safety functions for drive monitoring IEC 61800-5-2 integrated into firmware
- » Speed monitoring
- » RPM-monitoring
- » Standstill monitoring
- » Sense of rotation monitoring
- » Safe incremental dimension
- » Emergency Stop monitoring
- » Position monitoring
- » Position range monitoring
- » Trend range monitoring
- » Target position monitoring
- » Pulse outputs for cross-shortening detection of digital input signals
- » External contact monitoring of connected switchgear (EMU)
- » Monitored relay outputs for safety-relevant functions
- » Switchable safe semi-conductor outputs pn-, pp-switching for safety-relevant functions
- » Functionplan-oriented parametrization
- » Parameter management for expansion modules in base device
- » Comprehensive diagnostics functions integrated
- » Coded status display via front-side 7 segment display and status LEDs

SDU-11

SCU_{SERIES} » SCU Slaves



SAFETY RELATED CHARACTERISTIC DATA

Performance Level	PL e (EN ISO 13849-1)
PFH / architecture	$2,0 * 10^{-9}$ / Cat 4
Safety Integrity Level	SIL 3 (IEC 61508)
Proof test interval	20 years = max. operating period

GENERAL DATA

Max. no. of expansion modules	–
Interface for expansion modules	RJ-45 (Ethernet)
Number of safe digital inputs	14
Number of safe digital outputs	
	pp-switching * 4
	pn-switching * 2
Number of safe digital I/O	–
Number of relay outputs	2
Number of safe analogue inputs	–
Number of auxiliary outputs	2
Number of pulse outputs (clock outputs)	2
Type of connection	Plug-in terminals with spring or screw connection
Axis monitoring	1
Encoder interfaces (D-Sub / screw terminals)	1 / 1 **
Encoder technology (See Encoder specifications)	D-SUB Enc 1.1: SSI-Absolut, SinCos, Incremental-TTL
	Terminal X23: HTL proximity sensor (10kHz)
Cycle time PLC	8 ms
Fast Channel	2 ms
Safe Slave	FSoE

* pn/pp are configurable via SafePLC²

** maximum 2 encoder / axis

Appendix: data sheets SCU Slaves

SDU-11
SCU_{SERIES} » SCU Slaves

BBH
PRODUCTS

ELECTRICAL DATA

Supply voltage (tolerance)		24 VDC; 2A (-10%, +20%)
Fuse	X11.1 / 24+	min. 30 VDC; max. 3,15A
	X11.2 / AQ1+	min. 30 VDC; max. 10A
Max. Power consumption (logic)	SDU-11	5,2 W
Rated data digital inputs		24 VDC; 20 mA Typ1 acc. to IEC 61131-2
Rated data digital outputs		
	pn-switching	24 VDC; 2A
	pp-switching	24 VDC; 2A
	auxiliary outputs	24 VDC; 250mA
	pulse outputs (clock outputs)	24 VDC; 250mA
Rated data relays		
Normally open	DC 13	24 VDC; 2A
	AC 15	230 VAC; 2A

DERATING OUTPUTS

- » Maximum current load based on temperature.
- » The maximum total current is 10A.

type of module	outputs	temperature 30°C / 50°C
SDU-11	QX 00 – QX 03	2A / 1,8A

2A outputs can be fully loaded at an ambient temperature of up to 30°C. From a ambient temperature from 30°C to maximum 50°C, the 2A outputs can be loaded to a maximum of 1.8A.

The maximum total current is 10A. (IO-Board)

Appendix: data sheets SCU Slaves

SDU-11 SCU_{SERIES} » SCU Slaves



ENVIRONMENTAL DATA

Temperature	0°C ... +50°C operation -25°C ... +70°C storage and transport
Class of protection	IP 20
Climatic category	3K3 acc. to DIN EN 60721-3
Min-, Maximum relative humidity (no condensation)	5% - 85%
EMC	DIN EN 61000-6-2, DIN EN 61000-6-4, DIN EN 61000-6-7, DIN EN 61800-3, DIN EN 61326-3, DIN EN 62061
Operating altitude	2000m

MECHANICAL DATA

Dimension (HxDxW [mm])	SDU-11	100x115x67,5
Weight [g]	SDU-11	390
Mounting		to snap on top-hat rail
Min. terminal cross-section / AWG		0,2 mm ² / 24
Max. terminal cross-section / AWG		2,5 mm ² / 12

Appendix: data sheets SCU Slaves

SDU-11 SCUSERIES » SCU Slaves



DEVICE INTERFACES

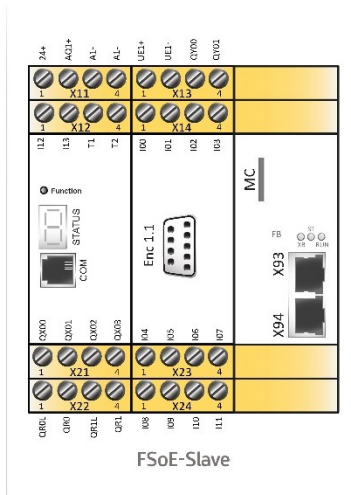

Interface	Description of interface
X11 – X14 / X21 – X24	Voltage supply and I/O interface
COM	Diagnostic- and configuration interface
X93 - ECAT IN / X94 - ECAT OUT	Fieldbus interfaces
I04 - I07 / Enc 1.1	Encoder interfaces

VOLTAGE SUPPLY AND I/O INTERACE

X11		
Pin	1 - 24+	Voltage supply device +24 VDC
	2 - AQ1+	Voltage supply device +24 VDC outputs
	3 - A1-	Voltage supply device 0 VDC
	4 - A1-	Voltage supply device 0 VDC
X12		
Pin	1 - I12	Safe digital inputs
	2 - I13	
	3 - T1	Clock outputs
	4 - T2	
X21		
Pin	1 - QX00	Safe output pn-/ pp-switching 00
	2 - QX01	Safe output pn-/ pp-switching 01
	3 - QX02	Safe output pn-/ pp-switching 02
	4 - QX03	Safe output pn-/ pp-switching 03
X22		
Pin	1 - QR0L	Safe relay input
	2 - QR0	Safe relay output
	3 - QR1L	Safe relay input
	4 - QR1	Safe relay output

X13		
Pin	1 - UE1+	Voltage supply encoder +24 VDC
	2 - UE1-	
	3 - QY00	Auxiliary outputs
	4 - QY01	
X14		
Pin	1 - I00	Safe digital inputs
	2 - I01	
	3 - I02	
	4 - I03	
X23		
Pin	1 - I04	Safe digital inputs
	2 - I05	
	3 - I06	
	4 - I07	
X24		
Pin	1 - I08	Safe digital inputs
	2 - I09	
	3 - I10	
	4 - I11	

Appendix: data sheets SCU Slaves

SDU-11

SCU_{SERIES} » SCU Slaves

BBH
PRODUCTS

DIAGNOSTIC AND CONFIGURATION INTERFACE

Pin assignment

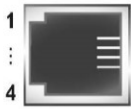
RJ 10, 4-pin		
Pin	Description	COM front side
1	GND	
2	RS485-	
3	RS485+	
4	VCCH	

» With existing Ethernet-based fieldbus interface, it can be used as a diagnostic and configuration interface.

FIELDBUS INTERFACES

Pin assignment, ethernet-based interface

EtherCAT interface (RJ45)				
Pin	Name	Description	Colour	X93 / X94
1	TX +	Transmit Data +	white-orange	
2	TX -	Transmit Data -	orange	
3	RX +	Receive Data +	white-green	
4	nc	Not used	blue	
5	nc	Not used	white-blue	
6	RX -	Receive Data -	green	
7	nc	Not used	white-brown	
8	nc	Not used	brown	

INTEGRATED COMMUNICATION INTERFACE

» The integrated communication interface of the FSoE slave includes a safe EtherCAT interface for decentralized communication with an FSoE-Master unit.

General data

Fieldbus interface	X93 / X94	EtherCAT	2x RJ 45
Memory Card (safety program)	MC		1x Mini SD (front side)
Status LED's			3

SDU-11 SCU_{SERIES} » SCU Slaves



ENCODER INTERFACES

Pin assignment Enc 1.1

Pin	Inc / Sin/Cos / SSI	Front side SDU
1	n.c.	
2	GND_ENC	
3	n.c.	
4	B - / COS - / Clk -	
5	A + / SIN + / Data +	
6	A - / SIN - / Data -	
7	n.c.	
8	B + / COS + / Clk +	
9	U_ENC	

Pin assignment X23

Pin	Z1 - Z1 / Z2 - Z2	Terminal
1	A (\bar{A}) / A (\bar{A})	
2	-- / B (\bar{B})	
3	A (\bar{A}) / A (\bar{A})	
4	-- / B (\bar{B})	

ENCODER SPECIFICATIONS

Incremental - TTL	
Physical Layer	RS-422 compatible
Measuring signal A/B	Track with 90 degree phase difference
Type of connection	D-SUB 9pole
Max. frequency of input cycles (X31)	200 kHz
Sin/Cos	
Physical Layer	RS-422 compatible
Measuring signal A/B	Track with 90 degree phase difference
Type of connection	D-SUB 9pole
Standard Mode	
Max. frequency of input clock pulses (X31)	200 kHz
High Resolution Mode	
Max. frequency of input clock pulses (X31)	-
SSI-Absolut	
Data interface	Serial Synchronous Interface (SSI) with variable data length of 12 – 28 Bit
Data format	Binary, Gray code
Physical Layer	RS-422 compatible
Type of connection	D-SUB 9pole
Mode	Listener
SSI Listener Mode	
Clock rate (Enc 1.1.)	100 kHz ... 250 kHz
Min. clock pause time	150 µsec
Max. clock pause time	1 msec
HTL proximity sensor	
Signal level	24V / 0V
Max. counting pulse frequency (circuit logic de-bounced)	10 kHz
Pulse width	50 µsec
Type of connection (X23)	Plug-in terminals with spring or screw connection
HTL proximity switch - extended monitoring	
Signal level	24V / 0V
Max. counting frequency (circuit logic de-bounced)	4 kHz
Physical Layer	PUSH / PULL
Measuring signal A/B	Track with 90 degree phase difference
Type of connection (X23)	Plug-in terminals with spring or screw connection

Appendix: data sheets SCU Slaves

SDU-11

SCU_{SERIES} » SCU Slaves



ORDER INFORMATION

FSoE SLAVES

item	description	item no.
SDU-11	Decentralized axis expansion module for one axis	2394

ACCESSORIES

item	description	item no.
SMX91	Programming adapter	1010
SXxxx-x	Terminal connector, screw terminals (set), encoded for cabling SDU-11	on request
SXxxx-x	Terminal connector, spring terminals (set), encoded for cabling SDU-11	on request

SOFTWARE

item	description	item no.
SafePLC ² 1st	Programming software, 1te License incl. Hardlock	1244
SafePLC ² 2nd	Programming software, 2te License incl. Hardlock	1646
SafePLC ² 3rd	Programming software, 3te License incl. Hardlock	1647

SDU-11/NM

SCUSERIE » SCU Slaves



DESCRIPTION

EtherCAT/PROFINET slave module for safe speed and Position of 1 axis for further evaluation in an master device.

- 14 safe digital inputs
- 3 Encoder interfaces
- 2 Relay / pulse outputs
- 2 Auxiliary outputs
- Up to 4 safe digital outputs
- 1 additional fieldbus interface
- Safety controller up to PL e acc. to EN ISO 13849-1 or SIL3 acc. to IEC 61508

CHARACTERISTIC OF THE MODULE

- » Decentralized safe axle assembly for the EtherCAT environment
- » Safe detection of speed and position from one axis
- » Complete speed and position-related safety functions for drive monitoring IEC 61800-5-2 integrated into firmware
- » Speed monitoring
- » RPM-monitoring
- » Standstill monitoring
- » Sense of rotation monitoring
- » Safe incremental dimension
- » Emergency Stop monitoring
- » Position monitoring
- » Position range monitoring
- » Trend range monitoring
- » Target position monitoring
- » Pulse outputs for cross-shorting detection of digital input signals
- » External contact monitoring of connected switchgear (EMU)
- » Monitored relay outputs for safety-relevant functions
- » Switchable safe semi-conductor outputs pn-, pp-switching for safety-relevant functions
- » Functionplan-oriented parametrization
- » Parameter management for expansion modules in base device
- » Comprehensive diagnostics functions integrated
- » Multifunction button (Quit, Start, Reset) can be operated from the front side
- » Coded status display via front-side 7 segment display and status LEDs
- » Additional fieldbus interface: EtherCAT, PROFINET

Appendix: data sheets SCU Slaves

SDU-11/NM

SCU_{SERIES} » SCU Slaves



SAFETY RELATED CHARACTERISTIC DATA

Performance Level	PL e (EN ISO 13849-1)
PFH / architecture	$2,0 * 10^{-9}$ / Cat 4
Safety Integrity Level	SIL 3 (IEC 61508)
Proof test interval	20 years = max. operating period

GENERAL DATA

Max. no. of expansion modules	–
Interface for expansion modules	–
Number of safe digital inputs	14
Number of safe digital outputs	
	pp-switching * 4
	pn-switching * 2
Number of safe digital I/O	–
Number of relay outputs	2
Number of safe analogue inputs	–
Number of auxiliary outputs	2
Number of pulse outputs (clock outputs)	2
Type of connection	Plug-in terminals with spring or screw connection
Axis monitoring	1
Encoder interfaces (D-Sub / screw terminals/ virtual EtherCAT-interface)	1 / 1 / 1 **
Encoder technology (See Encoder specifications)	D-SUB Enc 1.1: SSI-Absolut, SinCos, Incremental-TTL Terminal X23: HTL proximity sensor (10kHz) Fieldbus: speed and position via EtherCAT
Cycle time PLC	8 ms
Fast Channel	2 ms
Safe Slave	PROFIsafe

* pn/pp are configurable via SafePLC²

** maximum 2 encoder / axis

Appendix: data sheets SCU Slaves

SDU-11/NM

SCU_{SERIES} » SCU Slaves



ELECTRICAL DATA

Supply voltage (tolerance)		24 VDC; 2A (-10%, +20%)
Fuse	X11.1 / 24+	min. 30 VDC; max. 3,15A
	X11.2 / AQ1+	min. 30 VDC; max. 10A
Max. Power consumption (logic)	SDU-11/NM	5,2 W
Rated data digital inputs		24 VDC; 20 mA Typ1 acc. to IEC 61131-2
Rated data digital outputs		
	pn-switching	24 VDC; 2A
	pp-switching	24 VDC; 2A
	auxiliary outputs	24 VDC; 250mA
	pulse outputs (clock outputs)	24 VDC; 250mA
Rated data relays		
	Normally open	DC 13
		24 VDC; 2A
		AC 15
		230 VAC; 2A

DERATING OUTPUTS

- » Maximum current load based on temperature.
- » The maximum total current is 10A.

type of module	outputs	temperature 30°C / 50°C
SDU-11/NM	QX 00 – QX 03	2A / 1,8A

2A outputs can be fully loaded at an ambient temperature of up to 30°C. From a ambient temperature from 30°C to maximum 50°C, the 2A outputs can be loaded to a maximum of 1.8A.

The maximum total current is 10A. (IO-Board)

Appendix: data sheets SCU Slaves

SDU-11/NM

SCU_{SERIES} » SCU Slaves



ENVIRONMENTAL DATA

Temperature	0°C ... +50°C operation
	-25°C ... +70°C storage and transport
Class of protection	IP 20
Climatic category	3K3 acc. to DIN EN 60721-3
Min-, Maximum relative humidity (no condensation)	5% - 85%
EMC	DIN EN 61000-6-2, DIN EN 61000-6-4, DIN EN 61000-6-7, DIN EN 61800-3, DIN EN 61326-3, DIN EN 62061
Operating altitude	2000m

MECHANICAL DATA

Dimension (HxDxW [mm])	SDU-11/NM	100x115x67,5
Weight [g]	SDU-11/NM	390
Mounting		to snap on top-hat rail
Min. terminal cross-section / AWG		0,2 mm ² / 24
Max. terminal cross-section / AWG		2,5 mm ² / 12

Appendix: data sheets SCU Slaves

SDU-11/NM SCUSERIES » SCU Slaves



DEVICE INTERFACES

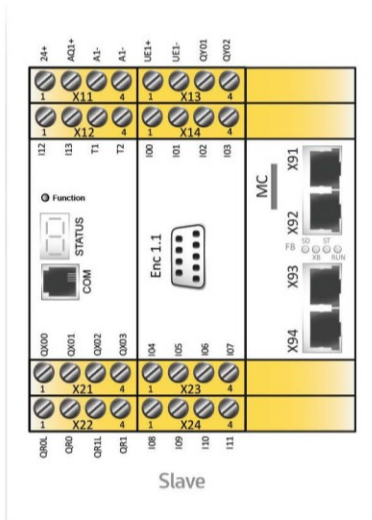

Interface	Description of interface
X11 – X14 / X21 – X24	Voltage supply and I/O interface
COM	Diagnostic- and configuration interface
X91 - ECAT IN / X92 - ECAT OUT	Fieldbus interface
X93 / X94	Fieldbus interfaces *
X23 / Enc 1.1	Encoder interfaces

* configurable via SafePLC?

VOLTAGE SUPPLY AND I/O INTERACE

X11		
Pin	1 - 24+	Voltage supply device +24 VDC
	2 - AQ1+	Voltage supply device +24 VDC outputs
	3 - A1-	Voltage supply device 0 VDC
	4 - A1-	
X12		
Pin	1 - I12	Safe digital inputs
	2 - I13	
	3 - T1	Clock outputs
	4 - T2	
X21		
Pin	1 - QX00	Safe output pn-/ pp-switching 00
	2 - QX01	Safe output pn-/ pp-switching 01
	3 - QX02	Safe output pn-/ pp-switching 02
	4 - QX03	Safe output pn-/ pp-switching 03
X22		
Pin	1 - QR0L	Safe relay input
	2 - QR0	Safe relay output
	3 - QR1L	Safe relay input
	4 - QR1	Safe relay output

X13		
Pin	1 - UE1+	Voltage supply +24 VDC encoder
	2 - UE1-	
	3 - QY01	Auxiliary outputs
	4 - QY02	
X14		
Pin	1 - I00	Safe digital inputs
	2 - I01	
	3 - I02	
	4 - I03	
X23		
Pin	1 - I04	Safe digital inputs
	2 - I05	
	3 - I06	
	4 - I07	
X24		
Pin	1 - I08	Safe digital inputs
	2 - I09	
	3 - I10	
	4 - I11	

Appendix: data sheets SCU Slaves

SDU-11/NM

SCU SERIES » SCU Slaves



DIAGNOSTIC AND CONFIGURATION INTERFACE

Pinbelegung

RJ 10, 4-pin		
Pin	Description	COM front side
1	GND	
2	RS485-	
3	RS485+	
4	VCCH	

» With existing Ethernet-based fieldbus interface, it can be used as a diagnostic and configuration interface.

FIELD BUS INTERFACES

Pin assignment female connector

EtherCAT interface and safe fieldbus interface (RJ45)				
Pin	Name	Description	Colour	X91 / X92 , X93 / X94
1	TX+	Transmit Data +	white-orange	
2	TX-	Transmit Data -	orange	
3	RX+	Receive Data +	white-green	
4	nc	Not used	blue	
5	nc	Not used	white-blue	
6	RX-	Receive Data -	green	
7	nc	Not used	white-brown	
8	nc	Not used	brown	

INTEGRATED COMMUNICATION INTERFACE

» The integrated communication interface includes an EtherCAT interface and one interface for ethernet-based fieldbuses or safe interface (PROFIsafe) for decentralized communication with a master device.

General data

Fieldbus interfaces

X91 / X92	EtherCAT	2x RJ 45
X93 / X94	/N	2x RJ 45*

Memory Card (safety program)

/xM	1x Mini SD (front side)
-----	-------------------------

Status LED`s	3
--------------	---

* available fieldbuses: EtherCAT, EtherNet/IP, Modbus TCP/IP and PROFINET / PROFIsafe

SDU-11/NM

SCU_{SERIES} » SCU Slaves



ENCODER INTERFACES

Pin assignment Enc 1.1

Pin	Inc / Sin/Cos / SSI	Front side SDU
1	n.c.	
2	GND_ENC	
3	n.c.	
4	B- / COS - / Clk -	
5	A+ / SIN+ / Data +	
6	A- / SIN - / Data -	
7	n.c.	
8	B+ / COS + / Clk +	
9	U_ENC	

Pin assignment X23

Pin	Z1 - Z1 / Z2 - Z2	Terminal
1	A (\bar{A}) / A (\bar{A})	
2	-- / B (\bar{B})	
3	A (\bar{A}) / A (\bar{A})	
4	-- / B (\bar{B})	

ENCODER SPECIFICATIONS

Incremental - TTL	
Physical Layer	RS-422 compatible
Measuring signal A/B	Track with 90 degree phase difference
Type of connection	D-SUB 9pole
Max. frequency of input cycles (X31)	200 kHz
Sin/Cos	
Physical Layer	RS-422 compatible
Measuring signal A/B	Track with 90 degree phase difference
Type of connection	D-SUB 9pole
Standard Mode	
Max. frequency of input clock pulses (X31)	200 kHz
High Resolution Mode	
Max. frequency of input clock pulses (X31)	-
SSI-Absolut	
Data interface	Serial Synchronous Interface (SSI) with variable data length of 12 – 28 Bit
Data format	Binary, Gray code
Physical Layer	RS-422 compatible
Type of connection	D-SUB 9pole
Mode	Listener
SSI Listener Mode	
Clock rate (Enc 1.1.)	100 kHz ... 250 kHz
Min. clock pause time	150 µsec
Max. clock pause time	1 msec
HTL proximity sensor	
Signal level	24V / 0V
Max. counting pulse frequency (circuit logic de-bounced)	10 kHz
Pulse width	50 µsec
Type of connection (X23)	Plug-in terminals with spring or screw connection
HTL proximity switch - extended monitoring	
Signal level	24V / 0V
Max. counting frequency (circuit logic de-bounced)	4 kHz
Physical Layer	PUSH / PULL
Measuring signal A/B	Track with 90 degree phase difference
Type of connection (X23)	Plug-in terminals with spring or screw connection

Appendix: data sheets SCU Slaves

SDU-11/NM

SCU_{SERIES} » SCU Slaves

BBH
PRODUCTS

ORDER INFORMATION

SLAVE DEVICE

item	description	item no.
SDU-11/NM	Decentralised axis expansion module for one axis with additional fieldbus interface	2471

ACCESSORIES

item	description	item no.
SMX91	Programming adapter	1010
PROFIsafe License	Fieldbus license for PROFIsafe	2319
SXxxx-x	Terminal connector, screw terminals (set), encoded for cabling SDU-11/NM	on request
SXxxx-x	Terminal connector, spring terminals (set), encoded for cabling SDU-11/NM	on request

SOFTWARE

item	description	item no.
SafePLC ² 1st	Programming software, 1te License incl. Hardlock	1244
SafePLC ² 2nd	Programming software, 2te License incl. Hardlock	1646
SafePLC ² 3rd	Programming software, 3te License incl. Hardlock	1647

SDU-11-PXV

SCU_{SERIE} » SCU Slaves

BBH
PRODUCTS



DESCRIPTION

FSoE slave module for safe speed and position of 1 axis for further evaluation in an FSoE master module

- With integrated safePXV-Encoder interface
- 14 Safe digital inputs
- 2 Relay / pulse outputs
- 2 Auxiliary outputs
- Up to 4 safe digital outputs
- Safety control up to PL e acc. to EN ISO 13849-1 or SIL3 acc. to IEC 61508

CHARACTERISTIC OF THE MODULE

- » Decentralized safe axle assembly for the EtherCAT environment
- » Safe detection of speed and position of one axis
- » Complete speed and position-related safety functions for drive monitoring IEC 61800-5-2 integrated into firmware
- » Safe position monitoring with only one sensor in combination with the optical reading head PXV100AS-F200-R4-V19-BBH
- » Speed monitoring
- » RPM-monitoring
- » Standstill monitoring
- » Direction monitoring
- » Safe incremental dimension
- » Emergency Stop monitoring
- » Position monitoring
- » Position range monitoring
- » Trend range monitoring
- » Target position monitoring
- » Pulse outputs for cross-shortening detection of digital input signals
- » External contact monitoring of connected switchgear (EMU)
- » Monitored relay outputs for safety-relevant functions
- » Switchable safe semi-conductor outputs pn-, pp-switching for safety-relevant functions
- » Functionplan-oriented parametrization
- » Parameter management for expansion modules in base device
- » Comprehensive diagnostics functions integrated
- » Multifunction button (quit, start, reset) can be operated from the front side
- » Coded status display via front-side 7 segment display and status LEDs
- » Extended functionality: safePXV-encoder interface

Appendix: data sheets SCU Slaves

SDU-11-PXV

SCU_{SERIES} » SCU Slaves



SAFETY RELATED CHARACTERISTIC DATA

Performance Level	PL e (EN ISO 13849-1)
PFH / architecture	$2,0 * 10^{-9}$ / Cat 4
Safety Integrity Level	SIL 3 (IEC 61508)
Proof test interval	20 years = max. operating period

GENERAL DATA

Max. no. of expansion modules	–
Interface for expansion modules	–
Number of safe digital inputs	14
Number of safe digital outputs	
	pp-switching * 4
	pn-switching * 2
Number of safe digital I/O	–
Number of relay outputs	2
Number of safe analogue inputs	–
Number of auxiliary outputs	2
Number of pulse outputs (clock outputs)	2
Type of connection	Plug-in terminals with spring or screw connection
Axis monitoring	1
Encoder interfaces (M12)	1
Encoder technology (See Encoder specifications)	RS 485, ENC 1.5: PXV100AS-F200-R4-V19-BBH
Cycle time PLC	8 ms
Fast Channel	2 ms
Safe Slave	FSoE

* pn/pp are configurable via SafePLC²

Appendix: data sheets SCU Slaves

SDU-11-PXV

SCU_{SERIES} » SCU Slaves

BBH
PRODUCTS

ELECTRICAL DATA

Supply voltage (tolerance)		24 VDC; 2A (-10%, +20%)
Fuse	X11.1 / 24+	min. 30 VDC; max. 3,15A
	X11.2 / AQ1+	min. 30 VDC; max. 10A
Max. Power consumption (logic)	SDU-11-PXV	5,2 W
Rated data digital inputs		24 VDC; 20 mA Typ1 acc. to IEC 61131-2
Rated data digital outputs		
	pn-switching	24 VDC; 2A
	pp-switching	24 VDC; 2A
	auxiliary outputs	24 VDC; 250mA
	pulse outputs (clock outputs)	24 VDC; 250mA
Rated data relays		
	Normally open	DC 13
		24 VDC; 2A
		AC 15
		230 VAC; 2A

DERATING OUTPUTS

- » Maximum current load based on temperature.
- » The maximum total current is 10A.

type of module	outputs	temperature 30°C / 50°C
SDU-11-PXV	QX 00 – QX 03	2A / 1,8A

2A outputs can be fully loaded at an ambient temperature of up to **30°C**.
From a ambient temperature from **30°C** to maximum **50°C**, the 2A outputs
 can be loaded to a maximum of **1.8A**.

The maximum total current is **10A**. (IO-Board)

Appendix: data sheets SCU Slaves

SDU-11-PXV

SCU_{SERIES} » SCU Slaves



ENVIRONMENTAL DATA

Temperature	0°C ... +50°C operation
	-25°C ... +70°C storage and transport
Class of protection	IP 20
Climatic category	3K3 acc. to DIN EN 60721-3
Min-, Maximum relative humidity (no condensation)	5% - 85%
EMC	DIN EN 61000-6-2, DIN EN 61000-6-4, DIN EN 61000-6-7, DIN EN 61800-3, DIN EN 61326-3, DIN EN 62061
Operating altitude	2000m

MECHANICAL DATA

Dimension (HxDxW [mm])	SDU-11-PXV	100x115x90
Weight [g]	SDU-11-PXV	490
Mounting		to snap on top-hat rail
Min. terminal cross-section / AWG		0,2 mm ² / 24
Max. terminal cross-section / AWG		2,5 mm ² / 12

Appendix: data sheets SCU Slaves

SDU-11-PXV SCU SERIES » SCU Slaves



DEVICE INTERFACES

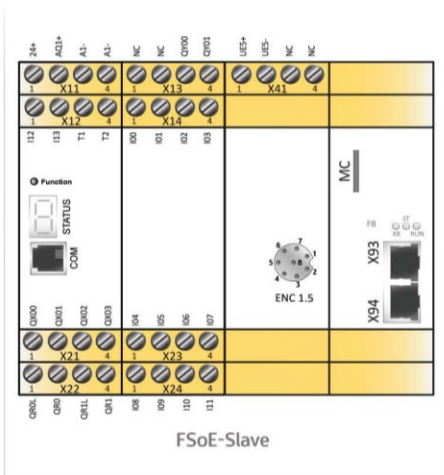

Interface	Description of interface
X11 – X14 / X21 – X24 / X41	Voltage supply and I/O interface
MC	Memory Card for safety program
COM	Diagnostic- and configuration interface
X93 - ECAT IN / X94 - ECAT OUT	Fieldbus interface
ENC 1.5	Encoder interface

VOLTAGE SUPPLY AND I/O INTERACE

X11			
Pin	1 - 24+	Voltage supply device +24 VDC	
	2 - AQ1+	Voltage supply device +24 VDC outputs	
	3 - A1- 4 - A1-	Voltage supply device 0 VDC	
X12			
Pin	1 - I12 2 - I13	Safe digital inputs	
	3 - T1 4 - T2	Clock outputs	
	X21		
	Pin	1 - QX00 2 - QX01 3 - QX02 4 - QX03	Safe output pn-/ pp-switching 00 Safe output pn-/ pp-switching 01 Safe output pn-/ pp-switching 02 Safe output pn-/ pp-switching 03
X22			
Pin		1 - QR0L 2 - QR0 3 - QR1L 4 - QR1	Safe relay input Safe relay output Safe relay input Safe relay output

X13			
Pin	1 - NC 2 - NC	No function	
	3 - QY01 4 - QY02	Auxiliary outputs	
	X14		
	Pin	1 - I00 2 - I01 3 - I02 4 - I03	Safe digital inputs
X23			
Pin		1 - I04 2 - I05 3 - I06 4 - I07	Safe digital inputs
		X24	
	Pin	1 - I08 2 - I09 3 - I10 4 - I11	Safe digital inputs
		X41	
Pin		1 - UE5+ 3 - UE5- 4 - NC 5 - NC	Voltage supply Sensor +24 VDC Voltage supply Sensor 0 VDC No function No function

Appendix: data sheets SCU Slaves

SDU-11-PXV

SCU_{SERIES} » SCU Slaves



DIAGNOSTIC AND CONFIGURATION INTERFACE

Pin assignment

RJ 10, 4-pin		
Pin	Description	COM front side
1	GND	
2	RS485-	
3	RS485+	
4	VCCH	

» With existing Ethernet-based fieldbus interface, it can be used as a diagnostic and configuration interface.

FIELDBUS INTERFACES

Pin assignment, ethernet-based interface

Safe EtherCAT interface (RJ45)				
Pin	Name	Description	Colour	X93 / X94
1	TX+	Transmit Data +	white-orange	
2	TX-	Transmit Data -	orange	
3	RX+	Receive Data +	white-green	
4	nc	Not used	blue	
5	nc	Not used	white-blue	
6	RX-	Receive Data -	green	
7	nc	Not used	white-brown	
8	nc	Not used	brown	

INTEGRATED COMMUNICATION INTERFACE

» The integrated communication interface of the FSoE-slave includes a safe EtherCAT interface for decentralized communication with an FSoE-master unit.

General data			
Fieldbus interface			
X93 / X94	EtherCAT	2x RJ 45	
Memory Card (safety program)			
	MC	1x Mini SD (front side)	
Status LEDs	3		

SDU-11-PXV

SCU_{SERIES} » SCU Slaves

ENCODER INTERFACE

Pin assignment ENC 1.5

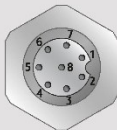
Pin	RS 485	Front side SDU
1	Enable Blue	 ENC 1.5
2	UB+	
3	Data +	
4	Data -	
5	Sync IN	
6	Enable Red	
7	GND	
8	NC	

ENCODERSPECIFICATIONS

PXV100AS-F200-R4-V19-BBH

Physical Layer	RS-485 compatible
Data format	Binary Code
Transmission rate	115200 Bit/s
Type of connection (ENC 1.5)	male connector 1x M12, 8-pin
Termination	120 Ω , selectable
General data	
Overrun speed v	≤ 10 m/s
Measuring length	max. 100000 m
Resolution	± 1 mm
Measuring frequency	100 Hz

Appendix: data sheets SCU Slaves

SDU-11-PXV

SCU_{SERIES} » SCU Slaves



ORDER INFORMATION

FSoE SLAVES

item	description	item no.
SDU-11-PXV	Decentralized axis expansion module for one axis, with 1 safePXV encoder interface	2472

ACCESSORIES

item	description	item no.
SMX91	Programming adapter	1010
SXxxx-x	Terminal connector, screw terminals (set), encoded for cabling SDU-11	on request
SXxxx-x	Terminal connector, spring terminals (set), encoded for cabling SDU-11	on request
PXV100AS-F200-R4-V19-BBH	Optical reading head for incident light positioning system	2581

SOFTWARE

item	description	item no.
SafePLC ² 1st	Programming software, 1te License incl. Hardlock	1244
SafePLC ² 2nd	Programming software, 2te License incl. Hardlock	1646
SafePLC ² 3rd	Programming software, 3te License incl. Hardlock	1647

SDU-12

SCU_{SERIES} » SCU Slaves

BBH
PRODUCTS



DESCRIPTION

FSoE slave module for safe speed and position of 1 axis for further evaluation in an FSoE master module

- 14 Safe digital inputs
- Up to 4 safe digital outputs
- 5 Encoder interfaces
- 2 Relay / pulse outputs
- 2 Auxiliary outputs
- Safety controller up to PL e acc. to EN ISO 13849-1 or SIL3 acc. to IEC 61508

CHARACTERISTIC OF THE MODULE

- » Decentralized safe axle assembly for the EtherCAT environment
- » Safe detection of speed and position of one axis
- » Fast response time with integrated Fast Channel Task with guaranteed processing time of 2 ms
- » Complete speed and position-related safety functions for drive monitoring IEC 61800-5-2 integrated into firmware
- » Speed monitoring
- » RPM-monitoring
- » Standstill monitoring
- » Sense of rotation monitoring
- » Safe incremental dimension
- » Emergency Stop monitoring
- » Position monitoring
- » Position range monitoring
- » Trend range monitoring
- » Target position monitoring
- » Pulse outputs for cross-shortening detection of digital input signals
- » Monitored relay outputs for safety-relevant functions
- » Switchable safe semi-conductor outputs pn-, pp-switching for safety-relevant functions
- » Functionplan-oriented parametrization
- » Parameter management for expansion modules in base device
- » Comprehensive diagnostics functions integrated
- » Coded status display via front-side 7 segment display and status LEDs
- » Allows the connection of 2 rotary encoders per axis (SSI, SinCos, TTL, Proxy)
- » 2nd encoder interface also supports HTL (200 kHz), SinCos High-Resolution and Resolver

Appendix: data sheets SCU Slaves

SDU-12
SCU_{SERIES} » SCU Slaves

BBH
PRODUCTS

SAFETY RELATED CHARACTERISTIC DATA

Performance Level	PL e (EN ISO 13849-1)
PFH / architecture	2,0* 10 ⁻⁹ / Cat. 4
Safety Integrity Level	SIL 3 (IEC 61508)
Proof test interval	20 years = max. operating period

GENERAL DATA

Max. no. of expansion modules	–
Interface for expansion modules	RJ-45 (Ethernet)
Number of safe digital inputs	14
Number of safe digital outputs	
	pp-switching * 4
	pn-switching * 2
Number of safe digital I/O	–
Number of relay outputs	2
Number of safe analogue inputs	–
Number of auxiliary outputs	2
Number of pulse outputs (clock outputs)	2
Type of connection	Plug-in terminals with spring or screw connection
Axis monitoring	1
Encoder interfaces (D-Sub / screw terminals)	2 / 3 **
Encoder technology (See Encoder specifications)	D-SUB Enc 1.1: SSI-Absolut, SinCos, Incremental-TTL D-SUB Enc 1.2: SSI-Absolut, SinCos (HighRes), Incremental-TTL, Resolver Terminal X23: HTL proximity sensor (10 kHz), Terminals X27 , X28: Incremental-HTL (200 kHz)
Ccycle time PLC	8 ms
Fast Channel	2 ms
Safe Slave	FSoE

* pn/pp are configurable via SafePLC²

** maximum 2 encoder / axis

Appendix: data sheets SCU Slaves

SDU-12
SCUSERIES » SCU Slaves

BBH
PRODUCTS

ELECTRICAL DATA

Supply voltage (tolerance)		24 VDC; 2A (-10%, +20%)
Fuse	X11.1 / 24+	min. 30 VDC; max. 3,15A
	X11.2 / AQ1+	min. 30 VDC; max. 10A
Max. Power consumption (logic)	SDU-12	5,2 W
Rated data digital inputs		24 VDC; 20 mA Typ1 acc. to IEC 61131-2
Rated data digital outputs		
	pn-switching	24 VDC; 2A
	pp-switching	24 VDC; 2A
	auxiliary outputs	24 VDC; 250mA
	pulse outputs (clock outputs)	24 VDC; 250mA
Rated data relays		
Normally open	DC 13	24 VDC; 2A
	AC 15	230 VAC; 2A

DERATING OUTPUTS

- » Maximum current load based on temperature.
- » The maximum total current is 10A.

type of module	outputs	temperature 30°C / 50°C
SDU-12	QX 00 – QX 03	2A / 1,8A

2A outputs can be fully loaded at an ambient temperature of up to **30°C**.
From a ambient temperature from **30°C** to maximum **50°C**, the 2A outputs
 can be loaded to a maximum of **1.8A**.

The maximum total current is **10A**. (IO-Board)

Appendix: data sheets SCU Slaves

SDU-12 SCU_{SERIES} » SCU Slaves



ENVIRONMENTAL DATA

Temperature	0°C ... +50°C operation
	-25°C ... +70°C storage and transport
Class of protection	IP 20
Climatic category	3K3 acc. to DIN EN 60721-3
Min-, Maximum relative humidity (no condensation)	5% - 85%
EMC	DIN EN 61000-6-2, DIN EN 61000-6-4, DIN EN 61000-6-7, DIN EN 61800-3, DIN EN 61326-3, DIN EN 62061
Operating altitude	2000m

MECHANICAL DATA

Dimension (HxDxW [mm])	SDU-12	100x115x90
Weight [g]	SDU-12	410
Mounting		to snap on top-hat rail
Min. terminal cross-section / AWG		0,2 mm ² / 24
Max. terminal cross-section / AWG		2,5 mm ² / 12

Appendix: data sheets SCU Slaves

SDU-12 SCU_{SERIE} » SCU Slaves



DEVICE INTERFACES

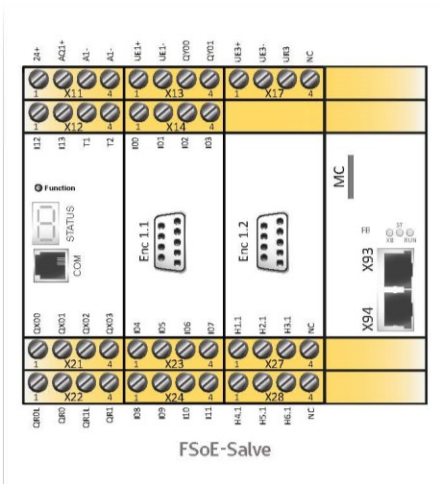

Interface	Description of interface
X11 – X14 / X17 – X24	Voltage supply and I/O interface
COM	Diagnostic- and configuration interface
MC	Memory card for safety program
X93 - ECAT IN / X94 - ECAT OUT	Fieldbus interfaces
X23 / X27 – X28	Encoder interfaces
Enc 1.1 / Enc 1.2	Encoder interfaces

VOLTAGE SUPPLY AND I/O INTERACE

X11		
Pin	1 - 24+	Voltage supply device +24 VDC
	2 - AQ1+	Voltage supply device +24 VDC outputs
	3 - A1-	Voltage supply device 0 VDC
	4 - A1-	
X12		
Pin	1 - I12	Safe digital inputs
	2 - I13	
	3 - T1	Clock outputs
	4 - T2	
X21		
Pin	1 - QX00	Safe output pn-/ pp-switching 00
	2 - QX01	Safe output pn-/ pp-switching 01
	3 - QX02	Safe output pn-/ pp-switching 02
	4 - QX03	Safe output pn-/ pp-switching 03
X22		
Pin	1 - QR0L	Safe relay input
	2 - QR0	Safe relay output
	3 - QR1L	Safe relay input
	4 - QR1	Safe relay output

X13		
Pin	1 - UE1+	Voltage supply +24 VDC encoder
	2 - UE1-	
	3 - QY00	Auxiliary outputs
	4 - QY01	
X14		
Pin	1 - I00	Safe digital inputs
	2 - I01	
	3 - I02	
	4 - I03	
X23		
Pin	1 - I04	Safe digital inputs
	2 - I05	
	3 - I06	
	4 - I07	
X24		
Pin	1 - I08	Safe digital inputs
	2 - I09	
	3 - I10	
	4 - I11	
X17		
Pin	1 - UE3+	Voltage supply +24 VDC encoder
	2 - UE3-	
	3 - UR3	Voltage supply 0 V
	4 - NC	No function

Appendix: data sheets SCU Slaves

SDU-12

SCU_{SERIES} » SCU Slaves

BBH
PRODUCTS

DIAGNOSTIC AND CONFIGURATION INTERFACE

Pin assignment

RJ 10, 4-pin		
Pin	Description	COM front side
1	GND	
2	RS485-	
3	RS485+	
4	VCCH	

» With existing Ethernet-based fieldbus interface, it can be used as a diagnostic and configuration interface.

FIELDBUS INTERFACES

Pin assignment, ethernet-based interface

EtherCAT interface (RJ45)				
Pin	Name	Description	Colour	X93 / X94
1	TX +	Transmit Data +	white-orange	
2	TX -	Transmit Data -	orange	
3	RX +	Receive Data +	white-green	
4	nc	Not used	blue	
5	nc	Not used	white-blue	
6	RX -	Receive Data -	green	
7	nc	Not used	white-brown	
8	nc	Not used	brown	

INTEGRATED COMMUNICATION INTERFACE

» The integrated communication interface of the FSoE slave includes a safe EtherCAT interface for decentralized communication with an FSoE-Master unit.

General data

Fieldbus interface			
X93 / X94	EtherCAT	2x RJ 45	
Memory Card (safety program)			
	MC	1x Mini SD (front side)	
Status LED's		3	

Appendix: data sheets SCU Slaves

SDU-12 SCU_{SERIES} » SCU Slaves



ENCODER INTERFACES

Pin assignment Enc 1.1 , Enc 1.2

Pin	Enc 1.1 Inc / Sin/Cos / SSI	Enc 1.2 Inc / Sin/Cos / SSI	Enc 1.2 Resolver	Front side SDU
1	n.c.	n.c.	Ref_Out +	
2	GND_ENC	GND_ENC	GND_ENC	
3	n.c.	n.c. / n.c. / Clk +	Ref_In +	
4	B - / COS - / Clk -	B - / COS - / n.c.	COS -	
5	A + / SIN + / Data +	A + / SIN + / Data +	SIN +	
6	A - / SIN - / Data -	A - / SIN - / Data -	SIN -	
7	n.c.	n.c. / n.c. / Clk -	Ref -	
8	B + / COS + / Clk +	B + / COS + / n.c.	COS +	
9	U_ENC	U_ENC	U_ENC	

Pin assignment X23 , X27 , X28

Pin	Z1 - Z1 / Z2 - Z2	Terminals
1	A (\bar{A}) / A (\bar{A})	
2	-- / B (\bar{B})	
3	A (\bar{A}) / A (\bar{A})	
4	-- / B (\bar{B})	

Pin	A+/A-	A+ Signal	
1 - H1.1	A +	24V	
2 - H2.1	A -	A	
3 - H3.1	A +	GND	
4 - NC	—	—	
Pin	B+/B-	B+ Signal	
1 - H4.1	B +	24V	
2 - H5.1	B -	B	
3 - H6.1	B +	GND	
4 - NC	—	—	

ENCODERSPECIFICATIONS

Incremental - TTL	
Physical Layer	RS-422 compatible
Measuring signal A/B	Track with 90 degree phase difference
Type of connection	D-SUB 9pole
Max. frequency of input cycles (Enc 1.1 / Enc 1.2)	200 kHz / 250 kHz
Sin/Cos	
Physical Layer	RS-422 compatible
Measuring signal A/B	Track with 90 degree phase difference
Type of connection	D-SUB 9pole
Standard Mode	
Max. frequency of input clock pulses (Enc 1.1 / Enc 1.2)	200 kHz / 250 kHz
High Resolution Mode	
Max. frequency of input clock pulses (Enc 1.2)	15 kHz

Appendix: data sheets SCU Slaves

SDU-12
SCU_{SERIES} » SCU Slaves

BBH
PRODUCTS

SSI-Absolut

Data interface	Serial S ynchronous Interface (SSI) with variable data length of 12 – 28 Bit
Data format	Binary, Gray code
Physical Layer	RS-422 compatible
Type of connection	D-SUB 9pole
Mode	Listener
SSI-Listener Mode	
Clock rate (Enc 1.1 / Enc 1.2)	100 kHz ... 250 kHz / 100 kHz ... 350 kHz
Min. clock pause time	150 µsec
Max. clock pause time	1 msec

Resolver

Measuring signal	Sin/Cos – track with 90 degree phase difference
Signal frequency	max. 600 Hz (900 Hz Deep pass)
Input voltage	max. 8 V _{ss} (at 4,7 kΩ)
Resolution	9 Bit / pole
Supported pole number	2 - 16
Type of connection (Enc 1.2)	D-SUB 9-pole
Mode	Listener
Resolver-Listener operation	
Reference frequency	4 kHz – 16 kHz
Reference amplitude	8 V _{ss} – 28 V _{ss}
Reference signal form	Sinusoidal, triangle, rectangle
Transformation ratio	2:1; 3:2; 4:1
Phase fault	max. 8°

Incremental - HTL

Signal level	24V / 0V
Physical Layer	PUSH / PULL
Max. counting pulse frequency	200 kHz
Type of connection (X27 / X28)	Plug-in terminals with spring or screw connection

HTL proximity sensor

Signal level	24V / 0V
Max. counting pulse frequency (circuit logic de-bounced)	10 kHz
Pulse width	50 µsec
Type of connection (X23)	Plug-in terminals with spring or screw connection

HTL proximity switch - extended monitoring

Signal level	24V / 0V
Max. counting frequency (circuit logic de-bounced)	4 kHz
Physical Layer	PUSH / PULL
Measuring signal A/B	Track with 90 degree phase difference
Type of connection (X23)	Plug-in terminals with spring or screw connection

Appendix: data sheets SCU Slaves

SDU-12

SCU_{SERIES} » SCU Slaves



ORDER INFORMATION

FSoE SLAVES

item	description	item no.
SDU-12	Decentralized axis expansion module for one axis	2395

ACCESSORIES

item	description	item no.
SMX91	Programming cable SCU	1010
SXxxx-x	Terminal connector, screw terminals (set), encoded for cabling SDU-12	on request
SXxxx-x	Terminal connector, spring terminals (set), encoded for cabling SDU-12	on request

SOFTWARE

item	description	item no.
SafePLC ² 1st	Programming software, 1te License incl. Hardlock	1244
SafePLC ² 2nd	Programming software, 2te License incl. Hardlock	1646
SafePLC ² 3rd	Programming software, 3te License incl. Hardlock	1647

SDU-21

SCUSERIES » SCU Slaves

BBH
PRODUCTS



DESCRIPTION

FSoE slave module for safe speed and Position of up to 2 axes for further evaluation in an FSoE master module

- 14 Safe digital inputs
- Up to 4 safe digital outputs
- 4 Encoder interfaces
- 2 Relay / pulse outputs
- 2 Auxiliary outputs
- Safety controller up to PL e acc. to EN ISO 13849-1 or SIL3 acc. to IEC 61508

CHARACTERISTIC OF THE MODULE

- » Decentralized safe axle assembly for the EtherCAT environment
- » Safe detection of speed and position of up to two axes
- » Fast response time with integrated Fast Channel Task with guaranteed processing time of 2 ms
- » Complete speed and position-related safety functions for drive monitoring IEC 61800-5-2 integrated into firmware
- » Speed monitoring
- » RPM-monitoring
- » Standstill monitoring
- » Sense of rotation monitoring
- » Safe incremental dimension
- » Emergency Stop monitoring
- » Position monitoring
- » Position range monitoring
- » Trend range monitoring
- » Target position monitoring
- » Pulse outputs for cross-shorting detection of digital input signals
- » External contact monitoring of connected switchgear (EMU)
- » Monitored relay outputs for safety-relevant functions
- » Switchable safe semi-conductor outputs pn-, pp-switching for safety-relevant functions
- » Functionplan-oriented parametrization
- » Parameter management for expansion modules in base device
- » Comprehensive diagnostics functions integrated
- » Coded status display via front-side 7 segment display and status LEDs

Appendix: data sheets SCU Slaves

SDU-21
SCU_{SERIES} » SCU Slaves

BBH
PRODUCTS

SAFETY RELATED CHARACTERISTIC DATA

Performance Level	PL e (EN ISO 13849-1)
PFH / architecture	2,0* 10 ⁻⁹ / Cat. 4
Safety Integrity Level	SIL 3 (IEC 61508)
Proof test interval	20 years = max. operating period

GENERAL DATA

Max. no. of expansion modules	–
Interface for expansion modules	RJ-45 (Ethernet)
Number of safe digital inputs	14
Number of safe digital outputs	
	pp-switching * 4
	pn-switching * 2
Number of safe digital I/O	–
Number of relay outputs	2
Number of safe analogue inputs	–
Number of auxiliary outputs	2
Number of pulse outputs (clock outputs)	2
Type of connection	Plug-in terminals with spring or screw connection
Axis monitoring	2
Encoder interfaces (D-Sub / screw terminals)	2 / 2 **
Encoder technology (See Encoder specifications)	D-SUB Enc 1.1: SSI-Absolut, SinCos, Incremental-TTL D-SUB Enc 1.2: SSI-Absolut, SinCos, Incremental-TTL Terminal X23: HTL proximity sensor (10kHz)
Cycle time PLC	8 ms
Fast Channel	2 ms
Safe Slave	FSoE

* pn/pp are configurable via SafePLC²

** maximum 2 encoder / axis

Appendix: data sheets SCU Slaves

SDU-21

SCU_{SERIES} » SCU Slaves

BBH
PRODUCTS

ELECTRICAL DATA

Supply voltage (tolerance)		24 VDC; 2A (-10%, +20%)	
Fuse	X11.1 / 24+	min. 30 VDC; max. 3,15A	
	X11.2 / AQ1+	min. 30 VDC; max. 10A	
Max. Power consumption (logic)	SDU-21	4,7 W	
Rated data digital inputs		24 VDC; 20 mA Typ1 acc. to IEC 61131-2	
Rated data digital outputs			
	pn-switching	24 VDC; 2A	
	pp-switching	24 VDC; 2A	
	auxiliary outputs	24 VDC; 250mA	
	pulse outputs (clock outputs)	24 VDC; 250mA	
Rated data relays			
	Normally open	DC 13	24 VDC; 2A
		AC 15	230 VAC; 2A

DERATING OUTPUTS

- » Maximum current load based on temperature.
- » The maximum total current is 10A.

type of module	outputs	temperature 30°C / 50°C
SDU-21	QX 00 – QX 03	2A / 1,8A

*2A outputs can be fully loaded at an ambient temperature of up to **30°C**. From a ambient temperature from **30°C** to maximum **50°C**, the 2A outputs can be loaded to a maximum of **1.8A**.*

*The maximum total current is **10A**. (IO-Board)*

Appendix: data sheets SCU Slaves

SDU-21 SCU_{SERIES} » SCU Slaves



ENVIRONMENTAL DATA

Temperature	0°C ... +50°C operation
	-25°C ... +70°C storage and transport
Class of protection	IP 20
Climatic category	3K3 acc. to DIN EN 60721-3
Min-, Maximum relative humidity (no condensation)	5% - 85%
EMC	DIN EN 61000-6-2, DIN EN 61000-6-4, DIN EN 61000-6-7, DIN EN 61800-3, DIN EN 61326-3, DIN EN 62061
Operating altitude	2000m

MECHANICAL DATA

Dimension (HxDxW [mm])	SDU-21	100x115x90
Weight [g]	SDU-21	410
Mounting		to snap on top-hat rail
Min. terminal cross-section / AWG		0,2 mm ² / 24
Max. terminal cross-section / AWG		2,5 mm ² / 12

Appendix: data sheets SCU Slaves

SDU-21 SCU SERIES » SCU Slaves



DEVICE INTERFACES

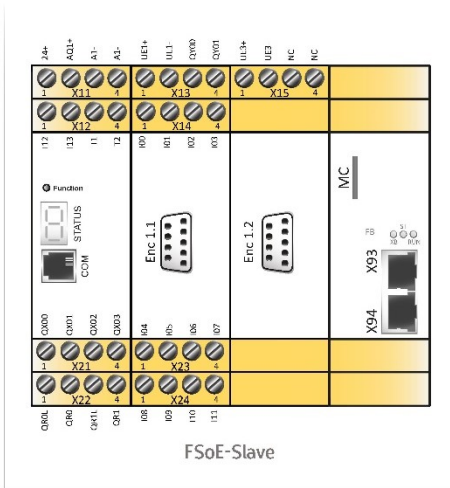

Interface	Description of interface
X11 – X14 / X15 – X24	Voltage supply and I/O interface
COM	Diagnostic- and configuration interface
X93 - ECAT IN / X94 - ECAT OUT	Fieldbus interfaces
Enc 1.1 / Enc 1.2	Encoder interfaces
X23	Encoder interfaces

VOLTAGE SUPPLY AND I/O INTERACE

X11			
Pin	1 - 24+	Voltage supply device +24 VDC	
	2 - AQ1+	Voltage supply device +24 VDC outputs	
	3 - A1- 4 - A1-	Voltage supply device 0 VDC	
X12			
Pin	1 - I12 2 - I13	Safe digital inputs	
	3 - T1 4 - T2	Clock outputs	
	X21		
	Pin	1 - QX00	Safe output pn-/ pp-switching 00
2 - QX01		Safe output pn-/ pp-switching 01	
3 - QX02		Safe output pn-/ pp-switching 02	
4 - QX03		Safe output pn-/ pp-switching 03	
X22			
Pin	1 - QR1L	Safe relay input	
	2 - QR1	Safe relay output	
	3 - QR2L	Safe relay input	
	4 - QR2	Safe relay output	

X13			
Pin	1 - UE1+ 2 - UE1-	Voltage supply +24 VDC encoder	
	3 - QY00 4 - QY01	Auxiliary outputs	
	X14		
	Pin	1 - I00 2 - I01 3 - I02 4 - I03	Safe digital inputs
X23			
Pin		1 - I04 2 - I05 3 - I06 4 - I07	Safe digital inputs
		X24	
	Pin	1 - I08 2 - I09 3 - I10 4 - I11	Safe digital inputs
		X15	
Pin		1 - UE3+ 2 - UE3-	Voltage supply +24 VDC encoder
		3 - UR3	Voltage supply 0 V
	4 - NC	No function	

Appendix: data sheets SCU Slaves

SDU-21

SCU_{SERIES} » SCU Slaves



DIAGNOSTIC AND CONFIGURATION INTERFACE

Pin assignment

RJ 10, 4-pin		
Pin	Description	COM front side
1	GND	
2	RS485-	
3	RS485+	
4	VCCH	

» With existing Ethernet-based fieldbus interface, it can be used as a diagnostic and configuration interface.

FIELDBUS INTERFACES

Pin assignment, ethernet-based interface

Safe EtherCAT interface (RJ45)				
Pin	Name	Description	Colour	X93 / X94
1	TX+	Transmit Data +	white-orange	
2	TX-	Transmit Data -	orange	
3	RX+	Receive Data +	white-green	
4	nc	Not used	blue	
5	nc	Not used	white-blue	
6	RX-	Receive Data -	green	
7	nc	Not used	white-brown	
8	nc	Not used	brown	

INTEGRATED COMMUNICATION INTERFACE

» The integrated communication interface of the FSoE slave includes a safe EtherCAT interface for decentralised communication with an FSoE-Master unit.

General data			
Fieldbus interface			
X93 / X94	EtherCAT	2x RJ 45 *	
Memory Card (safety program)			
MC	1x Mini SD (front side)		
Status LED's	3		

Appendix: data sheets SCU Slaves

SDU-21 SCU_{SERIES} » SCU Slaves



ENCODER INTERFACES

Pin assignment Enc 1.1 , Enc 1.2

Pin	Enc 1.1 / Enc 1.2 Inc / Sin/Cos / SSI	Front side SDU
1	n.c.	
2	GND	
3	n.c.	
4	B / COS - / Clk -	
5	A + / SIN + / Data +	
6	A - / SIN - / Data -	
7	n.c.	
8	B + / COS + / Clk +	
9	VCC +	

Pin assignment X23

Pin	Z1 - Z1 / Z2 - Z2	Terminal
1	A (\bar{A}) / A (\bar{A})	
2	-- / B (\bar{B})	
3	A (\bar{A}) / A (\bar{A})	
4	-- / B (\bar{B})	

ENCODER SPECIFICATIONS

Incremental - TTL	
Physical Layer	RS-422 compatible
Measuring signal A/B	Track with 90 degree phase difference
Type of connection	D-SUB 9pole
Max. frequency of input cycles (Enc 1.1 / Enc 1.2)	200 kHz
Sin/Cos	
Physical Layer	RS-422 compatible
Measuring signal A/B	Track with 90 degree phase difference
Type of connection	D-SUB 9pole
Standard Mode	
Max. frequency of input clock pulses (Enc 1.1, Enc 1.2)	200 kHz
SSI-Absolut	
Data interface	Serial Synchronous Interface (SSI) with variable data length of 12 – 28 Bit
Data format	Binary, Gray code
Physical Layer	RS-422 compatible
Type of connection	D-SUB 9pole
Mode	Listener
SSI-Listener Mode	
Clock rate (Enc 1.1, Enc 1.2)	100 kHz ... 250 kHz
Min. clock pause time	150 µsec
Max. clock pause time	1 msec

SDU-21

SCU_{SERIES} » SCU Slaves



ENCODER SPECIFICATIONS

HTL proximity sensor

Signal level	24V / 0V
Max. counting pulse frequency (circuit logic de-bounced)	10 kHz
Pulse width	50 µsec
Type of connection (X23)	Plug-in terminals with spring or screw connection

HTL proximity switch - extended monitoring

Signal level	24V / 0V
Max. counting frequency (circuit logic de-bounced)	4 kHz
Physical Layer	PUSH / PULL
Measuring signal A/B	Track with 90 degree phase difference
Type of connection (X23)	Plug-in terminals with spring or screw connection

Appendix: data sheets SCU Slaves

SDU-21

SCU_{SERIES} » SCU Slaves



ORDER INFORMATION

FSoE SLAVES

item	description	item no.
SDU-21	Decentralized axis expansion module for 2 axes	2396

ACCESSORIES

item	description	item no.
SMX91	Programming adapter	1010
SXxxx-x	Terminal connector, screw terminals (set), encoded for cabling SDU-21	on request
SXxxx-x	Terminal connector, spring terminals (set), encoded for cabling SDU-21	on request

SOFTWARE

item	description	item no.
SafePLC ² 1st	Programming software, 1te License incl. Hardlock	1244
SafePLC ² 2nd	Programming software, 2te License incl. Hardlock	1646
SafePLC ² 3rd	Programming software, 3te License incl. Hardlock	1647

SDU-21A

SCUSERIES » SCU Slaves

BBH
PRODUCTS



DESCRIPTION

FSoE slave module for safe speed and Position of up to 2 axes for further evaluation in an FSoE master module

- 14 Safe digital inputs
- Up to 4 safe digital outputs
- 4 Encoder interfaces
- 2 Analog inputs
- 2 Relay / pulse outputs
- 2 Auxiliary outputs
- Safety controller up to PL e acc. to EN ISO 13849-1 or SIL3 acc. to IEC 61508

CHARACTERISTIC OF THE MODULE

- » Decentralized safe axle assembly for the EtherCAT environment
- » Safe detection of speed and position from up to two axes
- » Fast response time with integrated Fast Channel Task with guaranteed processing time of 2 ms
- » Complete speed and position-related safety functions for drive monitoring IEC 61800-5-2 integrated into firmware
- » Speed monitoring
- » RPM-monitoring
- » Standstill monitoring
- » Sense of rotation monitoring
- » Safe incremental dimension
- » Emergency Stop monitoring
- » Position monitoring
- » Position range monitoring
- » Trend range monitoring
- » Target position monitoring
- » Pulse outputs for cross-shortening detection of digital input signals
- » External contact monitoring of connected switchgear (EMU)
- » Monitored relay outputs for safety-relevant functions
- » Switchable safe semi-conductor outputs pn-, pp-switching for safety-relevant functions
- » Functionplan-oriented parametrization
- » Parameter management for expansion modules in base device
- » Comprehensive diagnostics functions integrated
- » Coded status display via front-side 7 segment display and status LEDs

Appendix: data sheets SCU Slaves

SDU-21A SCU_{SERIES} » SCU Slaves



SAFETY RELATED CHARACTERISTIC DATA

Performance Level	PL e (EN ISO 13849-1)
PFH / Architektur	2,0* 10 ⁻⁹ / Cat. 4
Safety Integrity Level	SIL 3 (IEC 61508)
Proof test interval	20 years = max. operating period

GENERAL DATA

Max. no. of expansion modules	–
Interface for expansion modules	RJ-45 (Ethernet)
Number of safe digital inputs	14
Number of safe digital outputs	
	pp-switching * 4
	pn-switching * 2
Number of safe digital I/O	–
Number of relay outputs	2
Number of safe analogue inputs	2 ***
Number of auxiliary outputs	2
Number of pulse outputs (clock outputs)	2
Type of connection	Plug-in terminals with spring or screw connection
Axis monitoring	2
Encoder interfaces (D-Sub / screw terminals)	2 / 2 **
Encoder technology (See Encoder specifications)	D-SUB Enc 1.1: SSI-Absolut, SinCos, Incremental-TTL D-SUB Enc 1.2: SSI-Absolut, SinCos, Incremental-TTL Terminal X23: HTL proximity sensor (10kHz)
Cycle time PLC	8 ms
Fast Channel	2 ms
Safe Slave	FSOE

* pn/pp are configurable via SafePLC²

** maximum 2 encoder / axis

*** Analogue electricity, voltage inputs are available as options

SDU-21A-U Voltage inputs
 SDU-21A-I Current inputs
 SDU-21A Voltage and current inputs

Appendix: data sheets SCU Slaves

SDU-21A

SCU_{SERIES} » SCU Slaves



ELECTRICAL DATA

Supply voltage (tolerance)		24 VDC; 2A (-10%, +20%)
Fuse	X11.1 / 24+	min. 30 VDC; max. 3,15A
	X11.2 / AQ1+	min. 30 VDC; max. 10A
Max. Power consumption (logic)		
	SDU-21A	4,7 W
Rated data digital inputs		24 VDC; 20 mA Typ1 acc. to IEC 61131-2
Rated data digital outputs		
	pn-switching	24 VDC; 2A
	pp-switching	24 VDC; 2A
	auxiliary outputs	24 VDC; 250mA
	pulse outputs (clock outputs)	24 VDC; 250mA
Rated data relays		
	Normally open	
	DC 13	24 VDC; 2A
	AC 15	230 VAC; 2A
Rated data analogue inputs		
	SDU-21A	-7 ... +10 V 4 ... 20 mA

DERATING OUTPUTS

- » Maximum current load based on temperature.
- » The maximum total current is 10A.

type of module	outputs	temperature 30°C / 50°C
SDU-21A	QX 00 – QX 03	2A / 1,8A

2A outputs can be fully loaded at an ambient temperature of up to **30°C**.
From a ambient temperature from **30°C** to maximum **50°C**, the 2A outputs
can be loaded to a maximum of **1.8A**.

The maximum total current is **10A**. (IO-Board)

Appendix: data sheets SCU Slaves

SDU-21A

SCU_{SERIES} » SCU Slaves



ENVIRONMENTAL DATA

Temperature	0°C ... +50°C operation
	-25°C ... +70°C storage and transport
Class of protection	IP 20
Climatic category	3K3 acc. to DIN EN 60721-3
Min-, Maximum relative humidity (no condensation)	5% - 85%
EMC	DIN EN 61000-6-2, DIN EN 61000-6-4, DIN EN 61000-6-7, DIN EN 61800-3, DIN EN 61326-3, DIN EN 62061
Operating altitude	2000m

MECHANICAL DATA

Dimension (HxDxW [mm])	SDU-21A	100x115x90
Weight [g]	SDU-21A	410
Mounting		to snap on top-hat rail
Min. terminal cross-section / AWG		0,2 mm ² / 24
Max. terminal cross-section / AWG		2,5 mm ² / 12

Appendix: data sheets SCU Slaves

SDU-21A SCU SERIES » SCU Slaves



DEVICE INTERFACES

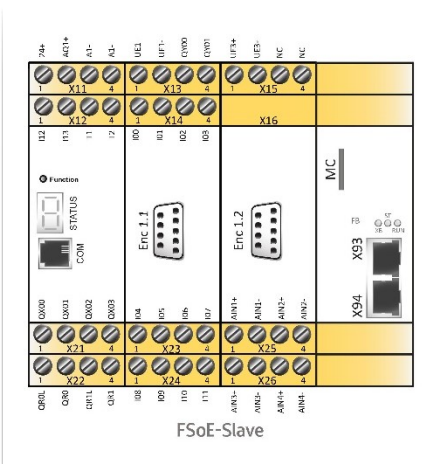

Interface	Description of interface
X11 – X14 / X15 – X26	Voltage supply and I/O interface
COM	Diagnostic- and configuration interface
X93 - ECAT IN / X94 - ECAT OUT	Fieldbus interfaces
Enc 1.1 / Enc 1.2	Encoder interfaces
X23	Encoder interfaces

VOLTAGE SUPPLY AND I/O INTERACE

X11			
Pin	1 - 24+	Voltage supply device +24 VDC	
	2 - AQ1+	Voltage supply device +24 VDC outputs	
	3 - A1- 4 - A1-	Voltage supply device 0 VDC	
X12			
Pin	1 - I12 2 - I13	Safe digital inputs	
	3 - T1 4 - T2	Clock outputs	
	X21		
	Pin	1 - QX00	Safe output pn-/ pp-switching 00
2 - QX01		Safe output pn-/ pp-switching 01	
3 - QX02		Safe output pn-/ pp-switching 02	
4 - QX03		Safe output pn-/ pp-switching 03	
X22			
Pin	1 - QR0L	Safe relay input	
	2 - QR0	Safe relay output	
	3 - QR1L	Safe relay input	
	4 - QR1	Safe relay output	

X13			
Pin	1 - UE1+ 2 - UE1-	Voltage supply +24 VDC encoder	
	3 - QY00 4 - QY01	Auxiliary outputs	
	X14		
	Pin	1 - I00 2 - I01 3 - I02 4 - I03	Safe digital inputs
X23			
Pin		1 - I04 2 - I05 3 - I06 4 - I07	Safe digital inputs
		X24	
	Pin	1 - I08 2 - I09 3 - I10 4 - I11	Safe digital inputs
		X15	
Pin		1 - UE3+ 2 - UE3-	Voltage supply +24 VDC encoder
		3 - UR3	Voltage supply 0 V
	4 - NC	No function	

Appendix: data sheets SCU Slaves

SDU-21A

SCU_{SERIES} » SCU Slaves



X25 (voltage inputs)

Pin	Description	Notes
1	AIN 1+	Safe analog input
2	AIN 1-	
3	AIN 2+	Safe analog input
4	AIN 2-	

X26 (current inputs)

Pin	Description	Notes
1	AIN 3+	Safe analog input
2	AIN 3-	
3	AIN 4+	Safe analog input
4	AIN 4-	

DIAGNOSTIC AND CONFIGURATION INTERFACE

Pin assignment

RJ 10, 4-pin		
Pin	Description	COM Front side
1	GND	
2	RS485-	
3	RS485+	
4	VCCH	

» With existing Ethernet-based fieldbus interface, it can be used as a diagnostic and configuration interface.

Appendix: data sheets SCU Slaves

SDU-21A SCU_{SERIES} » SCU Slaves



FIELDBUS INTERFACES

Pin assignment female connector

EtherCAT interface (RJ45)				
Pin	Name	Description	Colour	X93 / X94
1	TX+	Transmit Data +	white-orange	
2	TX-	Transmit Data -	orange	
3	RX+	Receive Data +	white-green	
4	nc	Not used	blue	
5	nc	Not used	white-blue	
6	RX-	Receive Data -	green	
7	nc	Not used	white-brown	
8	nc	Not used	brown	

INTEGRATED COMMUNICATION INTERFACE

» The integrated communication interface of the FSoE slave includes a safe EtherCAT interface for decentralised communication with an FSoE-Master unit.

General data			
Fieldbus interface			
X93 / X94	EtherCAT	2x RJ 45	
Memory Card (safety program)			
	MC	1x Mini SD (front side)	
Status LED`s		3	

Appendix: data sheets SCU Slaves

SDU-21A SCUSERIES » SCU Slaves



ENCODER INTERFACES

Pin assignment Enc 1.1 , Enc 1.2

Pin	Enc 1.1 / Enc 1.2 Inc / Sin/Cos / SSI	Front side SDU
1	n.c.	
2	GND	
3	n.c.	
4	B / COS - / Clk -	
5	A + / SIN + / Data +	
6	A - / SIN - / Data -	
7	n.c.	
8	B + / COS + / Clk +	
9	VCC +	

Pin assignment X23

Pin	Z1 - Z1 / Z2 - Z2	Terminal
1	A (\bar{A}) / A (\bar{A})	
2	-- / B (\bar{B})	
3	A (\bar{A}) / A (\bar{A})	
4	-- / B (\bar{B})	

ENCODERSPECIFICATIONS

Incremental - TTL	
Physical Layer	RS-422 compatible
Measuring signal A/B	Track with 90 degree phase difference
Type of connection	D-SUB 9-pole
Max. frequency of input cycles (Enc 1.1 / Enc 1.2)	200 kHz
Sin/Cos	
Physical Layer	RS-422 compatible
Measuring signal A/B	Track with 90 degree phase difference
Type of connection	D-SUB 9-pole
Standard Mode	
Max. frequency of input clock pulses (Enc 1.1, Enc 1.2)	200 kHz
SSI-Absolut	
Data interface	Serial Synchronous Interface (SSI) with variable data length of 12 – 28 Bit
Data format	Binary, Gray code
Physical Layer	RS-422 compatible
Type of connection	D-SUB 9-pole
Mode	Listener
SSI-Listener Mode	
Clock rate (Enc 1.1, Enc 1.2)	100 kHz ... 250 kHz
Min. clock pause time	150 µsec
Max. clock pause time	1 msec

SDU-21A

SCU_{SERIES} » SCU Slaves



ENCODER SPECIFICATIONS

HTL proximity sensor

Signal level	24V / 0V
Max. counting pulse frequency (circuit logic de-bounced)	10 kHz
Pulse width	50 µsec
Type of connection (X23)	Plug-in terminals with spring or screw connection

HTL proximity switch - extended monitoring

Signal level	24V / 0V
Max. counting frequency (circuit logic de-bounced)	4 kHz
Physical Layer	PUSH / PULL
Measuring signal A/B	Track with 90 degree phase difference
Type of connection (X23)	Plug-in terminals with spring or screw connection

Appendix: data sheets SCU Slaves

SDU-21A

SCU_{SERIES} » SCU Slaves



ORDER INFORMATION

FSoE SLAVES

item	description	item no.
SDU-21A	Decentralized axis expansion module for 2 axes with Analog option (voltage + current inputs)	2398
SDU-21A-I	Decentralized axis expansion module for 2 axes with Analog option (current inputs)	2399
SDU-21A-U	Decentralized axis expansion module for 2 axes with Analog option (voltage inputs)	2400

ACCESSORIES

item	description	item no.
SMX91	Programming cable SCU	1010
SXxxx-x	Terminal connector, screw terminals (set), encoded for cabling SDU-21A	on request
SXxxx-x	Terminal connector, spring terminals (set), encoded for cabling SDU-21A	on request

SOFTWARE

item	description	item no.
SafePLC ² 1st	Programming software, 1te License incl. Hardlock	1244
SafePLC ² 2nd	Programming software, 2te License incl. Hardlock	1646
SafePLC ² 3rd	Programming software, 3te License incl. Hardlock	1647

SDU-22

SCU_{SERIES} » SCU Slaves



DESCRIPTION

FSoE slave module for safe speed and position of up to 2 axes for further evaluation in a FSoE master module

- 14 Safe digital inputs
- Up to 4 safe digital outputs
- 8 Encoder interfaces
- 2 Relay / pulse outputs
- 2 Auxiliary outputs
- Safety controller up to PL e acc. to EN ISO 13849-1 or SIL3 acc. to IEC 61508

CHARACTERISTIC OF THE MODULE

- » Decentralized safe axle assembly for the EtherCAT environment
- » Safe detection of speed and position of up to two axes
- » Fast response time with integrated Fast Channel Task with guaranteed processing time of 2 ms
- » Complete speed and position-related safety functions for drive monitoring IEC 61800-5-2 integrated into firmware
- » Speed monitoring
- » RPM-monitoring
- » Standstill monitoring
- » Sense of rotation monitoring
- » Safe incremental dimension
- » Emergency Stop monitoring
- » Position monitoring
- » Position range monitoring
- » Trend range monitoring
- » Target position monitoring
- » Pulse outputs for cross-shortening detection of digital input signals
- » External contact monitoring of connected switchgear (EMU)
- » Monitored relay outputs for safety-relevant functions
- » Switchable safe semi-conductor outputs pn-, pp-switching for safety-relevant functions
- » Functionplan-oriented parametrization
- » Parameter management for expansion modules in base device
- » Comprehensive diagnostics functions integrated
- » Coded status display via front-side 7-segment display and status LEDs
- » Allows the connection of 2 rotary encoders per axis (SSI, SinCos, TTL, Proxy);
2nd encoder interface also supports HTL (200 kHz), SinCos High-Resolution and Resolver

Appendix: data sheets SCU Slaves

SDU-22
SCU_{SERIES} » SCU Slaves



SAFETY RELATED CHARACTERISTIC DATA

Performance Level	PL e (EN ISO 13849-1)
PFH / architecture	2,0* 10 ⁻⁹ / Cat. 4
Safety Integrity Level	SIL 3 (IEC 61508)
Proof test interval	20 years = max. operating period

GENERAL DATA

Max. no. of expansion modules	–
Interface for expansion modules	RJ-45 (Ethernet)
Number of safe digital inputs	14
Number of safe digital outputs	
	pp-switching * 4
	pn-switching * 2
Number of safe digital I/O	–
Number of relay outputs	2
Number of safe analogue inputs	–
Number of auxiliary outputs	2
Number of pulse outputs (clock outputs)	2
Type of connection	Plug-in terminals with spring or screw connection
Axis monitoring	2
Encoder interfaces (D-Sub / screw terminals)	4 / 4 **
Encoder technology (See Encoder specifications)	<p>D-SUB Enc 1.1 / Enc 2.1 SSI-Absolut, SinCos, Incremental-TTL</p> <p>D-SUB Enc 1.2 / Enc 2.2 SSI-Absolut, SinCos (HighRes), Incremental-TTL, Resolver</p> <p>Terminals (X27, X28 / X29, X30): Incremental-HTL (200kHz)</p> <p>Terminal (X23): HTL proximity sensor (10kHz)</p>
Cycle time PLC	8 ms
Fast Channel	2 ms
Safe Slave	FSoE

* pn/pp are configurable via SafePLC²

** maximum 2 encoder / axis

Appendix: data sheets SCU Slaves

SDU-22
SCU_{SERIES} » SCU Slaves

BBH
PRODUCTS

ELECTRICAL DATA

Supply voltage (tolerance)		24 VDC; 2A (-10%, +20%)
Fuse	X11.1 / 24+	min. 30 VDC; max. 3,15A
	X11.2 / AQ1+	min. 30 VDC; max. 10A
Max. Power consumption (logic)	SDU-22	5,4 W
Rated data digital inputs		24 VDC; 20 mA Typ1 acc. to IEC 61131-2
Rated data digital outputs		
	pn-switching	24 VDC; 2A *
	pp-switching	24 VDC; 2A *
	auxiliary outputs	24 VDC; 250mA
	pulse outputs (clock outputs)	24 VDC; 250mA
Rated data relays		
	Normally open	DC 13
		24 VDC; 2A
		AC 15
		230 VAC; 2A

DERATING OUTPUTS

- » Maximum current load based on temperature.
- » The maximum total current is 10A.

type of module	outputs	temperature 30°C / 50°C
SDU-22	QX 00 – QX 03	2A / 1,8A

2A outputs can be fully loaded at an ambient temperature of up to 30°C. From a ambient temperature from 30°C to maximum 50°C, the 2A outputs can be loaded to a maximum of 1.8A.

The maximum total current is 10A. (IO-Board)

Appendix: data sheets SCU Slaves

SDU-22 SCU_{SERIES} » SCU Slaves



ENVIRONMENTAL DATA

Temperature	0°C ... +50°C operation
	-25°C ... +70°C storage and transport
Class of protection	IP 20
Climatic category	3K3 acc. to DIN EN 60721-3
Min-, Maximum relative humidity (no condensation)	5% - 85%
EMC	DIN EN 61000-6-2, DIN EN 61000-6-4, DIN EN 61000-6-7, DIN EN 61800-3, DIN EN 61326-3, DIN EN 62061
Operating altitude	2000m

MECHANICAL DATA

Dimension (HxDxW [mm])	SDU-22	100x115x135
Weight [g]	SDU-22	620
Mounting		to snap on top-hat rail
Min. terminal cross-section / AWG		0,2 mm ² / 24
Max. terminal cross-section / AWG		2,5 mm ² / 12

Appendix: data sheets SCU Slaves

SDU-22 SCU SERIES » SCU Slaves



DEVICE INTERFACES

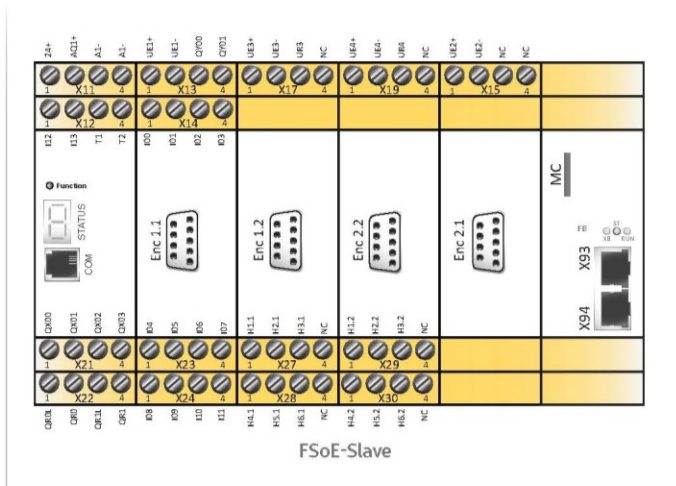

Interface	Description of interface
X11 – X14 / X17 – X24	Voltage supply and I/O interface
COM	Diagnostic- and configuration interface
MC	Memory card for safety program
X93 - ECAT IN / X94 - ECAT OUT	Fieldbus interfaces
X23 / X27 – X30	Encoder interfaces
Enc 1.1 - Enc 2.2	Encoder interfaces

VOLTAGE SUPPLY AND I/O INTERFACE

X11		
Pin	1 - 24+	Voltage supply device +24 VDC
	2 - AQ1+	Voltage supply device +24 VDC outputs
	3 - A1-	Voltage supply device 0 VDC
	4 - A1-	Voltage supply device 0 VDC
X12		
Pin	1 - I12	Safe digital inputs
	2 - I13	
	3 - T1	Clock outputs
	4 - T2	
X21		
Pin	1 - QX00	Safe output pn-/ pp-switching 00
	2 - QX01	Safe output pn-/ pp-switching 01
	3 - QX02	Safe output pn-/ pp-switching 02
	4 - QX03	Safe output pn-/ pp-switching 03
X22		
Pin	1 - QR0L	Safe relay input
	2 - QR0	Safe relay output
	3 - QR1L	Safe relay input
	4 - QR1	Safe relay output

X13		
Pin	1 - UE1+	Voltage supply encoder +24 VDC
	2 - UE1-	
	3 - QY00	Auxiliary outputs
	4 - QY01	
X14		
Pin	1 - I00	Safe digital inputs
	2 - I01	
	3 - I02	
	4 - I03	
X23		
Pin	1 - I04	Safe digital inputs
	2 - I05	
	3 - I06	
	4 - I07	
X24		
Pin	1 - I08	Safe digital inputs
	2 - I09	
	3 - I10	
	4 - I11	
X15		
Pin	1 - UE2+	Voltage supply encoder +24 VDC
	2 - UE2-	
	3 - NC	No function
	4 - NC	No function

Appendix: data sheets SCU Slaves

SDU-22 SCU_{SERIES} » SCU Slaves



X17		
Pin	1 - UE3+	Voltage supply Encoder +24V DC
	2 - UE3-	Voltage supply Encoder 0V DC
	3 - UR3	Reference voltage Encoder
	4 - NC	No function

X19		
Pin	1 - UE4+	Voltage supply Encoder +24V DC
	2 - UE4-	Voltage supply Encoder 0V DC
	3 - UR4	Reference voltage Encoder
	4 - NC	No function

Appendix: data sheets SCU Slaves

SDU-22 SCU_{SERIES} » SCU Slaves



DIAGNOSTIC AND CONFIGURATION INTERFACE

Pin assignment

RJ 10, 4-pin		
Pin	Description	COM front side
1	GND	
2	RS485-	
3	RS485+	
4	VCCH	

» With existing Ethernet-based fieldbus interface, it can be used as a diagnostic and configuration interface.

FIELDBUS INTERFACES

Pin assignment female connector

Safe EtherCAT interface (RJ45)				
Pin	Name	Description	Colour	X93 / X94
1	TX+	Transmit Data +	white-orange	
2	TX-	Transmit Data -	orange	
3	RX+	Receive Data +	white-green	
4	nc	Not used	blue	
5	nc	Not used	white-blue	
6	RX-	Receive Data -	green	
7	nc	Not used	white-brown	
8	nc	Not used	brown	

INTEGRATED COMMUNICATION INTERFACE

» The integrated communication interface of the FSoE slave includes a safe EtherCAT interface for decentralized communication with an FSoE-Master unit.

General data

Fieldbus interface	X93 / X94	EtherCAT	2x RJ 45
Memory Card (safety program)	MC		1x Mini SD (front side)
Status LED`s			3

Appendix: data sheets SCU Slaves

SDU-22 SCUSERIES » SCU Slaves



ENCODER INTERFACES

Pin assignment Enc 1.1 / Enc 2.1 , Enc 1.2 / Enc 2.2

Pin	Enc 1.1 / Enc 2.1 Inc / Sin/Cos / SSI	Enc 1.2 / Enc 2.2 Inc / Sin/Cos / SSI	Enc 1.2 / Enc 2.2 Resolver	Front side SDU
1	n.c.	n.c.	Ref_Out +	
2	GND_ENC	GND_ENC	GND_ENC	
3	n.c.	n.c. / n.c. / Clk +	Ref_In +	
4	B - / COS - / Clk -	B - / COS - / n.c.	COS -	
5	A + / SIN + / Data +	A + / SIN + / Data +	SIN +	
6	A - / SIN - / Data -	A - / SIN - / Data -	SIN -	
7	n.c.	n.c. / n.c. / Clk -	Ref -	
8	B + / COS + / Clk +	B + / COS + / n.c.	COS +	
9	U_ENC	U_ENC	U_ENC	

Pin assignment X23 , X27 / X29 , X28 / X30

Pin	Z1 - Z1 / Z2 - Z2	Terminals
1	A (\bar{A}) / A (\bar{A})	X23
2	-- / B (\bar{B})	
3	A (\bar{A}) / A (\bar{A})	
4	-- / B (\bar{B})	

Pin	A+/A-	A+ Signal	X27 / X29
1 - H1.1 (1.2)	A +	24V	
2 - H2.1 (2.2)	A -	A	
3 - H3.1 (3.2)	A +	GND	
4 - NC	—	—	

Pin	B+/B-	B+ Signal	X28 / X30
1 - H4.1 (4.2)	B +	24V	
2 - H5.1 (5.2)	B -	B	
3 - H6.1 (6.2)	B +	GND	
4 - NC	—	—	

ENCODERSPECIFICATIONS

Incremental - TTL

Physical Layer	RS-422 compatible
Measuring signal A/B	Track with 90 degree phase difference
Type of connection	D-SUB 9pole
Max. frequency of input cycles (Enc 1.1, Enc 2.1 / Enc 1.2, Enc 2.2)	200 kHz / 250 kHz

Sin/Cos

Physical Layer	RS-422 compatible
Measuring signal A/B	Track with 90 degree phase difference
Type of connection	D-SUB 9pole

Standard Mode

Max. frequency of input clock pulses (Enc 1.1, Enc 2.1 / Enc 1.2, Enc 2.2)	200 kHz / 250 kHz
---	-------------------

High Resolution Mode

Max. frequency of input clock pulses (Enc 1.2, Enc 2.2)	15 kHz
--	--------

Appendix: data sheets SCU Slaves

SDU-22
SCU_{SERIES} » SCU Slaves

BBH
PRODUCTS

SSI-Absolut

Data interface	Serial Synchronous Interface (SSI) with variable data length of 12 – 28 Bit
Data format	Binary, Gray code
Physical Layer	RS-422 compatible
Type of connection	D-SUB 9pole
Mode	Listener
SSI-Listener Mode	
Clock rate (Enc 1.1, Enc 2.1 / Enc 1.2, Enc 2.2)	100 kHz ... 200 kHz / 100 kHz ... 350 kHz
Min. clock pause time	150 µsec
Max. clock pause time	1 msec

Resolver

Measuring signal	Sin/Cos – track with 90 degree phase difference
Signal frequency	max. 600 Hz (900 Hz Deep pass)
Input voltage	max. 8 V _{ss} (at 4,7 kΩ)
Resolution	9 Bit / pole
Supported pole number	2 - 16
Type of connection (Enc 1.2, Enc 2.2)	D-SUB 9-pole
Mode	Listener
Resolver-Listener operation	
Reference frequency	4 kHz – 16 kHz
Reference amplitude	8 V _{ss} – 28 V _{ss}
Reference signal form	Sinusoidal, triangle, rectangle
Transformation ratio	2:1; 3:2; 4:1
Phase fault	max. 8°

Incremental - HTL

Signal level	24V / 0V
Physical Layer	PUSH / PULL
Max. counting pulse frequency	200 kHz
Type of connection (X27, X28, X29, X30)	Plug-in terminals with spring or screw connection

HTL proximity sensor

Signal level	24V / 0V
Max. counting pulse frequency (circuit logic de-bounced)	10 kHz
Pulse width	50 µsec
Type of connection (X23)	Plug-in terminals with spring or screw connection

HTL proximity switch - extended monitoring

Signal level	24V / 0V
Max. counting frequency (circuit logic de-bounced)	4 kHz
Physical Layer	PUSH / PULL
Measuring signal A/B	Track with 90 degree phase difference
Type of connection (X23)	Plug-in terminals with spring or screw connection

Appendix: data sheets SCU Slaves

SDU-22

SCU_{SERIES} » SCU Slaves



ORDER INFORMATION

FSoE SLAVES

item	description	item no.
SDU-22	Decentralized axis expansion module for 2 axes	2397

ACCESSORIES

item	description	item no.
SMX91	Programming adapter	1010
SXxxx-x	Terminal connector, screw terminals (set), encoded for cabling SDU-22	on request
SXxxx-x	Terminal connector, spring terminals (set), encoded for cabling SDU-22	on request

SOFTWARE

item	description	item no.
SafePLC ² 1st	Programming software, 1te License incl. Hardlock	1244
SafePLC ² 2nd	Programming software, 2te License incl. Hardlock	1646
SafePLC ² 3rd	Programming software, 3te License incl. Hardlock	1647

Appendix: data sheets SCU Slaves

SDU-22A

SCU_{SERIES} » SCU Slaves

BBH
PRODUCTS

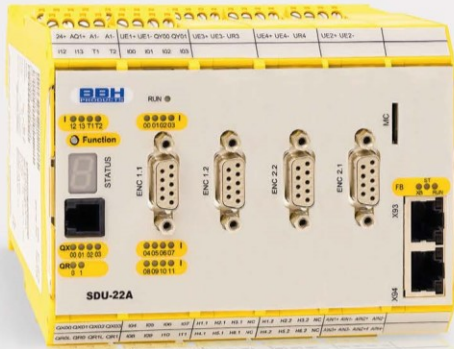

DESCRIPTION

FSoE slave module for safe speed and position of up to 2 axes for further evaluation in an FSoE master module

- 14 safe digital inputs
- Up to 4 safe digital outputs
- 8 Encoder interfaces
- 2 Analog inputs
- 2 Relay / pulse outputs
- 2 Auxiliary outputs
- Safety controller up to PL e acc. to EN ISO 13849-1 or SIL3 acc. to IEC 61508

CHARACTERISTIC OF THE MODULE

- » Decentralized safe axle assembly for the EtherCAT environment
- » Safe detection of speed and position of up to two axes
- » Fast response time with integrated Fast Channel Task with guaranteed processing time of 2 ms
- » Complete speed and position-related safety functions for drive monitoring IEC 61800-5-2 integrated into firmware
- » Speed monitoring
- » RPM-monitoring
- » Standstill monitoring
- » Sense of rotation monitoring
- » Safe incremental dimension
- » Emergency Stop monitoring
- » Position monitoring
- » Position range monitoring
- » Trend range monitoring
- » Target position monitoring
- » Pulse outputs for cross-shorting detection of digital input signals
- » External contact monitoring of connected switchgear (EMU)
- » Monitored relay outputs for safety-relevant functions
- » Switchable safe semi-conductor outputs pn-, pp-switching for safety-relevant functions
- » Functionplan-oriented parametrization
- » Parameter management for expansion modules in base device
- » Comprehensive diagnostics functions integrated
- » Coded status display via front-side 7 segment display and status LEDs
- » Allows the connection of 2 rotary encoders per axis (SSI, SinCos, TTL, Proxy)
- » 2nd encoder interface also supports HTL (200 kHz), SinCos High-Resolution and Resolver

Appendix: data sheets SCU Slaves

SDU-22A SCU_{SERIES} » SCU Slaves



SAFETY RELATED CHARACTERISTIC DATA

Performance Level	PL e (EN ISO 13849-1)
PFH / architecture	2,0* 10 ⁻⁹ / Cat. 4
Safety Integrity Level	SIL 3 (IEC 61508)
Proof test interval	20 years = max. operating period

GENERAL DATA

Max. no. of expansion modules	–
Interface for expansion modules	RJ-45 (Ethernet)
Number of safe digital inputs	14
Number of safe digital outputs	
	pp-switching * 4
	pn-switching * 2
Number of safe digital I/O	–
Number of relay outputs	2
Number of safe analogue inputs	2 ***
Number of auxiliary outputs	2
Number of pulse outputs (clock outputs)	2
Type of connection	Plug-in terminals with spring or screw connection
Axis monitoring	2
Encoder interfaces (D-Sub / screw terminals)	4 / 4 **
Encoder technology (See Encoder specifications)	D-SUB Enc 1.1 / Enc 2.1: SSI-Absolut, SinCos, Incremental-TTL D-SUB Enc 1.2 / Enc 2.2: SSI-Absolut, SinCos (HighRes), Incremental-TTL, Resolver Terminals (X27, X28 / X29, X30): Incremental-HTL (200kHz) Terminal (X23): HTL proximity sensor (10kHz)
Cycle time PLC	8 ms
Fast Channel	2 ms
Safe Slave	FSoE

* pn/pp are configurable via SafePLC²

** maximum 2 encoder / axis

*** Analogue electricity, voltage inputs are available as options

SDU-22A-U Voltage inputs

SDU-22A-I current inputs

SDU-22A Voltage and current inputs

Appendix: data sheets SCU Slaves

SDU-22A

SCU_{SERIES} » SCU Slaves



ELECTRICAL DATA

Supply voltage (tolerance)		24 VDC; 2A (-10%, +20%)	
Fuse	X11.1 / 24+	min. 30 VDC; max. 3,15A	
	X11.2 / AQ1+	min. 30 VDC; max. 10A	
Max. Power consumption (logic)	SDU-22A	5,4 W	
Rated data digital inputs		24 VDC; 20 mA Typ1 acc. to IEC 61131-2	
Rated data digital outputs			
	pn-switching	24 VDC; 2A *	
	pp-switching	24 VDC; 2A *	
	auxiliary outputs	24 VDC; 250mA	
	pulse outputs (clock outputs)	24 VDC; 250mA	
Rated data relays			
	Normally open	DC 13	24 VDC; 2A
		AC 15	230 VAC; 2A
Rated data analogue inputs			
	SDU-22A		-7 ... +10 V 4 ... 20 mA

DERATING OUTPUTS

- » Maximum current load based on temperature.
- » The maximum total current is 10A.

type of module	outputs	temperature 30°C / 50°C
SDU-22A	QX 00 – QX 03	2A / 1,8A

2A outputs can be fully loaded at an ambient temperature of up to 30°C. From a ambient temperature from 30°C to maximum 50°C, the 2A outputs can be loaded to a maximum of 1,8A.

The maximum total current is 10A. (IO-Board)

Appendix: data sheets SCU Slaves

SDU-22A

SCU_{SERIES} » SCU Slaves



ENVIRONMENTAL DATA

Temperature	0°C ... +50°C operation
	-25°C ... +70°C storage and transport
Class of protection	IP 20
Climatic category	3K3 acc. to DIN EN 60721-3
Min-, Maximum relative humidity (no condensation)	5% - 85%
EMC	DIN EN 61000-6-2, DIN EN 61000-6-4, DIN EN 61000-6-7, DIN EN 61800-3, DIN EN 61326-3, DIN EN 62061
Operating altitude	2000m

MECHANICAL DATA

Dimension (HxDxW [mm])	SDU-22A	100x115x135
Weight [g]	SDU-22A	620
Mounting		to snap on top-hat rail
Min. terminal cross-section / AWG		0,2 mm ² / 24
Max. terminal cross-section / AWG		2,5 mm ² / 12

Appendix: data sheets SCU Slaves

SDU-22A SCU SERIES » SCU Slaves



DEVICE INTERFACES

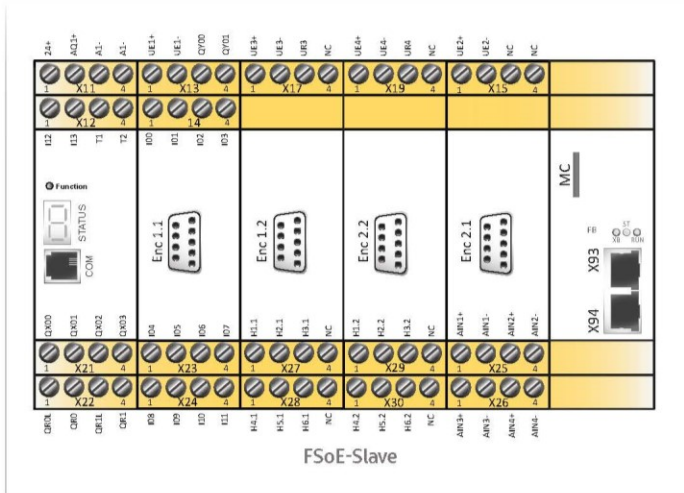

Interface	Description of interface
X11 – X14 / X17 – X26	Voltage supply and I/O interface
COM	Diagnostic- and configuration interface
MC	Memory Card for safety program
X93 -ECAT IN / X94 -ECAT OUT	Fieldbus interfaces
X23 / Enc 1.1	Encoder interfaces
Enc 1.2 - Enc 2.2	Encoder interfaces

VOLTAGE SUPPLY AND I/O INTERACE

X11		
Pin	1 - 24+	Voltage supply device +24 VDC
	2 - AQ1+	Voltage supply device +24 VDC outputs
	3 - A1- 4 - A1-	Voltage supply device 0 VDC
X12		
Pin	1 - I12	Safe digital inputs
	2 - I13	
	3 - T1	Clock outputs
	4 - T2	
X21		
Pin	1 - QX00	Safe output pn-/ pp-switching 00
	2 - QX01	Safe output pn-/ pp-switching 01
	3 - QX02	Safe output pn-/ pp-switching 02
	4 - QX03	Safe output pn-/ pp-switching 03
X22		
Pin	1 - QR0L	Safe relay input
	2 - QR0	Safe relay output
	3 - QR1L	Safe relay input
	4 - QR1	Safe relay output

X13		
Pin	1 - UE1+	Voltage supply Encoder +24 VDC
	2 - UE1-	Voltage supply Encoder 0 VDC
	3 - QY00 4 - QY01	Auxiliary outputs
X14		
Pin	1 - I00	Safe digital inputs
	2 - I01	
	3 - I02	
	4 - I03	
X23		
Pin	1 - I04	Safe digital inputs
	2 - I05	
	3 - I06	
	4 - I07	
X24		
Pin	1 - I08	Safe digital inputs
	2 - I09	
	3 - I10	
	4 - I11	

Appendix: data sheets SCU Slaves

SDU-22A

SCUSERIES » SCU Slaves



X17		
Pin	1 - UE3+	Voltage supply Encoder +24 VDC
	2 - UE3-	Voltage supply Encoder 0 VDC
	3 - UR3	Reference voltage Encoder
	4 - NC	No function
X19		
Pin	1 - UE4+	Voltage supply Encoder +24 VDC
	2 - UE4-	Voltage supply Encoder 0 VDC
	3 - UR4	Reference voltage Encoder
	4 - NC	No function
X15		
Pin	1 - UE3+	Voltage supply Encoder +24V DC
	2 - UE3-	Voltage supply Encoder 0 VDC
	3 - NC	No function
	4 - NC	No function

X25 (voltage inputs)		
Pin	1 - AIN 1+	Safe analog input
	2 - AIN 1-	
	3 - AIN 2+	Safe analog input
	4 - AIN 2-	
X26 (current inputs)		
Pin	1 - AIN 3+	Safe analog input
	2 - AIN 3-	
	3 - AIN 4+	Safe analog input
	4 - AIN 4-	

Appendix: data sheets SCU Slaves

SDU-22A

SCU_{SERIES} » SCU Slaves

BBH
PRODUCTS

DIAGNOSTIC AND CONFIGURATION INTERFACE

Pin assignment

RJ 10, 4-pin		
Pin	Description	COM front side
1	GND	
2	RS485-	
3	RS485+	
4	VCCH	

» With existing Ethernet-based fieldbus interface, it can be used as a diagnostic and configuration interface.

FIELDBUS INTERFACES

Pin assignment female connector

EtherCAT interface (RJ45)				
Pin	Name	Description	Colour	X93 / X94
1	TX+	Transmit Data +	white-orange	
2	TX-	Transmit Data -	orange	
3	RX+	Receive Data +	white-green	
4	nc	Not used	blue	
5	nc	Not used	white-blue	
6	RX-	Receive Data -	green	
7	nc	Not used	white-brown	
8	nc	Not used	brown	

INTEGRATED COMMUNICATION INTERFACE

» The integrated communication interface of the FSoE slave includes a safe EtherCAT interface for decentralized communication with an FSoE-Master unit.

General data			
Fieldbus interface			
X93 / X94	EtherCAT	2x RJ 45	
Memory Card (safety program)			
	MC	1x Mini SD (front side)	
Status LED`s		3	

Appendix: data sheets SCU Slaves

SDU-22A SCU_{SERIES} » SCU Slaves



ENCODER INTERFACES

Pin assignment Enc 1.1 / Enc 2.1 , Enc 1.2 / Enc 2.2

Pin	Enc 1.1 / Enc 2.1 Inc / Sin/Cos / SSI	Enc 1.2 / Enc 2.2 Inc / Sin/Cos / SSI	Enc 1.2 / Enc 2.2 Resolver	Front side SDU
1	n.c.	n.c.	Ref_Out +	
2	GND_ENC	GND_ENC	GND_ENC	
3	n.c.	n.c. / n.c. / Clk +	Ref_In +	
4	B - / COS - / Clk -	B - / COS - / n.c.	COS -	
5	A + / SIN + / Data +	A + / SIN + / Data +	SIN +	
6	A - / SIN - / Data -	A - / SIN - / Data -	SIN -	
7	n.c.	n.c. / n.c. / Clk -	Ref -	
8	B + / COS + / Clk +	B + / COS + / n.c.	COS +	
9	U_ENC	U_ENC	U_ENC	

Pin assignment X23 , X27 / X28 , X29 / X30

Pin	Z1 - Z1 / Z2 - Z2	Terminals
1	A (\bar{A}) / A (\bar{A})	
2	-- / B (\bar{B})	
3	A (\bar{A}) / A (\bar{A})	
4	-- / B (\bar{B})	

Pin	A+/A-	A+ Signal	Terminals
1 - H1A	A +	24V	
2 - H2A	A -	A	
3 - H3A	A +	GND	
4 - NC	—	—	

Pin	B+/B-	B+ Signal	Terminals
1 - H1B	B +	24V	
2 - H2B	B -	B	
3 - H3B	B +	GND	
4 - NC	—	—	

ENCODERSPECIFICATIONS

Incremental - TTL

Physical Layer	RS-422 compatible
Measuring signal A/B	Track with 90 degree phase difference
Type of connection	D-SUB 9-pole
Max. frequency of input cycles (Enc 1.1, Enc 2.1 / Enc 1.2, Enc 2.2)	200 kHz / 250 kHz

Sin/Cos

Physical Layer	RS-422 compatible
Measuring signal A/B	Track with 90 degree phase difference
Type of connection	D-SUB 9-pole

Standard Mode

Max. frequency of input clock pulses (Enc 1.1, Enc 2.1 / Enc 1.2, Enc 2.2)	200 kHz / 250 kHz
---	-------------------

High Resolution Mode

Max. frequency of input clock pulses (Enc 1.2, Enc 2.2)	15 kHz
--	--------

Appendix: data sheets SCU Slaves

SDU-22A
SCU_{SERIES} » SCU Slaves

BBH
PRODUCTS

SSI-Absolut

Data interface	Serial Synchronous Interface (SSI) with variable data length of 12 – 28 Bit
Data format	Binary, Gray code
Physical Layer	RS-422 compatible
Type of connection	D-SUB 9pole
Mode	Listener
SSI-Listener Mode	
Clock rate (Enc 1.1, Enc 2.1 / Enc 1.2, Enc 2.2)	100 kHz ... 200 kHz / 100 kHz ... 350 kHz
Min. clock pause time	150 µsec
Max. clock pause time	1 msec

Resolver

Measuring signal	Sin/Cos – track with 90 degree phase difference
Signal frequency	max. 600 Hz (900 Hz Deep pass)
Input voltage	max. 8 V _{ss} (at 4,7 kΩ)
Resolution	9 Bit / pole
Supported pole number	2 - 16
Type of connection (Enc 1.2, Enc 2.2)	D-SUB 9-pole
Mode	Listener
Resolver-Listener operation	
Reference frequency	4 kHz – 16 kHz
Reference amplitude	8 V _{ss} – 28 V _{ss}
Reference signal form	Sinusoidal, triangle, rectangle
Transformation ratio	2:1; 3:2; 4:1
Phase fault	max. 8°

Incremental - HTL

Signal level	24V / 0V
Physical Layer	PUSH / PULL
Max. counting pulse frequency	200 kHz
Type of connection (X27, X28, X29, X30)	Plug-in terminals with spring or screw connection

HTL proximity sensor

Signal level	24V / 0V
Max. counting pulse frequency (circuit logic de-bounced)	10 kHz
Pulse width	50 µsec
Type of connection (X23)	Plug-in terminals with spring or screw connection

HTL proximity switch - extended monitoring

Signal level	24V / 0V
Max. counting frequency (circuit logic de-bounced)	4 kHz
Physical Layer	PUSH / PULL
Measuring signal A/B	Track with 90 degree phase difference
Type of connection (X23)	Plug-in terminals with spring or screw connection

Appendix: data sheets SCU Slaves

SDU-22A

SCU_{SERIES} » SCU Slaves



ORDER INFORMATION

FSoE SLAVES

item	description	item no.
SDU-22A	Decentralized axis expansion module for 2 axes with Analog option (voltage + current inputs)	2401
SDU-22A-I	Decentralized axis expansion module for 2 axes with Analog option (current inputs)	2402
SDU-22A-U	Decentralized axis expansion module for 2 axes with Analog option (voltage inputs)	2403

ACCESSORIES

item	description	item no.
SMX91	Programming adapter	1010
SXxxx-x	Terminal connector, screw terminals (set), encoded for cabling SDU-22A	on request
SXxxx-x	Terminal connector, spring terminals (set), encoded for cabling SDU-22A	on request

SOFTWARE

item	description	item no.
SafePLC ² 1st	Programming software, 1te License incl. Hardlock	1244
SafePLC ² 2nd	Programming software, 2te License incl. Hardlock	1646
SafePLC ² 3rd	Programming software, 3te License incl. Hardlock	1647

SIO-1

SCUSERIES » SCU Slaves » I/O

BBH
PRODUCTS



DESCRIPTION

FSoE slave module for the decentralised expansion of a FSoE master module (SCUMASTER - modules)

- 14 Safe digital inputs
- 2 Relay outputs
- 2 Pulse outputs
- 2/4 pn- or pp-switching outputs
- Safety controller up to PL e acc. to EN ISO 13849-1 or SIL3 acc. to IEC 61508

CHARACTERISTIC OF TH MODULE

- » Decentralised safe I/O Slave module for the EtherCAT environment
- » Pulse outputs for cross-shortening detection of digital input signals
- » External contact monitoring of connected switchgear (EMU)
- » Comprehensive diagnostics functions integrated
- » Multifunction button (quit, start, reset) can be operated from the front side
- » Coded status display via front-side 7 segment display and status LEDs

Appendix: data sheets SCU Slaves

SIO-1

SCUSERIES » SCU Slaves » I/O

BBH
PRODUCTS

SAFETY RELATED CHARACTERISTIC DATA

Performance Level	PL e (EN ISO 13849-1)
PFH ¹⁾ / architecture	9,2 FIT / Cat. 4 *
Safety Integrity Level	SIL 3 (IEC 61508)
Proof test interval	20 years = max. operating period

GENERAL DATA

Max. no. of expansion modules	–
Interface for expansion modules	RJ-45 (Ethernet)
Number of safe digital inputs	14
Number of safe digital outputs	–
	pp-switching ** 4
	pn-switching ** 2
Number of safe digital I/O	–
Number of relay outputs	2
Number of safe analogue inputs	–
Number of auxiliary outputs	–
Number of pulse outputs (clock outputs)	2
Type of connection	Plug-in terminals with spring or screw connection
Axis monitoring	–
Encoder interfaces (D-Sub / screw terminals)	–

* Value applies only for extension module.

** pn/pp are configurable via SafePLC²

¹⁾ For total assessment in accordance with EN ISO 13849-1 one must use a series connection with the corresponding basic device > $PFH_{Logic} = PFH_{Basic} + PFH_{Extension}$

Appendix: data sheets SCU Slaves

SIO-1

SCU_{SERIES} » SCU Slaves » I/O

BBH PRODUCTS

ELECTRICAL DATA

Supply voltage (tolerance)		24 VDC; 2A (-15%, +20%)
Fuse	X41.1 / 24+	min. 30 VDC; max. 3,15 A
	X41.2 / AQ1+	min. 30 VDC; max. 10A
Max. Power consumption (logic)	SIO-1	4,2 W
Rated data digital inputs		24 VDC; 20 mA, Typ1 acc. to IEC 61131-2
Rated data digital outputs		
	pn-switching	24 VDC; 2A *
	pp-switching	24 VDC; 2A *
	pulse outputs (clock outputs)	24 VDC; 250mA
Rated data relays		
Normally open	DC 13	24 VDC; 2A
	AC 15	230 VAC; 2A
Normally closed (Readback contact)	DC 13	24 VDC; 2A

* see „Derating outputs“

DERATING OUTPUTS

- » Maximum current load based on temperature.
- » The maximum total current is 10A.

type of module	outputs	temperature 30°C / 50°C
SIO-1	QX 00 – QX 03	2A / 1,8A

2A outputs can be fully loaded at an ambient temperature of up to 30°C. From a ambient temperature from 30°C to maximum 50°C, the 2A outputs can be loaded to a maximum of 1.8A.

The maximum total current is 10A. (IO-Board)

Appendix: data sheets SCU Slaves

SIO-1

SCU_{SERIES} » SCU Slaves » I/O

BBH
PRODUCTS

ENVIRONMENTAL DATA

Temperature	0°C ... +50°C operation
	-25°C ... +70°C storage and transport
Class of protection	IP 20
Climatic category	3K3 acc. to DIN EN 60721-3
Min-, Maximum relative humidity (no condensation)	5% - 85%
EMC	DIN EN 61000-6-2, DIN EN 61000-6-4, DIN EN 61000-6-7, DIN EN 61800-3, DIN EN 61326-3, DIN EN 62061
Operating altitude	2000m

MECHANICAL DATA

Dimensions (HxDxW [mm])	SIO-1	100x115x45
Weight [g]	SIO-1	320
Mounting		to snap on top-hat rail
Number of T-Bus	SIO-1	2
Min. terminal cross-section / AWG		0,2 mm ² / 24
Max. terminal cross-section / AWG		2,5 mm ² / 12

Appendix: data sheets SCU Slaves

SIO-1

SCUSERIES » SCU Slaves » I/O



DEVICE INTERFACES

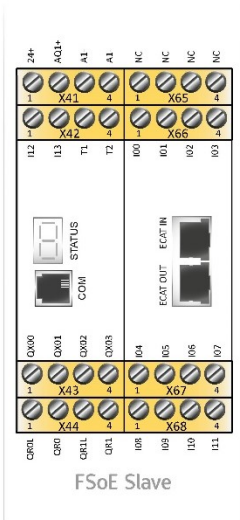

Interface	Description of interface
X41 – X44 / X65 – X68	Voltage supply and I/O interface
COM	Diagnostic- and configuration interface
ECAT IN / OUT	Fieldbus interfaces *

* configurable via SafePLC²

VOLTAGE SUPPLY AND I/O INTERACE

X 41		
Pin	1 - 24+	Volatge supply device +24 VDC
	2 - AQ1+	Voltage supply device +24 VDC outputs
	3 - A1-	Voltage supply device 0 VDC
	4 - A1-	Voltage supply device 0 VDC
X 42		
Pin	1 - I12	Safe digital inputs
	2 - I13	
	3 - T1	Clock outputs
	4 - T2	
X 43		
Pin	1 - QX00	Safe output pn-/ pp-switching Q1
	2 - QX01	Safe output pn-/ pp-switching Q2
	3 - QX02	Safe output pn-/ pp-switching Q3
	4 - QX03	Safe output pn-/ pp-switching Q4
X 44		
Pin	1 - QR0L	Safe relay input
	2 - QR0	Safe relay output
	3 - QR1L	Safe relay input
	4 - QR1	Safe relay output

X 65		
Pin	1 - NC	No function
	2 - NC	
	3 - NC	
	4 - NC	
X 66		
Pin	1 - I00	Safe digital inputs
	2 - I01	
	3 - I02	
	4 - I03	
X 67		
Pin	1 - I04	Safe digital inputs
	2 - I05	
	3 - I06	
	4 - I07	
X68		
Pin	1 - I08	Safe digital inputs
	2 - I09	
	3 - I10	
	4 - I11	

Appendix: data sheets SCU Slaves

SIO-1

SCUSERIES » SCU Slaves » I/O



DIAGNOSTIC AND CONFIGURATION INTERFACE

Pin assignment

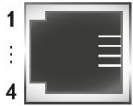
RJ 10, 4-pin		
Pin	Description	COM front side
1	GND	
2	RS485-	
3	RS485+	
4	VCCH	

» With existing Ethernet-based fieldbus interface, it can be used as a diagnostic and configuration interface.

FIELDBUS INTERFACES

Pin assignment female connector

EtherCAT interface / optional Ethernet-based fieldbus interface (RJ45)				
Pin	Name	Description	Colour	EtherCAT IN / OUT
1	TX+	Transmit Data +	white-orange	
2	TX-	Transmit Data -	orange	
3	RX+	Receive Data +	white-green	
4	nc	Not used	blue	
5	nc	Not used	white-blue	
6	RX-	Receive Data -	green	
7	nc	Not used	white-brown	
8	nc	Not used	brown	

Appendix: data sheets SCU Slaves

SIO-1

SCU_{SERIES} » SCU Slaves » I/O

BBH
PRODUCTS

ORDER INFORMATION

FSoE SLAVES

item	description	item no.
SIO-1	Decentralized FSoE-I/O expansion module	2234

ACCESSORIES

item	description	item no.
SXxxx-x	Terminal connector, screw terminals (set), encoded for cabling SIO-1	on request
SXxxx-x	Terminal connector, spring terminals (set), encoded for cabling SIO-1	on request
SMX91	Programming adapter	1010

SIO-2

SCUSERIES » SCU Slaves » I/O

BBH
PRODUCTS



DESCRIPTION

FSoE IO-slave module for the decentralized expansion of a FSoE master module (SCUMASTER - modules)

- 14 Safe digital inputs
- Up to 20 safe digital I/Os
- 2 Relay / 2 Pulse outputs
- 2/4 pn- or pp-switching outputs
- Safety controller up to PL e acc. to EN ISO 13849-1 or SIL3 acc. to IEC 61508

CHARACTERISTIC OF THE MODULE

- » Decentralized safe I/O-Slave module for the EtherCAT environment
- » Pulse outputs for cross-shortening detection of digital input signals
- » External contact monitoring of connected switchgear (EMU)
- » Comprehensive diagnostics functions integrated
- » Coded status display via front-side 7 segment display and status LEDs
- » Multifunction button (quit, start, reset) can be operated from the front side
- » Up to 20 safe I/O - configured as inputs or outputs

Appendix: data sheets SCU Slaves

SIO-2

SCU_{SERIES} » SCU Slaves » I/O

BBH PRODUCTS

SAFETY RELATED CHARACTERISTIC DATA

Performance Level	PL e (EN ISO 13849-1)
PFH ¹⁾ / architecture	PFH = 7,96*10 ⁻⁹ / Cat. 4 *
	MTTFd = 126 years = high
	DCavg = high
Safety Integrity Level	SIL 3 (IEC 61508)
Proof test interval	20 years = max. operating period

GENERAL DATA

Max. no. of expansion modules	-
Interface for expansion modules	RJ-45 (Ethernet), Communication interface (/D)
Number of safe digital inputs	14
Number of safe digital outputs	-
	pp-switching ** 4
	pn-switching ** 2
Number of safe digital I/O	20
Number of relay outputs	2
Number of safe analogue inputs	-
Number of auxiliary outputs	-
Number of pulse outputs (clock outputs)	2
Type of connection	Plug-in terminals with spring or screw connection
Axis monitoring	-
Encoder interfaces (D-Sub / screw terminals)	-
Safe slave	FSoE

* Value applies only for extension module

** pn/pp are configurable via SafePLC²

¹⁾ For total assessment in accordance with EN ISO 13849-1 one must use a series connection with the corresponding basic device => $PFH_{Logic} = PFH_{Basic} + PFH_{Extension}$

Appendix: data sheets SCU Slaves

SIO-2

SCUSERIES » SCU Slaves » I/O

BBH PRODUCTS

ELECTRICAL DATA

Supply voltage (tolerance)		24 VDC; 2A (-15%, +20%)
Fuse	X41.1 / 24+	min. 30 VDC; max. 3,15 A
	X41.2 / AQ1+, X45.1 / AQ2+, X49.1 / AQ3+	min. 30 VDC; max. 10A
Max. Power consumption (logic)	SIO-2	3,1 W
Rated data digital inputs		24 VDC; 20 mA, Typ1 acc. to IEC 61131-2
Rated data digital outputs		
	pn-switching	24 VDC; 2A *
	pp-switching	24 VDC; 2A *
	pulse outputs (clock outputs)	24 VDC; 250mA
	safe digital I/O	
	00 - 04 10 - 14	24 VDC; 0,5A
	05 - 09 15 - 19	24 VDC; 2A *
Rated data relays		
	Normally open	DC 13 24 VDC; 2A
		AC 15 230 VAC; 2A
	Normally closed (Readback contact)	DC 13 24 VDC; 2A

* see „Derating outputs“

DERATING OUTPUTS

- » Maximum current load based on temperature.
- » The maximum total current is 10A.

type of module	outputs	temperature 30°C / 50°C
SIO-2	QX 00 – QX 03 / IQx5 – IQx9	2A / 1,8A

2A outputs can be fully loaded at an ambient temperature of up to 30°C. From a ambient temperature from 30°C to maximum 50°C, the 2A outputs can be loaded to a maximum of 1.8A.

The maximum total current is 10A. (IO-Board)

Appendix: data sheets SCU Slaves

SIO-2

SCU_{SERIES} » SCU Slaves » I/O

BBH
PRODUCTS

ENVIRONMENTAL DATA

Temperature	0°C ... +50°C operation
	-25°C ... +70°C storage and transport
Class of protection	IP 20
Climatic category	3K3 acc. to DIN EN 60721-3
Min-, Maximum relative humidity (no condensation)	5% - 85%
EMC	DIN EN 61000-6-2, DIN EN 61000-6-4, DIN EN 61000-6-7, DIN EN 61800-3, DIN EN 61326-3, DIN EN 62061
Operating altitude	2000m

MECHANICAL DATA

Dimension (HxDxW [mm])	SIO-2	100x115x90
Weight [g]	SIO-2	512
Mounting		to snap on top-hat rail
Number of T-Bus	SIO-2	4
Min. terminal cross-section / AWG		0,2 mm ² / 24
Max. terminal cross-section / AWG		2,5 mm ² / 12

Appendix: data sheets SCU Slaves

SIO-2

SCUSERIES » SCU Slaves » I/O



DEVICE INTERFACES

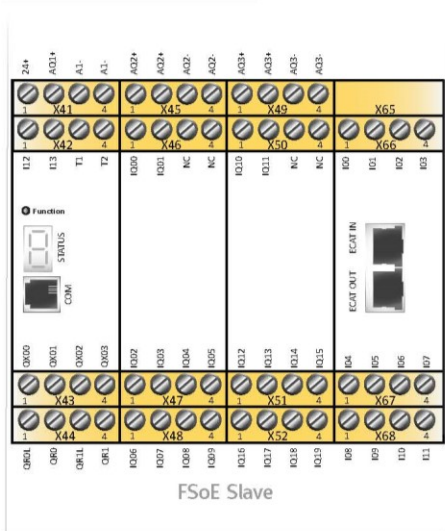

Interface	Description of interface
X41 – X52 / X65 – X68	Voltage supply and I/O interface
COM	Diagnostic- and configuration interface
ECAT IN / OUT	Fieldbus interfaces *

* configurable via SafePLC²

VOLTAGE SUPPLY AND I/O INTERACE

X 41		
Pin	1 - 24+	Voltage supply device +24 VDC
	2 - AQ1+	Voltage supply device +24 VDC outputs
	3 - A1-	Voltage supply device 0 VDC
	4 - A1-	Voltage supply device 0 VDC
X 42		
Pin	1 - I12	Safe digital inputs
	2 - I13	
	3 - T1	Clock outputs
	4 - T2	
X 43		
Pin	1 - QX00	Safe output pn-/ pp-switching 00
	2 - QX01	Safe output pn-/ pp-switching 01
	3 - QX02	Safe output pn-/ pp-switching 02
	4 - QX03	Safe output pn-/ pp-switching 03
X 44		
Pin	1 - QR0L	Safe relay input
	2 - QR0	Safe relay output
	3 - QR1L	Safe relay input
	4 - QR1	Safe relay output

X45		
Pin	1 - AQ2+	Voltage supply device +24 VDC
	2 - AQ2+	
	3 - AQ2-	Voltage supply 0 VDC
	4 - AQ2-	
X 46		
Pin	1 - IQ00	Safe digital inputs, outputs
	2 - IQ01	
	3 - NC	No function
	4 - NC	
X47		
Pin	1 - IQ02	Safe digital inputs, outputs
	2 - IQ03	
	3 - IQ04	
	4 - IQ05	
X48		
Pin	1 - IQ06	Safe digital inputs, outputs
	2 - IQ07	
	3 - IQ08	
	4 - IQ09	

Appendix: data sheets SCU Slaves

SIO-2

SCU_{SERIES} » SCU Slaves » I/O

BBH PRODUCTS

X49		
Pin	1 - AQ3+	Voltage supply device +24 VDC
	2 - AQ3+	
	3 - AQ3-	Voltage supply 0 VDC
	4 - AQ3-	
X50		
Pin	1 - IQ10	Safe digital inputs, outputs
	2 - IQ11	
	3 - NC	No function
	4 - NC	
X51		
Pin	1 - IQ12	Safe digital inputs, outputs
	2 - IQ13	
	3 - IQ14	
	4 - IQ15	
X52		
Pin	1 - IQ16	Safe digital inputs, outputs
	2 - IQ17	
	3 - IQ18	
	4 - IQ19	

X65		
Pin	1 - NC	No function
	2 - NC	
	3 - NC	
	4 - NC	
X66		
Pin	1 - I00	Safe digital inputs
	2 - I01	
	3 - I02	
	4 - I03	
X67		
Pin	1 - I04	Safe digital inputs
	2 - I05	
	3 - I06	
	4 - I07	
X68		
Pin	1 - I08	Safe digital inputs
	2 - I09	
	3 - I10	
	4 - I11	

Appendix: data sheets SCU Slaves

SIO-2

SCUSERIES » SCU Slaves » I/O



DIAGNOSTIC AND CONFIGURATION INTERFACE

Pin assignment

RJ 10, 4-pin		
Pin	Description	COM front side
1	GND	
2	RS485-	
3	RS485+	
4	VCCH	

» With existing Ethernet-based fieldbus interface, it can be used as a diagnostic and configuration interface.

FIELDBUS INTERFACES

Pin assignment female connector

EtherCAT interface (RJ45)				
Pin	Name	Description	Colour	EtherCAT IN / OUT
1	TX+	Transmit Data +	white-orange	
2	TX-	Transmit Data -	orange	
3	RX+	Receive Data +	white-green	
4	nc	Not used	blue	
5	nc	Not used	white-blue	
6	RX-	Receive Data -	green	
7	nc	Not used	white-brown	
8	nc	Not used	brown	

Appendix: data sheets SCU Slaves

SIO-2

SCU_{SERIES} » SCU Slaves » I/O



ORDER INFORMATION

FSoE SLAVES

item	description	item no.
SIO-2	Decentralized FSoE I/O-Slave module + 20 safe I/Os	2235

ACCESSORIES

item	description	item no.
SXxxx-x	Terminal connector, screw terminals (set), encoded for cabling SIO-2	on request
SXxxx-x	Terminal connector, spring terminals (set), encoded for cabling SIO-2	on request
SMX91	Programming adapter	1010

SSB-X
SCU_{SERIES} » SCU Slaves

BBH
PRODUCTS

DESCRIPTION



FSoE slave module for safe speed and Position of up to 6 axes for further evaluation in an FSoE master module

- Depending on the encoder type and combination, applications up to PL e or SIL3 can be realized
- Update time minimal up to 1 ms
- 1 ms for safe data; 62,5 μ s for non-safe encoder values
- Optional additional safe inputs and outputs

CHARACTERISTIC OF THE MODULE

- » Safe detection of speed and position for up to 6 axes suitable for applications up to SIL3 (IEC 61508) / PL e (EN ISO 13849-1)
- » Parametrial interface for digital and analog digital encoders
- » With an update time of minimal up to 1ms, applications with a high dynamic security requirement can also be implemented
- » Time resolution 1 ms for safe data of speed and position, 62.5 μ s for non-safe encoder values
- » Optional: additional safe inputs and outputs (8/8)
- » The mechanical construction of the SSB-x* is dependent on the respective forms of the module

Appendix: data sheets SCU Slaves

SSB-X
SCU SERIES » SCU Slaves

BBH
PRODUCTS

SAFETY RELATED CHARACTERISTIC DATA

Performance Level	PL e (EN ISO 13849-1)	
PFH / architecture	EnDat 2.2	DSL
MTTFd	1,713*10 ⁻⁸ / Cat. 4	1,795*10 ⁻⁸ / Cat.4
DCavg	43 years	41,7 years
Safety Integrity Level	high	high
Proof test interval	SIL 3 (IEC 61508)	
	20 years = max. operating period	

GENERAL DATA

Number of safe digital inputs (optional)	8
Number of safe digital outputs (optional)	8
Resolution of safe speed	2 ¹⁶
Resolution secure position	2 ²⁴
Resolution non-safe position	up to 2 ⁴⁸
Cycle time safe data	Min 1 ms
Cycle time non-safe data	Min 62,5 µs
Number of pulse outputs (clock outputs)	2
Type of Connection	plug connection
Encoder	M8-plug
EtherCAT fieldbus interface	M12-plug
Supply voltage I/O	M12-plug
Supply voltage device	M12-plug
Axis monitoring (axis / encoder interfaces)	
	SSB-3-x 3 / 6
	SSB-6-x 6 / 6
Encoder technology*	EnDAT 2.2, Hiperface DSL, Digital-analogue Encoder technology: SINCOS/ Resolver (in preparation)
Encoder voltage supplies (monitoring)	5 V, 8V, 10V, 12V, 20V, 24V

* see „ encoder specifications“

Appendix: data sheets SCU Slaves

SSB-X
SCU_{SERIES} » SCU Slaves

BBH
PRODUCTS

ELECTRICAL DATA

Supply voltage	19,2 V ... 30 V, Type SELV / PELV	
Fuse	device supply	8A
	brake supply	8A
Max. Power consumption (logic)	SSB-x	3 W
Rated data digital inputs	24 VDC; 20 mA, Type1 acc. to EN 61131-2	
Rated data digital outputs	4x 0,5A, 5x 1A, 1x 2A	
	2x	SDO_7 - 8 0,5 A (leakage current <1,2 mA)
	5x	SDO_1 - 5 1 A (leakage current < 5 mA)
	1x	SDO_6 2 A (leakage current < 5mA)
		pulse outputs (clock outputs) 2x 0,5 A
Securing of voltage supply device / outputs	2A / 10 A	

ENVIRONMENTAL DATA

Temperature	0°C ... +50°C operation -25°C ... +70°C storage and transport	
Classs of protection	IP 67	
Climatic category	3K3 acc. to DIN EN 60721-3	
Min-, Maximum relative humidity (no condensation))	5% - 85%	
EMC	DIN EN 55011, DIN EN 61000-6-2, DIN EN 61131-2:2007	

MECHANICAL DATA

Dimension (HxDxW [mm])	SSB-x	ca. 64x176x170mm
Weight [g]	SSB-x	720
Mounting	mounting plate	

Appendix: data sheets SCU Slaves

SSB-X
SCU_{SERIES} » SCU Slaves

BBH
PRODUCTS

DEVICE INTERFACES

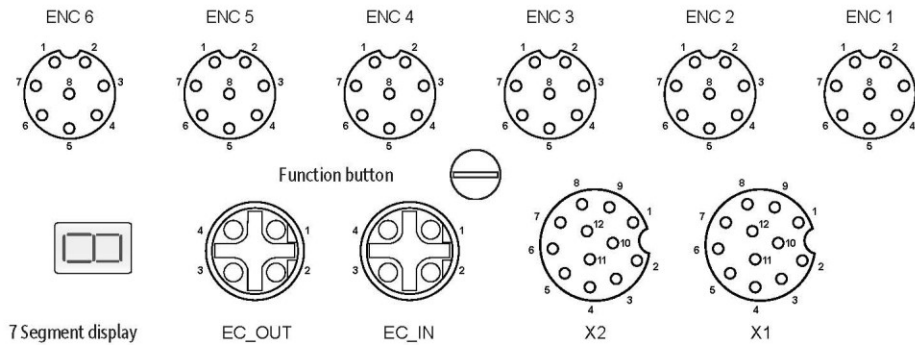

PIN ASSIGNMENTS SSB-6-EnDat-x¹⁾

EC_IN		
Pin	1 - TX1_P	Transmit Data +
	2 - RX1_P	Receive Data +
	3 - TX1_N	Transmit Data -
	4 - RX1_N	Receive Data -
EC_OUT		
Pin	1 - TX2_P	Transmit Data +
	2 - RX2_P	Receive Data +
	3 - TX2_N	Transmit Data -
	4 - RX2_N	Receive Data -
ENC 1-6 ²⁾		
Pin	1 - ENC_x_DATA_P	Encoder Data input +
	2 - ENC_x_DATA_N	Encoder Data input -
	3 - ENC_x_CLK_P	Encoder Clock +
	4 - ENC_x_CLK_N	Encoder Clock -
	5 - UB_ENC_x	Voltage supply encoder +24 VDC
	6 - UE-	Voltage supply encoder 0 VDC
	7 - SDO_x	Safe digital output (optional)
	8 - GND	Ground

X2 (optional) ²⁾		
Pin	1 - SDO_7	Safe digital outputs
	2 - SDO_8	Safe digital outputs
	3 - T1	Clock outputs
	4 - T2	
	5 - AQ-	Voltage supply Safe Outputs 0 VDC
	6 - AQ+	Voltage supply Safe Outputs +24 VDC
	7 - AQ+	
	8 - AQ+	Voltage supply Safe Outputs +24 VDC
	9 - AQ+	
	10 - AQ-	Voltage supply Safe Outputs 0 VDC
	11 - AQ-	
	12 - AQ-	

X1 ²⁾		
Pin	1 - SDI_1	Safe digital Inputs (optional)
	2 - SDI_2	
	3 - SDI_3	Safe digital Inputs (optional)
	4 - SDI_4	
	5 - SDI_5	Safe digital Inputs (optional)
	6 - SDI_6	
	7 - SDI_7	Safe digital Inputs (optional)
	8 - SDI_8	
	9 - GND	Voltage supply device 0 VDC
	10 - U24+	Voltage supply device +24 VDC
	11 - U24+	
	12 - GND	Voltage supply device 0 VDC

x = 1 ... 6

¹⁾ = SSB-6-EnDat-IO: with I/O's, SSB-6-EnDat: without I/O's

²⁾ = optional available with I/O's

Appendix: data sheets SCU Slaves

SSB-x
SCU_{SERIES} » SCU Slaves

BBH
PRODUCTS

DEVICE INTERFACES

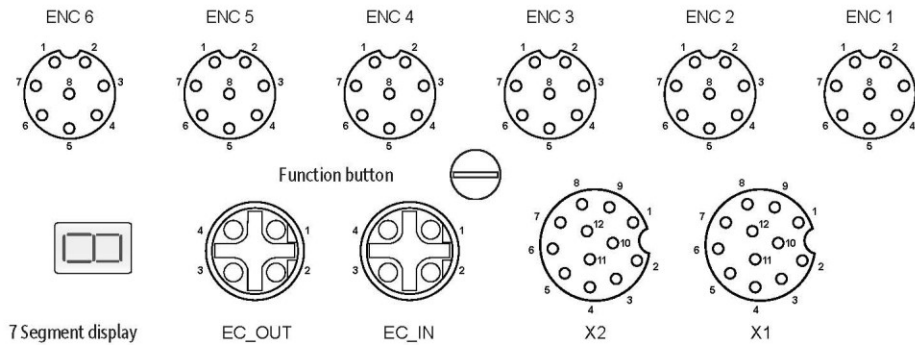

PIN ASSIGNMENTS SSB-6-DSL-x¹⁾

EC_IN			X2 (optional) ²⁾			X1 ²⁾		
Pin	1 - TX1_P	Transmit Data +	1 - SDO_7	Safe digital outputs	Pin	1 - SDI_1	Safe digital Inputs (optional)	
	2 - RX1_P	Receive Data +	2 - SDO_8			2 - SDI_2		
	3 - TX1_N	Transmit Data -	3 - T1	Clock outputs		3 - SDI_3	Safe digital Inputs (optional)	
	4 - RX1_N	Receive Data -	4 - T2			4 - SDI_4		
EC_OUT			5 - AQ-	Voltage supply Safe Outputs 0 VDC	5 - SDI_5	Safe digital Inputs (optional)		
Pin	1 - TX2_P	Transmit Data +	6 - AQ+	Voltage supply Safe Outputs +24 VDC	6 - SDI_6			
	2 - RX2_P	Receive Data +	7 - AQ+		Voltage supply Safe Outputs +24 VDC	7 - SDI_7	Safe digital Inputs (optional)	
	3 - TX2_N	Transmit Data -	8 - AQ+	Voltage supply Safe Outputs +24 VDC		8 - SDI_8		
	4 - RX2_N	Receive Data -	9 - AQ+		Voltage supply Safe Outputs 0 VDC	9 - GND	Voltage supply device 0 VDC	
ENC 1-6 ²⁾			10 - AQ-	Voltage supply Safe Outputs 0 VDC		10 - U24+	Voltage supply device +24 VDC	
Pin	1 - DSLx_P	Encoder Data input +	11 - AQ-		Voltage supply Safe Outputs 0 VDC	11 - U24+		
	2 - DSLx_N	Encoder Data input -	12 - AQ-	Voltage supply device 0 VDC		12 - GND		
	3 - NC							
	4 - NC	No function						
	5 - NC							
	6 - GND	Ground						
	7 - SDO_x	Safe digital Outputs (optional)						
	8 - NC	No function						

x = 1 ... 6

¹⁾ = **SSB-6-DSL-I0**: with I/O's, **SSB-6-DSL**: without I/O's

²⁾ = optional available with I/O's

Appendix: data sheets SCU Slaves

SSB-x
SCU_{SERIES} » SCU Slaves

BBH
PRODUCTS

DEVICE INTERFACES

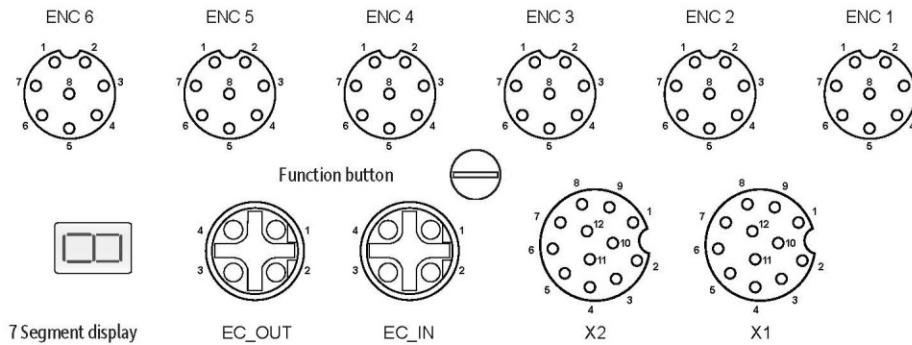

PIN ASSIGNMENTS SSB-6-A-x¹⁾

EC_IN			X2 (optional) ²⁾			X1 ²⁾		
Pin	1 - TX1_P	Transmit Data +	1 - SDO_7	Safe digital outputs	Pin	1 - SDL_1	Safe digital Inputs (optional)	
	2 - RX1_P	Receive Data +	2 - SDO_8			2 - SDL_2		
	3 - TX1_N	Transmit Data -	3 - T1	Clock outputs		3 - SDL_3	Safe digital Inputs (optional)	
	4 - RX1_N	Receive Data -	4 - T2			4 - SDL_4		
EC_OUT			5 - AQ-	Voltage supply Safe Outputs 0 VDC	5 - SDL_5	Safe digital Inputs (optional)		
Pin	1 - TX2_P	Transmit Data +	6 - AQ+	Voltage supply Safe Outputs +24 VDC	6 - SDL_6			
	2 - RX2_P	Receive Data +	7 - AQ+		Voltage supply Safe Outputs +24 VDC	7 - SDL_7	Safe digital Inputs (optional)	
	3 - TX2_N	Transmit Data -	8 - AQ+	Voltage supply Safe Outputs +24 VDC		8 - SDL_8		
	4 - RX2_N	Receive Data -	9 - AQ+		Voltage supply Safe Outputs 0 VDC	9 - GND	Voltage supply device 0 VDC	
ENC 1-6 ²⁾			10 - AQ-	Voltage supply Safe Outputs 0 VDC		10 - U24+		Voltage supply device +24 VDC
Pin	1 - ENC_SIN +	Encoder SIN +	11 - AQ-		Voltage supply Safe Outputs 0 VDC	11 - U24+		
	2 - ENC_SIN -	Encoder SIN -	12 - AQ-	Voltage supply device 0 VDC				
	3 - ENC_COS +	Encoder COS +						
	4 - ENC_COS -	Encoder COS -						
	5 - UB_V+ / Ref +	Voltage supply encoder / reference + +24 VDC						
	6 - UB_V- / Ref -	Voltage supply encoder / reference - 0 VDC						
	7 - SDO_x	Safe digital outputs (optional)						
	8 - GND	Ground						

x = 1 ... 6

¹⁾ = SSB-6-A-IO: with I/O's, SSB-6-A: without I/O's

²⁾ = optional available with I/O's

Appendix: data sheets SCU Slaves

SSB-X
SCU_{SERIES} » SCU Slaves

BBH
PRODUCTS

ENCODER SPECIFICATIONS

EnDAT 2.2

Standard specification	Mixed / Clk+ Date
Encoder type	EQI1131, ECI1119, ECI1319
Resolution	12 bit multi turn (only EQI) 19 bit single turn for non-safe position 10 bit single turn for safe position
Clock frequency	10 MHz
Cable length	20 m
Sampling cycle	Non-safe position: 62,5 µs, safe position. 1 ms
Transmission of non-safe position (EtherCAT)	62,5 µs / 125 µs / 250 µs (configurable)

Hiperface DSL

Standard specification	Mixed / Clk+ Date
Encoder type	EKM36-2KF0A018A EKM36-2KF0A020A EKS36-2KF0A018A
Resolution	11 bit / 12 bit multi turn (only EKM) 18 bit / 20 bit single turn for non-safe position 9 bit single turn for safe position
Cable length	100 m
Sampling cycle	Non-safe position: 125 µs, safe position. 1 ms
Transmission of non-safe position (EtherCAT)	125 µs / 250 µs (configurable)

SinCos / TTL

Amplitude SinCos	1 VSS + / - 0,3 V
Phase fault	max. 30°
Type of connection	M8-plug

High Resolution Mode

Max. Frequenz der Eingangstakte	500 kHz
Physical Layer	± 0.5Vss (without voltage offset)
Measuring signal A/B	Track with 90 degree Phase difference

in preparation

SSI-Absolut

Data interface	Serial Synchronous Interface (SSI) with variable data length of 12 – 28 bits
Data format	Binary, gray-code
Type of connection	M8-plug
Mode	Master or Listener
SSI-Master operation	
clock rate	250 - 1500 kHz
SSI-Listener operation	
clock rate	250 - 1500 kHz
Max frame length/data length	32 / 28
Pos. user data	adjustable

in preparation

Appendix: data sheets SCU Slaves

SSB-X
SCUSERIES » SCU Slaves

BBH
PRODUCTS

Resolver		in preparation
Measuring signal A/B	SIN/COS-track with 90 degree Phase difference	
Input	max. 16 VSS (an 16 Ω)	
Resolution	9 Bit / Pol	
Support poles	2 - 16	
Type of connection	M8-plug	
Mode	Master or Listener	
Resolver-Master operation		
Reference frequency	8 kHz	
Resolver-Listener operation		
Reference frequency	4 kHz - 16 kHz	
Reference amplitude	8 VSS - 28 VSS	
Reference signal	Sinusoidal, triangle	
Transmission ratio	2:1, 3:1, 4:1	
Phase fault	max. 8°	

ENCODER COMBINATIONS

		2. Encoder				
		1. Encoder	none	SSI	SinCos	Resolver
6-axis	EnDAT 2.2	V/P ¹⁾				
	Hiperface DSL	V/P ¹⁾				
	SinCos	V ²⁾				
	Resolver	V				
	TTL ⁴⁾	V ³⁾				
3-axis	EnDAT 2.2		V/P	V/P	V/P	V/P
	Hiperface DSL		V/P	V/P	V/P	V/P
	SSI ⁴⁾		V/P	V/P	V/P	V/P
	SinCos ⁴⁾			V	V	V
	Resolver ⁴⁾			V	V	V
	TTL ⁴⁾			V	V	V

SIL2/PL d

SIL3/PL e

V safe speed

P safe position

¹⁾ SIL3/PL e in preparation

²⁾ SIL3/PL e only in conjunction with qualified encoder types

³⁾ Only allowed for dynamic monitoring (no standstill monitoring)

⁴⁾ in preparation

Appendix: data sheets SCU Slaves

SSB-x
SCU_{SERIES} » SCU Slaves

BBH
PRODUCTS

ORDER INFORMATIONS

SLAVES

	item	description	item no.
	SSB-6-EnDAT	FSoE Slave, Axes expansion module 6 Axes, EnDat2.2, without IO	1656
	SSB-6-EnDAT-IO	FSoE Slave, Axes expansion module 6 Axes, EnDat2.2 with IO	on request
	SSB-6-DSL	FSoE Slave, Axes expansion module 6 Axes, HiperfaceDSL, without IO	1665
	SSB-6-DSL-IO	FSoE Slave, Axes expansion module 6 Axes, HiperfaceDSL, with IO	on request
in preparation	SSB-6-A	FSoE Slave, Axes expansion module 6 Axes, SinCos / resolver, without IO	on request
in preparation	SSB-6-A-IO	FSoE Slave, Axes expansion module 6 Axes, SinCos / resolver, with IO	on request

Appendix: technical data SCU series » Dimension Drawing

Technical data

SCU_{SERIES} » SCU Master

BBH
PRODUCTS

DIMENSION DRAWING

SCU-x-EC

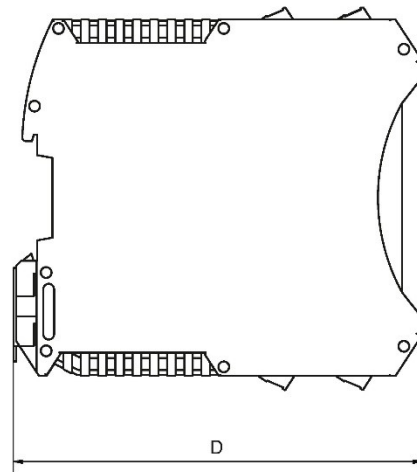
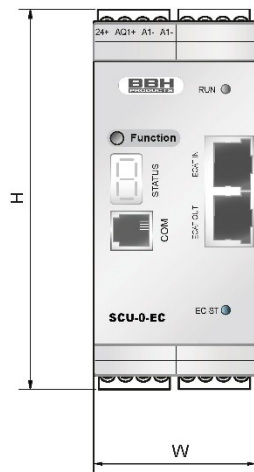

SCU series			
SCU Master	Dimension (HxDxW [mm])	Weight [g]	Mounting
SCU-0-EC	100x115x45	162	to snap on top-hat rail
SCU-1-EC	100x115x45	312	

Appendix: technical data SCU series » Dimension Drawing

Technical data

SCU_{SERIES} » SCU Master



DIMENSION DRAWING

SCU-x-EC/NM

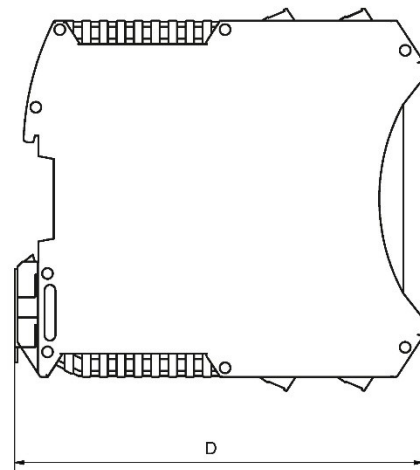
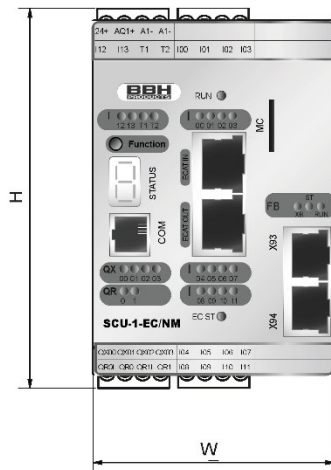

SCU series			
SCU Master	Dimension (HxDxW [mm])	Weight [g]	Mounting
SCU-0-EC/NM	100x115x67,5	248	to snap on top-hat rail
SCU-1-EC/NM	100x115x67,5	398	

Appendix: technical data SCU series » Dimension Drawing

Technical data

SCU_{SERIES} » SCU Master



DIMENSION DRAWING

SCU-2-EC

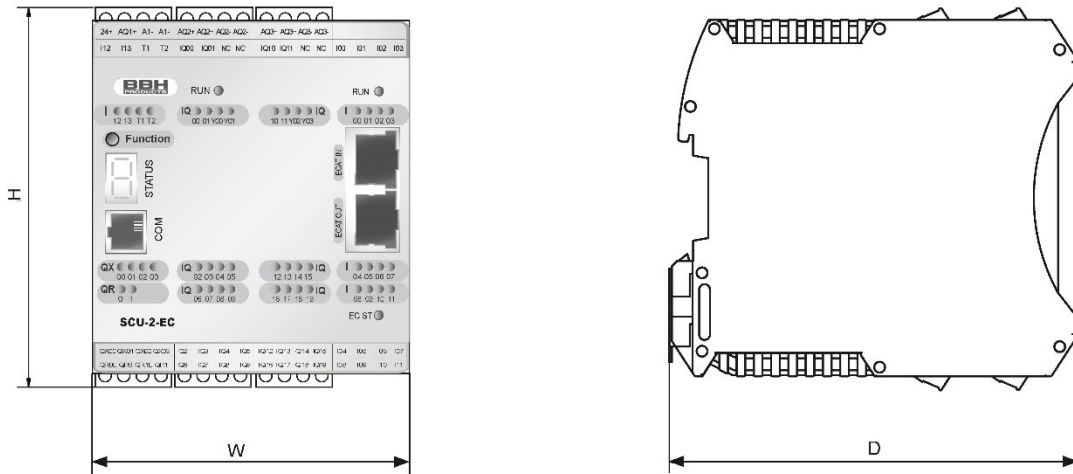

SCU series			
SCU Master	Dimension (HxDxW [mm])	Weight [g]	Mounting
SCU-2-EC	100x115x90	512	to snap on top-hat rail

Appendix: technical data SCU series » Dimension Drawing

Technical data

SCUSERIES » SCU Master



DIMENSION DRAWING

SCU-2-EC/NM

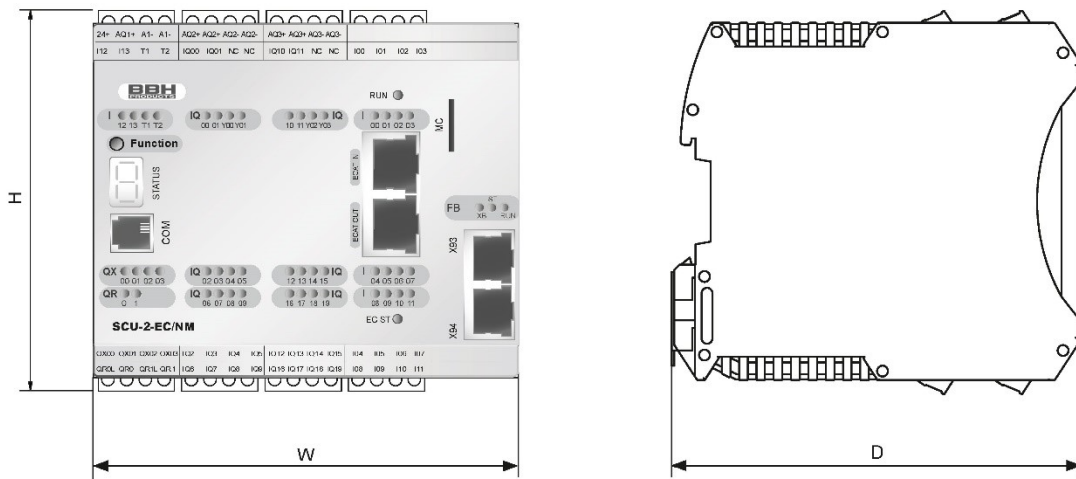

SCU series			
SCU Master	Dimension (HxDxW [mm])	Weight [g]	Mounting
SCU-2-EC/NM	100x115x112,5	602	to snap on top-hat rail

Appendix: technical data SCU series » Dimension Drawing

Technical data

SCUSERIES » SCU Slaves



DIMENSION DRAWING

SDU-1x

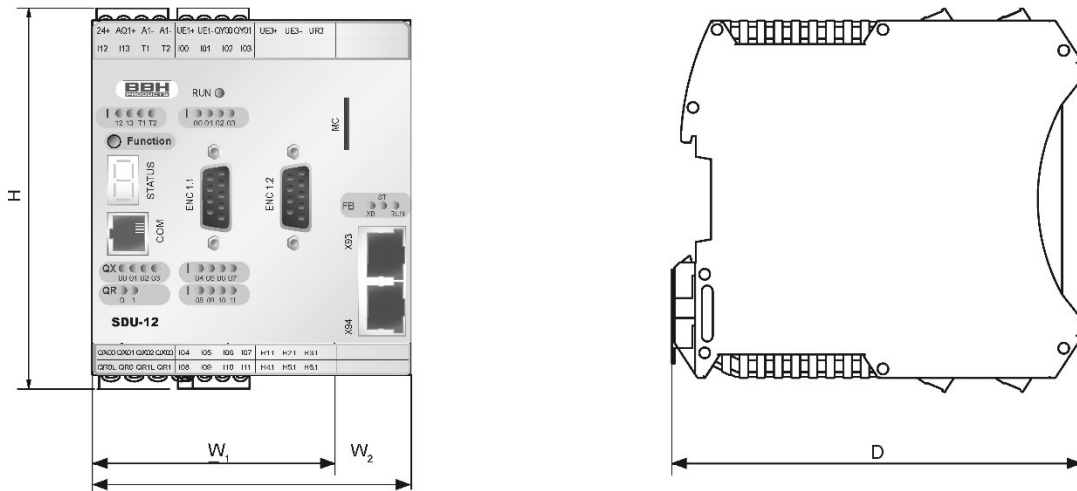

SCU series			
SCU Slaves	Dimension (HxDxW [mm])	Weight [g]	Mounting
SDU-11	100x115x67,5	390	to snap on top-hat rail
SDU-11/NM	100x115x67,5	390	
SDU-11-PXV	100x115x90	490	to snap on top-hat rail
SDU-12	100x115x90	410	

Appendix: technical data SCU series » Dimension Drawing

Technical data

SCUSERIES » SCU Slaves

BBH
PRODUCTS

DIMENSION DRAWING

SDU-2x

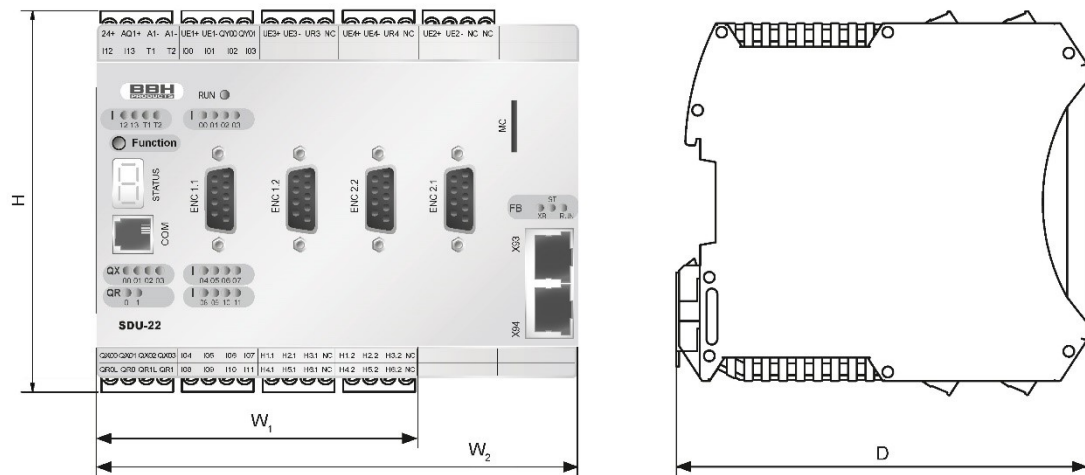

SCU series			
SCU Slaves	Dimension (HxDxW [mm])	Weight [g]	Mounting
SDU-21	100x115x90	410	to snap on top-hat rail
SDU-21A	100x115x90	410	
SDU-22	100x115x135	620	to snap on top-hat rail
SDU-22A	100x115x135	620	

Appendix: technical data SCU series » Dimension Drawing

Technical data

SCUSERIES » SCU Slaves



DIMENSION DRAWING

SIO-x

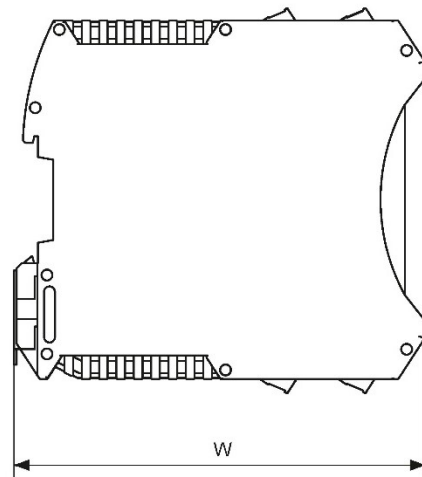
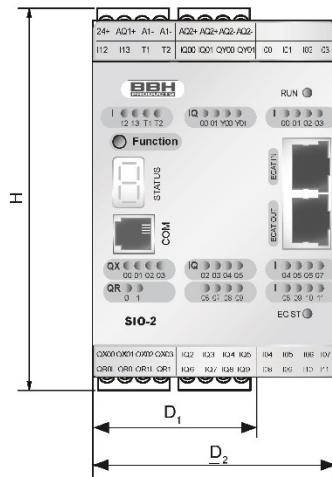

SCU series			
SCU Slaves	Dimension (HxDxW [mm])	Weight [g]	Mounting
SIO-1	100x115x45	320	to snap on top-hat rail
SIO-2	100x115x67,5	460	